

# Linea Color GigE

## Camera User's Manual

Color CMOS Line Scan

sensors | **cameras** | frame grabbers | processors | software | vision solutions



P/N: 03-032-20237-04  
[www.teledynedalsa.com](http://www.teledynedalsa.com)

 **TELEDYNE DALSA**  
Everywhereyoulook™

## **Notice**

© 2018 Teledyne DALSA

All information provided in this manual is believed to be accurate and reliable. No responsibility is assumed by Teledyne DALSA for its use. Teledyne DALSA reserves the right to make changes to this information without notice. Reproduction of this manual in whole or in part, by any means, is prohibited without prior permission having been obtained from Teledyne DALSA.

Microsoft and Windows are registered trademarks of Microsoft Corporation in the United States and other countries. Windows, Windows 7, Windows 8 are trademarks of Microsoft Corporation.

All other trademarks or intellectual property mentioned herein belong to their respective owners.

Document date: 14 August 2018

Document number: 03-032-20237-04

## **About Teledyne DALSA**

Teledyne DALSA is an international high performance semiconductor and electronics company that designs, develops, manufactures, and markets digital imaging products and solutions, in addition to providing wafer foundry services.

Teledyne DALSA Digital Imaging offers the widest range of machine vision components in the world. From industry-leading image sensors through powerful and sophisticated cameras, frame grabbers, vision processors and software to easy-to-use vision appliances and custom vision modules.

# Contents

<b>LINEA COLOR GIGE SERIES OVERVIEW .....</b>	<b>4</b>
DESCRIPTION .....	4
<i>Linea GigE Application Advantages</i> .....	5
<i>Linea GigE with TurboDrive</i> .....	5
<i>Linea GigE Firmware</i> .....	5
PART NUMBERS AND SOFTWARE REQUIREMENTS .....	7
GIGE VISION SAPERA APPLICATION DESCRIPTION .....	8
CAMERA SPECIFICATIONS OVERVIEW .....	9
<i>Environmental Specifications</i> .....	10
<i>Compliance, EMI Certifications</i> .....	10
<i>Flash Memory Size</i> .....	10
SENSOR PERFORMANCE: .....	11
<i>Sensor Specifications</i> .....	11
<i>Spectral Responsivity:</i> .....	12
SPATIAL CORRECTION AND BILINEAR SENSOR DESIGN .....	12
<i>Parallax Correction</i> .....	14
<i>Camera Direction</i> .....	15
<b>CONNECTING THE LINEA COLOR GIGE CAMERA.....</b>	<b>16</b>
GIGE NETWORK ADAPTER OVERVIEW .....	16
<i>PAUSE Frame Support</i> .....	16
CONNECT THE LINEA COLOR GIGE CAMERA .....	16
<i>Connectors</i> .....	17
<i>LED Indicators</i> .....	18
<i>Linea GigE IP Configuration Sequence</i> .....	19
PREVENTING OPERATIONAL FAULTS DUE TO ESD .....	20
<b>USING LINEA GIGE WITH THE SAPERA API .....</b>	<b>21</b>
NETWORK AND COMPUTER OVERVIEW .....	21
INSTALLATION .....	24
<i>Procedure</i> .....	24
<i>Camera Firmware Updates</i> .....	24
<i>GigE Server Verification</i> .....	25
<i>GigE Server Status</i> .....	25
OPTIMIZING THE NETWORK ADAPTER USED WITH LINEA GIGE .....	26
<i>Running the Network Configuration Tool</i> .....	26
QUICK STARTUP WITH CAMEXPERT .....	27
<i>About the User Defined Camera Name</i> .....	28
<b>OPERATIONAL REFERENCE .....</b>	<b>30</b>
USING CAMEXPERT WITH LINEA GIGE CAMERAS .....	30
<i>CamExpert Panes</i> .....	30
<i>Creating a Camera Configuration File in the Host</i> .....	32
CAMERA INFORMATION CATEGORY .....	33
<i>Camera Information Feature Descriptions</i> .....	33
<i>Camera Configuration Selection Dialog</i> .....	36
SENSOR CONTROL CATEGORY .....	37

<i>Sensor Control Feature Descriptions</i> .....	37
<i>Gain and Black Level Control Details</i> .....	39
<i>Exposure Controls Details</i> .....	40
I/O CONTROL CATEGORY .....	42
<i>I/O Control Feature Descriptions</i> .....	43
<i>I/O Module Block Diagram</i> .....	48
<i>Trigger Overview</i> .....	49
COUNTER AND TIMER CONTROL CATEGORY .....	53
<i>Counter and Timer Control Feature Description</i> .....	53
<i>Counter and Timer Group Block Diagram</i> .....	57
ADVANCED PROCESSING CONTROL CATEGORY .....	61
<i>Advanced Processing Control Feature Descriptions</i> .....	61
<i>Flat Field Correction Overview</i> .....	65
<i>How to do a FFC Setup via Sopera CamExpert</i> .....	67
IMAGE FORMAT CONTROL CATEGORY .....	78
<i>Image Format Control Feature Description</i> .....	78
<i>Binning</i> .....	82
<b><i>Metadata Format</i></b> .....	83
<i>Internal Test Image Generator</i> .....	84
ACQUISITION AND TRANSFER CONTROL CATEGORY .....	84
<i>Acquisition and Transfer Control Feature Descriptions</i> .....	84
<i>Overview of Transfer Control (TransferControlMode)</i> .....	87
<i>Features that cannot be changed during a Sopera transfer</i> .....	89
EVENT CONTROL CATEGORY .....	90
<i>Event Control Feature Descriptions</i> .....	91
GIGE VISION TRANSPORT LAYER CONTROL CATEGORY .....	96
<i>GigE Vision Transport Layer Feature Descriptions</i> .....	96
<i>Defaults for devicePacketResendBufferSize</i> .....	101
<i>Device UPnP Auto-Discovery Mode Details</i> .....	101
GIGE VISION HOST CONTROL CATEGORY .....	104
FILE ACCESS CONTROL CATEGORY .....	104
<i>File Access Control Feature Descriptions</i> .....	104
<i>File Access via the CamExpert Tool</i> .....	106
DEVICE STREAMING REGISTERS .....	107
<i>Start – End Command Requirements</i> .....	107
<b>NETWORK OVERVIEW &amp; TOOLS</b> .....	<b>108</b>
IP CONFIGURATION MODE DETAILS .....	108
<i>Link-Local Address (LLA)</i> .....	108
<i>DHCP (Dynamic Host Configuration Protocol)</i> .....	109
<i>Persistent IP</i> .....	110
<b>TECHNICAL SPECIFICATIONS</b> .....	<b>112</b>
MECHANICAL SPECIFICATIONS .....	112
<i>Linea Color GigE 2k and 4k</i> .....	112
ADDITIONAL NOTES ON LINEA GIGE IDENTIFICATION AND MECHANICAL .....	113
SENSOR ALIGNMENT SPECIFICATION .....	113
CONNECTORS .....	114
<i>HD15 type Connector Details</i> .....	114
<i>Input Signals Electrical Specifications</i> .....	116
<i>Output Signals Electrical Specifications</i> .....	118
COMPUTER REQUIREMENTS FOR LINEA GIGE CAMERAS .....	119
<i>Host PC System</i> .....	119

<i>Ethernet Switch Requirements</i> .....	119
<i>Ethernet to Fiber-Optic Interface Requirements</i> .....	120
EC & FCC DECLARATIONS OF CONFORMITY .....	121
<b>ADDITIONAL REFERENCE INFORMATION .....</b>	<b>122</b>
LENS SELECTION OVERVIEW .....	122
<i>Lens Mount Types</i> .....	122
<i>Additional Lens Parameters (application specific)</i> .....	126
OPTICAL CONSIDERATIONS .....	127
<i>Illumination</i> .....	127
<i>Light Sources</i> .....	127
<i>Lens Modeling</i> .....	128
<i>Magnification and Resolution</i> .....	128
SENSOR HANDLING INSTRUCTIONS .....	129
<i>Electrostatic Discharge and the Sensor</i> .....	129
<i>Protecting Against Dust, Oil and Scratches</i> .....	129
<i>Cleaning the Sensor Window</i> .....	130
RUGGEDIZED RJ45 ETHERNET CABLES .....	131
<b>TROUBLESHOOTING .....</b>	<b>132</b>
OVERVIEW .....	132
<i>Problem Type Summary</i> .....	132
<i>Verifying Network Parameters</i> .....	134
INSTALLATION ISSUES AND FUNCTIONAL PROBLEMS .....	134
DEVICE AVAILABLE WITH OPERATIONAL ISSUES .....	134
<i>Firmware Updates</i> .....	134
<i>Power Failure During a Firmware Update—Now What?</i> .....	135
<i>Cabling and Communication Issues</i> .....	135
<i>Acquisition Error without Timeout Messages</i> .....	136
<i>Other Problems or Issues</i> .....	137
<b>CONTACT INFORMATION .....</b>	<b>138</b>
SALES INFORMATION .....	138
TECHNICAL SUPPORT .....	138

# Linea Color GigE Series Overview

---

## Description

The Linea Color™ GigE Vision lines can is a new affordable single line, camera delivering speed, responsivity, and color at a competitive price. This small, low power camera is designed for applications such as materials grading and inspection, transportation safety, automated optical inspection and general purpose machine vision.

The Linea Color GigE Vision camera is one of a new series of affordable easy to use digital cameras specifically engineered for industrial imaging applications requiring embedded image processing and improved network integration.

Linea Color GigE combines standard gigabit Ethernet technology (supporting GigE Vision 1.2) with Teledyne DALSA Trigger-to-Image-Reliability, to dependably capture and transfer color images from the camera to the host PC.



## Linea GigE Application Advantages

- Optimized, rugged design
- GigE Vision 1.2 compliant
- Gigabit Ethernet (GigE) interconnection to a computer via standard CAT5e or CAT6 cables
- Supports connection to the host computer NIC through a GigE network switch
- GigE Vision Turbo Drive Technology Module
- Available in 2048 or 4096 pixel line resolutions
- 8 bit output
- High line rates
- 2 general purpose inputs with programmable threshold
- 2 bidirectional I/O
- 2 general purpose outputs
- Counter, Timer, and Events available to support imaging applications
- Native Trigger-to-Image Reliability design
- Visual status LEDs on camera back plate
- Supported by Sapera™ LT software libraries
- Camera power via HD15 GPIO connector
- Support for end-of-line Metadata
- Digital binning for increased sensitivity
- 1  $\mu$ s internal timer or external events can timestamp images
- Provides 4 User Settings sets to store and recall camera configurations
- Refer to the Operation Reference and Technical Specifications section of the manual for full details.

## Linea GigE with TurboDrive

Linea cameras include TurboDrive™ technology, delivering high speed data transfers exceeding the GigE limit\*. TurboDrive uses advanced data modeling to boost data transfers up to 2 or 3 times faster than standard GigE Vision speeds – with no loss of image quality. These breakthrough line rates are achieved using a proprietary, patent-pending process that assembles data from the sensor to optimize throughput, simultaneously taking full advantage of both the sensor's maximum line rate (up to 45 kHz) and the camera's maximum GigE data transfer speed (up to 110 Mbytes/s). TurboDrive increases system dependability and robustness by engaging Linea's full image capture capability—similar to Camera Link throughput on a GigE network.

\*TurboDrive is supported by the Green 8-bit and BicolorRGBG8 pixel formats exclusively.

## Linea GigE Firmware

Teledyne DALSA Linea GigE camera firmware contains open source software provided under different open source software licenses. Information about these open source licenses can be found in the documentation that accompanies the firmware, which is available on the Teledyne DALSA website at [www.teledynedalsa.com](http://www.teledynedalsa.com).

Firmware updates for Linea GigE are available for download from the Teledyne DALSA web site [<http://www.teledynedalsa.com/imaging/support/downloads/firmware/>]. Choose Linea GigE Firmware from the available download sections, then choose the zip file download specific to your camera model. Update the camera firmware using CamExpert (see File Access via the CamExpert Tool).

When using Sopera LT, update the camera firmware using CamExpert (see File Access via the CamExpert Tool). The Camera firmware can also be easily upgrade/downgrade within your own application via the API.



## Part Numbers and Software Requirements

This manual covers the Linea Color GigE models summarized below. New models are added to this manual as they are released by Teledyne DALSA. See “Camera Specifications” on page 9 for details of each Linea GigE model.

Camera	Resolution	Pixel size	Max. Line Rate	Lens Mount (treaded)	Product Number
Linea GigE 2K	2048 x 2	7.04 x 7.04 μm	45 kHz	M42 x 1	LA-GC-02K05B-00-R
Linea GigE 4k	4096 x 2	7.04 x 7.04 μm	45 kHz	M42 x 1	LA-GC-04K05B-00-R

Accessories	Order Number
M42 x 1 to F-mount adapter for 12mm BFD lens, heavy duty with clip	<a href="#">AC-LA-00115-xx-R</a>
M42 x 1 to C-mount adapter for 12 mm BFD lens	<a href="#">AC-LC-00001-xx-R</a>
HD15 GPIO Breakout Cable Assembly	<a href="#">AC-CA-00002-xx-R</a>
Linea Heatsink	AC-MS-00108-xx-R
For a list of accessories go to <a href="http://www.teledynedalsa.com/imaging/products/cameras/accessories/">http://www.teledynedalsa.com/imaging/products/cameras/accessories/</a>	
Optical filters are available from <a href="http://www.midwestopticalsystems.com/">http://www.midwestopticalsystems.com/</a>	

Teledyne DALSA Software Platform	
<b>Sapera LT version 8.12</b> and later includes the Sapera Network Imaging Package and GigE Vision Imaging Driver.	Available for download
<b>GigE Vision Turbo Drive Technology Module</b> — improved proprietary package allows the Linea GigE to sustain higher data transfers to the host system. Contact Teledyne DALSA Sales for additional information.	<a href="http://www.teledynedalsa.com/imaging/support/downloads/sdks/">http://www.teledynedalsa.com/imaging/support/downloads/sdks/</a>
Sapera provides everything needed to develop imaging applications.	
New or alternative Linea GigE Firmware Designs	Via web download
Sapera Processing Imaging Development Library (available for Windows or Linux - sold separately):	Contact Teledyne DALSA Sales

Third Party GigE Vision Software Platform Requirements	
Support of GenICam GenApi version 2.3	General acquisition and control. File access: firmware, FFC, configuration data, upload & download.
Support of GenICam XML schema version 1.1	
Support of GigE Vision 1.2	Includes end-of-line Metadata
GenICam™ support — XML camera description file	Embedded within Linea GigE

# GigE Vision Sopera Application Description



Linea GigE cameras are 100% compliant with the GigE Vision 1.2 specification which defines the communication interface protocol used by any GigE Vision device. The device description and capabilities are contained in an XML file. For more information see: <http://www.machinevisiononline.org/public/articles/index.cfm?cat=167>



Linea GigE cameras implement a superset of the GeniCam™ specification which defines device capabilities. This description takes the form of an XML device description file respecting the syntax defined by the GenApi module of the GeniCam™ specification. For more information see [www.genicam.org](http://www.genicam.org).

The Teledyne DALSA GigE Vision Module provides a license free development platform for Teledyne DALSA GigE hardware or Sopera vision applications. Additionally supported are Sopera GigE Vision applications for third party hardware with the purchase of a GigE Vision Module license, or the Sopera processing SDK with a valid license.

The GigE Vision Compliant XML device description file is embedded within Linea GigE firmware allowing GigE Vision Compliant applications access to camera capabilities and controls immediately after connection.

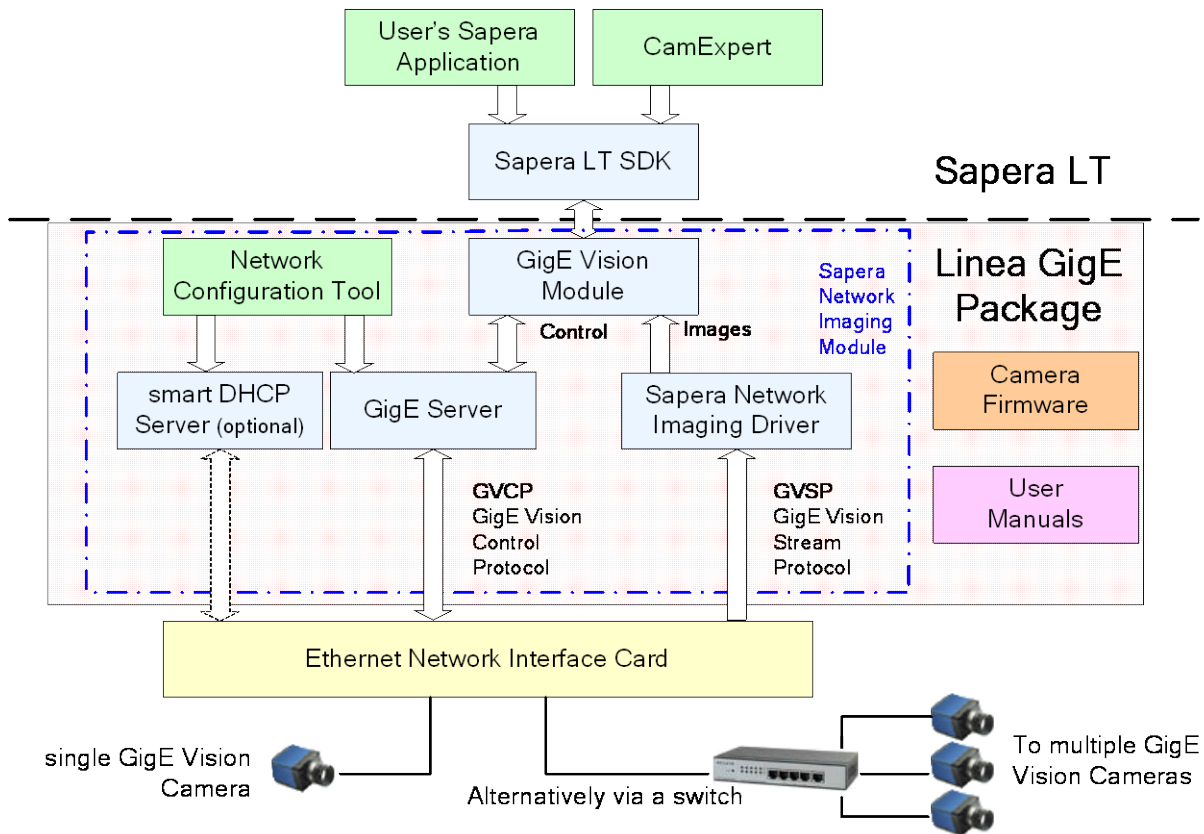

# Camera Specifications Overview

Camera Controls	
Synchronization Modes	Free running, External triggered, Software trigger through Ethernet
Exposure Modes	Programmable in increments of 1 $\mu$ s minimum (in $\mu$ s) is model specific maximum is 3 milliseconds Pulse controlled via Trigger pulse width.
Trigger Inputs (used as Line or Frame triggers)	RS422, and 3.3V to 24V typical Debounce range from 0 up to 255 $\mu$ s Frame Triggers have a programmable delay up to 2,000,000 $\mu$ s for 128 objects max.
Strobe Outputs	Aligned to the start of exposure with a programmable delay, duration and polarity (using "start of exposure on output line source" feature)
Features	
Flat Field Correction	1 Factory FFC plus 4 User Defined FFC
Binning	Digitally based: Horizontal & Vertical (2 pixel)
Gain	1x to 10x
Counter and Timer	2 Counters, and 2 Timers. User programmable, acquisition independent, with event generation.
Timestamp	1 $\mu$ s internal timer (external signaling planned with a future release)
Metadata Support	End-of-Line Metadata
Test image	Internal generator with choice of static patterns
User settings	Select factory default or either of two user camera configurations
Onboard Memory	
Minimum Reserved Data Buffer	200 MB
Reserved Packet Resend Buffer	24 MB default (user defined feature)
Reserved Private User Buffer	4 kB
Total Memory	256 MB
Back Focal Distance	
M42 x 1 mount	12 mm
M42 to Nikon F bayonet adapter	46.5 mm (34.5 mm for the F mount adapter plus 12 mm for the camera body)
M42 to C-Mount adapter	17.52 mm (5.52 mm for the C mount adapter plus 12 mm for the camera body)
Mechanical Interface	
Camera Size	2k/4k: 62(H) x 62(W) x 46.64(L) in mm For complete dimensions, refer to the Mechanical Specifications section.
Mass	2k/4k: < 280g (no lens)
Power connector	via HD15 GPIO connector
Ethernet connector	RJ45
Electrical Interface	
Input Voltage	+12 to +24 Volts DC (+20%/- 10%)
Power Dissipation	<7.5 W (2K/4K)
Operating Temperature	0 to 65°C at front plate
Relative Humidity	15% to 85% non-condensing (storage and operating)
Output Data Configuration	Gigabit Ethernet with PAUSE Frame support (as per IEEE 802.3x)
Data and Control	GigE Vision compliant

## Environmental Specifications

Environmental Specifications	Performance
Storage temperature range	-20 °C to +80 °C
Humidity (storage and operation)	15% to 85% relative, non-condensing
MTBF (mean time between failures)	> 100,000 hours, typical field operation

## Compliance, EMI Certifications

Compliance Directives	Standards ID	Overview
CE	EN55032 (2012)	Electromagnetic compatibility of multimedia equipment — Emission requirements
	EN55011 (2009) with A1(2010)	Industrial, scientific and medical equipment — Radio-frequency disturbance characteristics — Limits and methods of measurement
	EN 61326-1 (2013)	Electrical equipment for measurement, control and laboratory use — EMC requirements — Part 1: General requirements
	EN 55024 (2010)	Information technology equipment — Immunity characteristics — Limits and methods of measurement
	CISPR 11	Industrial, scientific and medical equipment — Radio-frequency disturbance characteristics — Limits and methods of measurement
	CISPR 32	Electromagnetic compatibility of multimedia equipment - Emission requirements
FCC	Part 15, class A	
RoHS	Compliance as per European directive 2004/105/EC	
For an image of the Linea GigE certificate see "EC & FCC Declarations of Conformity" on page 121		

## Flash Memory Size

Camera	Flash Memory Size
LA-GC-02K08A	512 MByte
LA-GC-04K08A	512 MByte

---

## Sensor Performance:

The sensor description below provides a specification table and response graphics. The graph describes the sensor response to different wavelengths of light (excluding lens and light source characteristics). Visible light spans wavelengths between about 390 - 780 nanometers. Wavelengths below 390 nm are termed ultra-violet while those above 780 nm are termed infra-red.

## Sensor Specifications

Item / Feature	Specification
Camera Models	LA-GC-02K05B-00-R (2048), LA-GC-04K05B-00-R (4096)
Sensor Used	High speed CMOS line scan
Minimum Line Rate (internal acquisition)	100 Hz
Maximum Line Rate (internal acquisition)	2k/4k: 45kHz
Maximum Line Rate Output	System dependent on the GigE network
Exposure Control	4 $\mu$ s to 3 ms
Internal Trigger to Start of Exposure	$\sim$ 0.24 $\mu$ s minimum (programmable exposure mode)
External Trigger to Start of Exposure	$\sim$ 0.30 $\mu$ s minimum (programmable exposure mode) $\sim$ 12.75 $\mu$ s (pulse width controlled exposure mode)
Horizontal Line Time	12.5 $\mu$ s
Readout Time	20.1 $\mu$ s
Pixel Size	7.04 $\mu$ m x 7.04 $\mu$ m
Pixel Format	User selectable 8-bit
Sensor Gain Range	Default Gain value = 1.0, User selectable 1x to 10x
Output Dynamic Range	>60 db (nominal gain)
Random Noise	< 0.17 DN rms (FFC enabled)
DC Offset	< 1DN — 8-bit (FFC enabled)
PRNU	< 1.5% @ 50% Saturation
FPN	< 0.35 DN
SEE	11.1 nJ / cm <sup>2</sup> (red), 13.3 nJ / cm <sup>2</sup> (green), 12.8 nJ / cm <sup>2</sup> (blue)
NEE	7.55 pJ / cm <sup>2</sup> (red), 9.00 pJ / cm <sup>2</sup> (green), 8.77 pJ / cm <sup>2</sup> (blue),
Anti-blooming	> 100 x Saturation
Integral non-linearity	1.5 % DN

## Test Conditions

- Values measured using 8-bit, 1x gain
- 10 kHz line rate
- Light source: broadband, quartz halogen, 3250 K with 700 nm IR cut-off filter
- Front plate temperature: 45° C

## Spectral Responsivity:

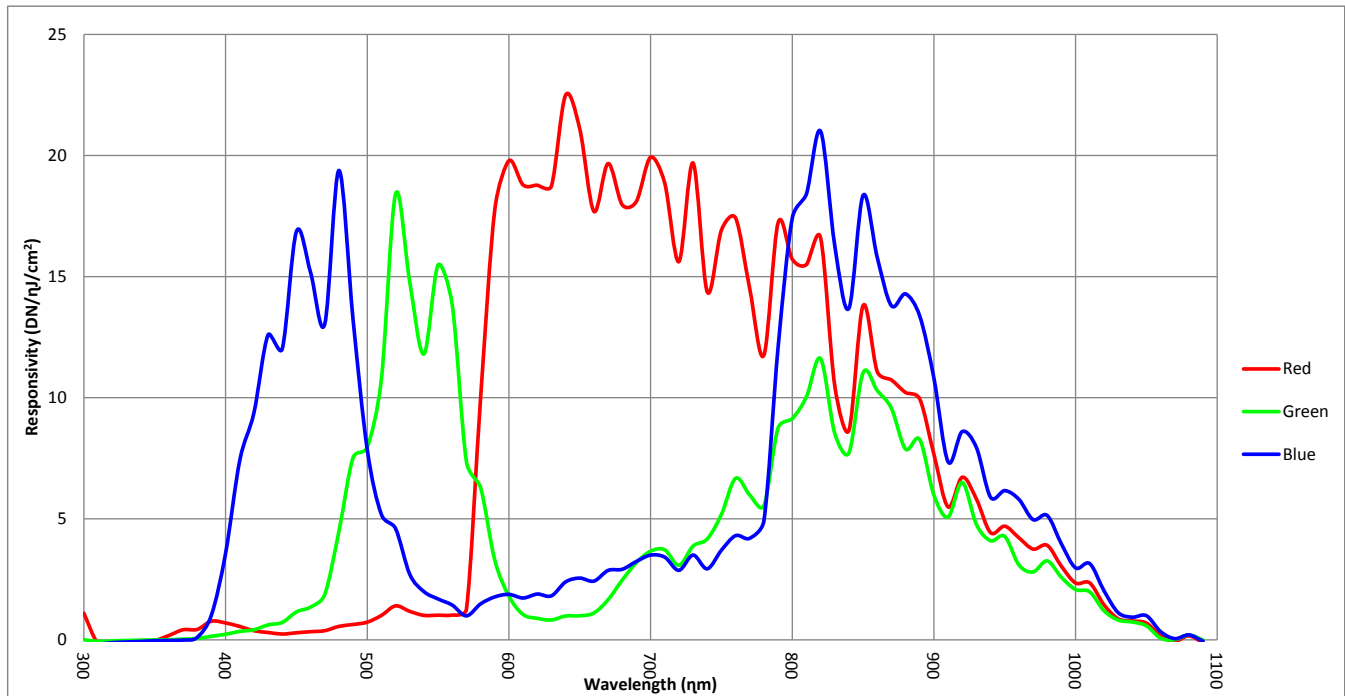

Typical Spectral Responsivity (No white balance, 8 bit, 1x gain)

## Spatial Correction and Bilinear Sensor Design

The bilinear color camera is based on Teledyne DALSA's bilinear CMOS sensor and designed such that the first line of this two line sensor has red (R) and blue (B) alternating pixels, while the second line has all green (G) pixels. The sensor has a 100% fill factor with zero gap between the two lines, which minimizes any artifact due to spatial correction. The G channel can be used as a monochrome output.

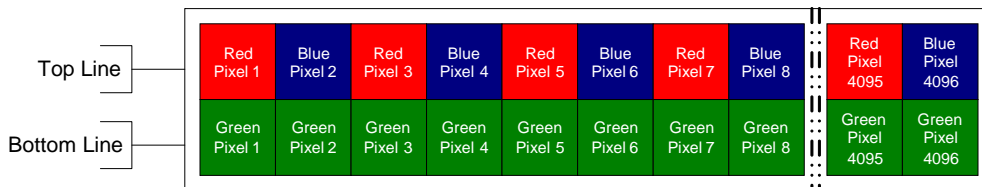

Note: The interpolation procedure does not work on the first and last pixels. As a result, the number of effective full color (RGB) pixels is reduced by 2 to 4094 pixels.

There is no spacing between the sensor lines. When the image passes the two lines of pixels, the red/blue and green components for the same image location are captured at a different time as dictated by the line spacing. The camera automatically corrects for the line spacing to ensure that the red/blue and green components of the image pixel are all aligned when output. However, this is only correct when the object pixel size is square; i.e., the distance moved by the object for one EXSYNC period is equal to the width of the object pixel. In some applications it may not be possible to achieve a 'square' object pixel as fine adjustment of the lens magnification and/or the distance

moved for each EXSYNC period is not possible. This scenario may be especially apparent when trying to integrate the camera into an existing system.

When it is not possible to generate a square object pixel, color artifacts will occur in the scan direction and is particularly noticeable at sharp edge transitions. The size of the edge artifact is proportional to how far the pixel is from square. To correct for this, the camera has a feature, Line Spatial Correction, which allows fine adjustment of the compensation mechanism the camera uses to correct for the line spacing.

The default setting for this feature is 1, which is set for square object pixels. The setting can be adjusted from 0 to 3 to compensate for rectangular pixels—whether they are too long or too short.

The following examples of image artifacts show black to white image transitions and the associated corrected image after applying a specific spatial setting.

**Example 1. Target speed adjusted for square pixels**



Line Spatial Correction = 0. This is the default condition.

**Example 2. Target running slower than example 1, same EXSYNC (trigger) frequency**

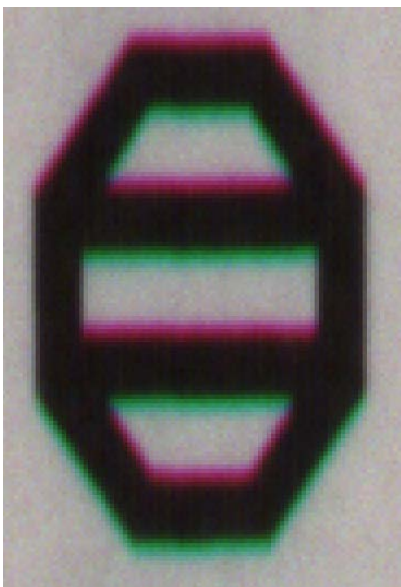

Line Spatial Correction = 2



Line Spatial Correction = 3



**Example 3. Target running faster than example 1, same EXSYNC (trigger) frequency**

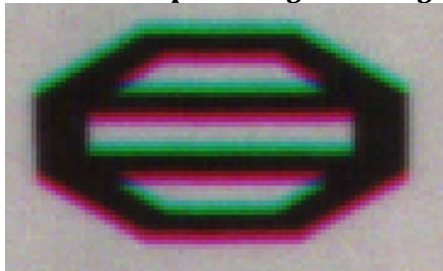

Line Spatial Correction = 3



Line Spatial Correction = 1.73

**Parallax Correction**

When the camera is not perpendicular to the object surface it will exhibit color. The parallax distortion increases when imaging at steep angles relative to the cameras imaging plain. This is an optical effect caused by the line spacing of the three individual colors. This spacing results in a different magnification for each line at high angles. As shown in the figure below, there is color distortion at the extremes ends of the image but at the center of the image the color distortion does not show up.

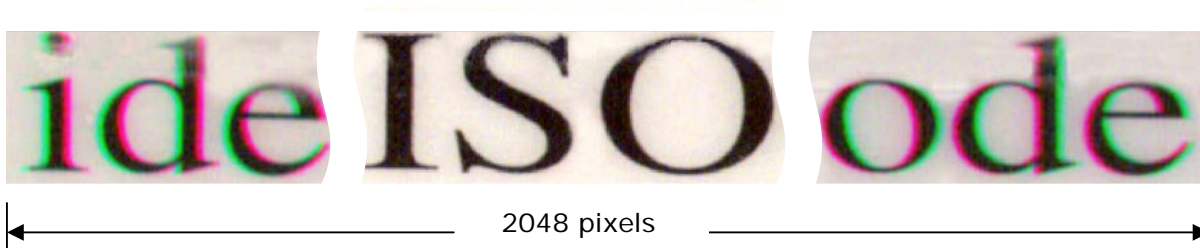

Figure 1: Image with Horizontal Color Alignment Issues

Using the cameras Parallax Correction feature, the optical magnification for each line is adjusted such that colors can be lined up at the extreme ends of the image without affecting the center. Using the feature Image Distortion Correction Mode this feature can be turned on. Using the feature Image Distortion Correction Line Selector the user can select red and green to correct the distortion. Note. The red and green lines are adjusted to align with the center blue line. Image Distortion Parallax Correction Pixel Stretch is used to add the amount of correction needed to the image. The value entered here must be between 0 and 3 (decimal values are accepted).

Image Distortion Correction Mode	Off
Image Distortion Correction Algorithm	ParallaxCorrection
Image Distortion Correction Line Selector	Red
Image Distortion Parallax Correction Pixel Stretch	0

Figure 2: CamExpert Parallax Correction Controls





Figure 3: Figure 4 Corrected Image

The figure above is the same image corrected using the parallax correction. In this example the value of 3 was used to correct the image.

### Camera Direction

Selectable camera direction accommodates an object direction change on a web and allows you to mount the camera “upside down”.

Note: The example here assumes the use of a lens (which inverts the image).

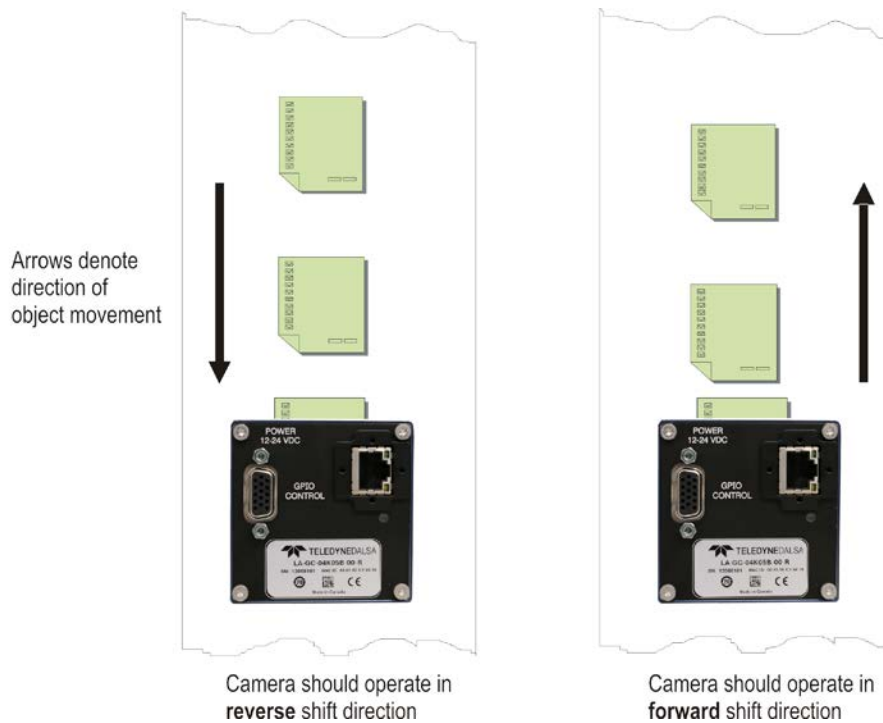

Figure 5: Object Movement and Camera Direction Example, with a Lens

# Connecting the Linea Color GigE Camera

---

## GigE Network Adapter Overview

If the computer to be used with the Linea GigE camera does not have a Gigabit network adapter or second built in Gigabit NIC, a Gigabit Network Interface adapter card (NIC) needs to be installed. Typically under Windows, the Gigabit NIC is recognized automatically when Windows boots.

With any high performance Gigabit NIC adapter, review the NIC documentation concerning any special driver required for your specific operating system. When adding a NIC adapter to a computer, Teledyne DALSA engineering has seen cases where a PCI Express bus Gigabit NIC has better overall performance than the same NIC hardware in PCI bus format.

## PAUSE Frame Support

The Linea GigE supports the Gigabit Ethernet PAUSE Frame feature as per IEEE 802.3x. PAUSE Frame is the Ethernet flow control mechanism that temporarily stops data transmission on the network. The PAUSE Frame feature can help a NIC that doesn't have enough buffering to handle full-speed reception. This requires that the flow control option in the NIC property settings and the Ethernet switch settings must be enabled.

Note that this problem is not as common with advances in computer bus speeds and memory sizes. PAUSE Frame support is typically required to manage network traffic within an Ethernet switch when multiple cameras are simultaneously used. Using PAUSE Frame will require the user to test various values of Jumbo Frames, to determine the best data throughput. Therefore the downside to managed network traffic is that the Pause Frame control will reduce the absolute maximum transfer bandwidth possible on the network.

---

## Connect the Linea Color GigE Camera

Connecting a Linea GigE to a network system is independent of whether the Teledyne DALSA Sapera LT package or a third party GigE Vision development package is used.

- Before connecting power to the camera, test all power supplies. Power supplies must meet the requirements defined in section "Input Signals Electrical " on page 116. Apply power to the camera.
- Connect Linea GigE to the host computer GigE network adapter or to the Ethernet switch via a CAT5e or CAT6 Ethernet cable. **Note:** cable should not be less than 1 meter (3 feet) long or more than 100 meters (328 feet) long.
- Once communication with the host computer is started the automatic IP configuration sequence will assign an LLA IP address as described in section "Linea GigE IP Configuration Sequence" on page 19, or a DHCP IP address if a DHCP server is present on your network.
- Check the diagnostic LED which will be initially red then switch to flashing blue while waiting for IP configuration. See "Camera Status LED " on page 18 for Linea GigE LED display descriptions.

- The factory defaults for Linea GigE is Persistent IP disabled and DHCP enabled with LLA always enabled as per the GigE Vision specification. For additional information see "IP Configuration Mode Details" on page 108. See the next section "Connectors" on page 17 for an overview of the interface.

## Connectors

The Linea GigE has two connectors:

- A single **RJ45 Ethernet** connector for control and video data transmitted to/from the host computer Gigabit NIC. See "Ruggedized RJ45 Ethernet Cables" on page 131 for secure cables.
- A **HD15** connector for camera power, plus trigger, strobe and general I/O signals. Teledyne DALSA provides an optional breakout cable See Mating GPIO Cable Assembly. See "HD15 type Connector Details" on page 114 for connector pin out specifications.

The following figure of the Linea GigE back end shows connector and LED locations. See "Mechanical Specifications" on page 112 for details on the connectors and camera mounting dimensions.

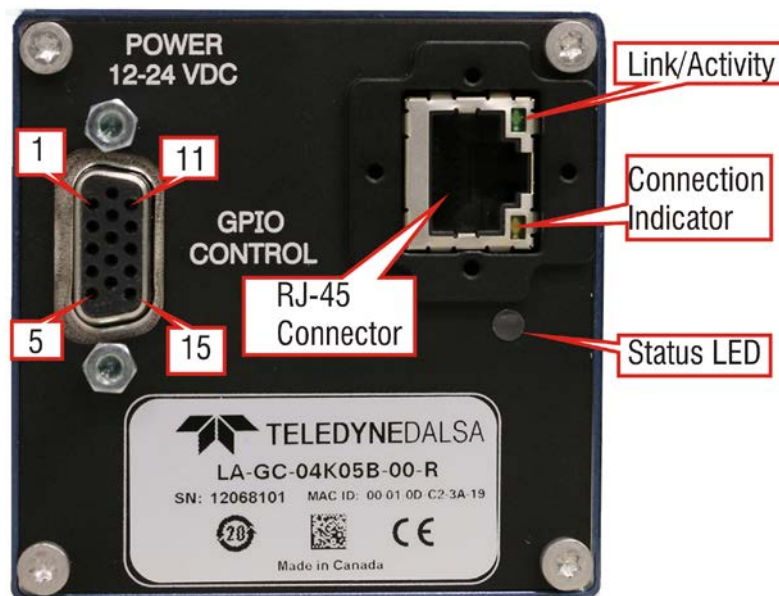

*Linea GigE – Rear View*

## LED Indicators

The Linea GigE has one multicolor LED to provide a simple visible indication of camera state and the RJ45 Ethernet connector has two LEDs for network status conditions. These are described below.

### Network Status Indicators

The Linea GigE RJ45 Ethernet connector has two LEDs which display standardized information, defined as follows:

Ethernet Connector LEDs	Color	Description
<b>Left LED</b> (Connection indicator)	Amber	Connected to a network
	Off	Not Connected to a network
<b>Right LED</b> (Link/Activity indicator)	Green	Blinking – There is activity on the port
	Off	No data is currently being transferred

### Camera Status LED Indicator

The camera is equipped with one LED to display the operational status of the camera. When more than one condition is active, the LED color indicates the condition with the highest priority (such as an acquisition in progress has more priority than a valid IP address assignment).

Once the Linea GigE is connected to a network, the Status LED will turn to steady blue when the IP address is assigned. Only at this time will it be possible by the GigE Server or any application to communicate with the camera. The following table summarizes the LED states and corresponding camera status.

LED State	Definition
LED is off	No power to the camera
Steady Red	Initial state on power up before flashing. Remains as steady Red only if there is a fatal error. Camera is not initialized **
Flashing Red	Initialization sequence in progress ** Wait a few minutes for the camera to reboot itself.
Steady Red + Flashing Blue	Fatal Error. If the camera does not reboot itself contact Technical Support.
Slow Flashing Blue	Ethernet cable disconnected. The camera continuously attempts to assign itself an IP address.
Fast Flashing Blue	File Access Feature is transferring data such as a firmware update or FCC transfer, etc.
Steady Blue	IP address assigned; no application connected to the camera
Steady Green	Application connected
Flashing Green	Acquisition in progress. Flashing occurs on frame acquisition but does not exceed a rate of 100ms for faster frame rates.



**Note:** Even if the Linea GigE has obtained an IP address, it might be on a different subnet than the NIC it is attached to. Therefore, if the Linea GigE LED is blue but an application cannot see it, this indicates a network configuration problem. See the troubleshooting section in this manual.

## ***LED States on Power Up***

The following LED sequence occurs when the Linea GigE is powered up connected to a network with installed GigE Vision software.

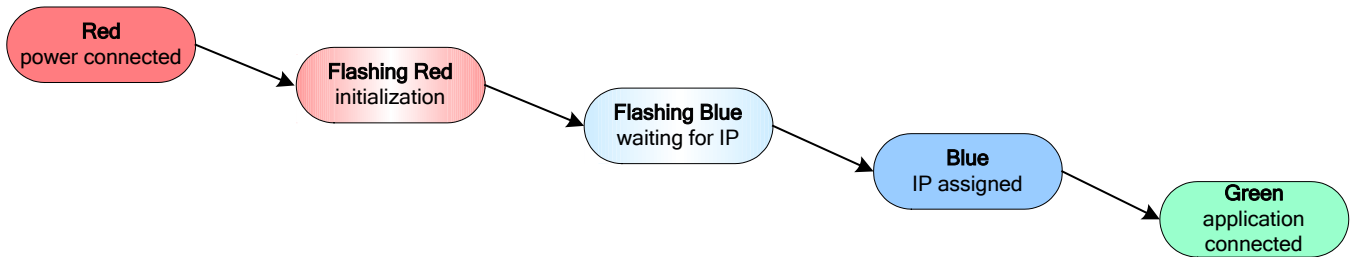

## **Linea GigE IP Configuration Sequence**

The IP (Internet Protocol) Configuration sequence to assign an IP address is executed automatically on camera power-up or when connected to a network. As a GigE Vision compliant device, Linea GigE attempts to assign an IP address as follows.

For any GigE Vision device, the IP configuration protocol sequence is:

- Persistent IP (if enabled)
- DHCP (if a DHCP server is present such as the Teledyne DALSA Smart DHCP server)
- Link-Local Address (always enabled)

The factory defaults for Linea GigE is Persistent IP disabled and DHCP enabled with LLA always enabled as per the GigE Vision specification. For additional information see "IP Configuration Mode Details" on page 108.

### ***Supported Network Configurations***

The Linea GigE obtains an IP address using the Link Local Address (LLA) or DHCP, by default. A LLA IP address is obtained typically in a few seconds with Microsoft Windows Vista/7/8. If required, a persistent IP address can be assigned (see "Running the Network Configuration Tool" on page 26).

Preferably, a DHCP server is present on the network, where the Linea GigE issues a DHCP request for an IP address. The DHCP server then provides the IP address. The Teledyne DALSA Network Configuration tool, installed with the Teledyne DALSA Network Imaging Package, provides a DHCP server which is easily enabled on the NIC used with the Linea GigE (refer to the Teledyne DALSA Network Imaging Package user's manual).

The LLA method, if used, automatically assigns the camera with a randomly chosen address on the 169.254.xxx.xxx subnet. After an address is chosen, the link-local process sends an ARP query with that IP onto the network to see if it is already in use. If there is no response, the IP is assigned to the device, otherwise another IP is selected, and the ARP is repeated. Note that LLA is unable to forward packets across routers.

---

## Preventing Operational Faults due to ESD

Linea GigE camera installations which do not protect against ESD (electrostatic discharge) may exhibit operational faults. Problems such as random packet loss, random camera resets, and random loss of Ethernet connections, may all be solved by proper ESD management.

The Linea GigE camera when used with a simple power supply and Ethernet cable, is not properly connected to earth ground and therefore is susceptible to ESD caused problems. An Ethernet cable has no ground connection and a power supply's 0 volt return line is not necessarily connected to earth ground.

The following methods, either individually or together, will reduce or prevent ESD problems:

- Method 1: Use a shielded power supply. The camera case is now properly connected to earth ground and can withstand high ESD events.
- Method 2: Use a shielded Ethernet cable to provide a ground connection from the controlling computer, to the Linea GigE.
- Method 3: Mount the camera on a metallic platform with a good connection to earth ground.
- Method 4: Avoid running the Ethernet cable close to or parallel to AC power lines.

# Using Linea GigE with the Sopera API

A Linea GigE camera installation with the Teledyne DALSA Sopera API generally follows the sequence described below. Detailed installation instructions follow this overview.

---

## Network and Computer Overview

- Linea GigE needs to connect to a computer with a **GigE network adapter**, either built in on the computer motherboard or installed as a third party PCI adapter. See the previous section Connecting the Linea Color GigE Camera.
- **Laptop computers** with built in **GigE network adapters** may still not be able to stream full line rates from Linea GigE, especially when on battery power. Thorough testing is required with any laptop computer to determine the maximum frame rate possible (refer to the Teledyne DALSA Network Imaging Package user's manual).
- Linea GigE also can connect through a **Gigabit Ethernet switch**. When using VLAN groups, the Linea GigE and controlling computer must be in the same group (refer to the Teledyne DALSA Network Imaging Package user's manual).
- If Linea GigE is to be used in a **Sopera development environment**, Sopera LT 7.50 needs to be installed, either before or after the **GigE Vision Module** software package.
- If using Sopera LT 8.0 or later, all GigE Vision support is automatically installed.
- For maximum sustained data transfers to host, install the Teledyne DALSA **GigE Vision Turbo Drive Technology** module even if using Sopera LT 8.0.
- If Linea GigE will be used in a **third party GigE Vision Compliant environment**, Sopera or Sopera runtime is not required and you need to follow the installation instructions of the third party package.
- The **Windows Firewall** exceptions feature is automatically configured to allow the Sopera GigE Server to pass through the firewall.
- Computers with **VPN software** (virtual private network) may need to have the VPN driver disabled in the NIC properties. This would be required only on the NIC used with the Linea GigE. Testing by the user is required.
- Once a Linea GigE is connected, look at the small camera icon added to the Windows tray (next to the clock). Ensure the camera has been found (right click the icon and select Status) Note that in Windows 7, the icon remains hidden until a camera is connected.
- A new Linea GigE camera may require a firmware update. The [File Selector](#) feature is used to select a firmware file. See the CamExpert procedure "File Access via the CamExpert Tool" on page 106 for additional information.
- Use CamExpert (installed either with Sopera or Sopera runtime) to test the installation of the Linea GigE camera. Set the Linea GigE to internal test pattern. See "

## Metadata Format

- The Linea GigE metadata is formatted as follows:

QWORD #	Bits	Feature Name	Description
QWORD 1	63:48	Gain - Digital All	The gain-digital all as an amplification factor applied to the image.
	47:40	Line Status All	The current status of all available line signals in a single bitfield. The order is Line1, Line2, Line3, ...
	39:36	Flat Field Correction Current Active Set	The index of the current set of Flat Field coefficients being used.
	35:32	Cycling Preset Current Active Set	The index of the currently active cycling preset.
	31:0	Exposure Time	The exposure time, where 1 DN = 10 ns.
QWORD 2	63:56	<i>Unused</i>	
	55:32	Line Trigger Counter	Counts the total # of line triggers received during the current frame
	31:28	<i>Unused</i>	
	27:25	Counter2 Active	The status of counter # where: 0=Idle 1=Trigger Wait 2=Active 3=Completed 4=Overflow 5=Wait
	24:22	Counter1 Active	
	21:19	Timer2 Active	The status of timer # where: 0=Idle 1=Trigger Wait 2=Active 3=Completed 5=Delaying
	18:16	Timer1 Active	
15:0	Line Counter	Specifies the position of a line within the current frame.	
QWORD 3	63:0	Timestamp	The value of the timestamp counter.
QWORD 4	63:32	Timer1 Value	The value of timer 1.
	31:0	Counter1 Value	The value of counter 1.
QWORD 5	63:32	Timer2 Value	The value of timer 2.
	31:0	Counter2 Value	The value of counter 2.
QWORD 6	63:32	Camera ID	The identifier of the device. This may be user-defined, but defaults to the serial number.
	31:0	FrameCounter Value	Increments at the start of each frame.



- "Internal Test Image Generator" on page 83.
- Set up the other components of the imaging system such as light sources, camera mounts, optics, encoders, trigger sources, etc. Test with CamExpert.

---

# Installation



**Note:** to install Sopera LT and the GigE Vision package, logon to the workstation as an administrator or with an account that has administrator privileges.

When Linea GigE is used in a **Sopera development environment**, **Sopera LT 8.12** needs to be installed, either before or after the camera software package (GigE Vision and Network Imaging package). If using **Sopera LT 8.12** or later, all GigE Vision support for cameras is automatically installed.

If no Sopera development is required, then the Sopera LT SDK is not needed to control the Linea GigE camera. Sopera runtime with CamExpert provides everything to control the camera.

## Procedure

- Download and install Sopera 8.0 which automatically provides GigE Vision support.
- Contact Teledyne DALSA concerning the GigE Vision package supporting TurboDrive™ technology.
- Optional: If the Teledyne DALSA Sopera LT SDK package is not used, click to install the Linea GigE firmware and user manuals only. Follow the on screen prompts.
- Connect the Linea GigE camera to an available free Gigabit NIC.

Refer to Sopera LT User's Manual concerning application development with Sopera.





**Note:** The Teledyne DALSA Sopera CamExpert tool (used throughout this manual to describe Linea GigE Vision features) is installed with either the Sopera LT runtime or the Sopera LT development package. If Sopera application development is required, install Sopera (7.50 or later for all firmware support) as described in the previous section.

## Camera Firmware Updates

The user can upload new firmware, downloaded from Teledyne DALSA support, using the [File Access Control](#) features via Sopera CamExpert.

## GigE Server Verification

After a successful Sapera GigE Vision package installation, the GigE Server icon is visible in the desktop taskbar tray area (note that in Windows 7 the icon remains hidden until a camera is connected). After connecting a camera (see following section), allow a few seconds for the GigE Server status to update. The Linea GigE camera must be on the same subnet as the NIC to be recognized by the GigE Server.

	Device Available	Device IP Error	Device Not Available
<b>GigE Server Tray Icon:</b>			
	The normal GigE server tray icon when the camera device is found. It will take a few seconds for the GigE Server to refresh its state after the camera has obtained an IP address.	The GigE server tray icon shows a warning when a device is connected but there is some type of IP error.	A red X will remain over the GigE server tray icon when the camera device is not found. This indicates a major network issue. <b>Or in the simplest case</b> , there is no camera connected.

If you place your mouse cursor on this icon, the GigE Server will display the number of GigE Vision devices found by your PC. Right click the icon and select status to view information about those devices. See "Running the Network Configuration Tool" on page 26 and "Troubleshooting" on page 132 for more information.

## GigE Server Status

Once the Linea GigE is assigned an IP address (its Status LED is steady blue) the GigE server tray icon will not have a red X through it, indicating that the device was found. It might take a few seconds for the GigE Server to refresh its state after the camera has obtained an IP address.



Right-click the GigE Server tray icon to open the following menu.

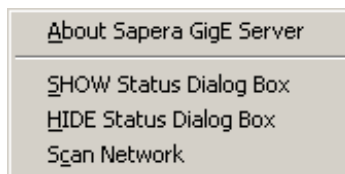

Click on Show Status to open a window listing all devices connected to the host system. Each GigE device is listed by name along with important information such as the assigned IP address and device MAC address. The screen shot below shows a connected Linea GigE with no networking problems.

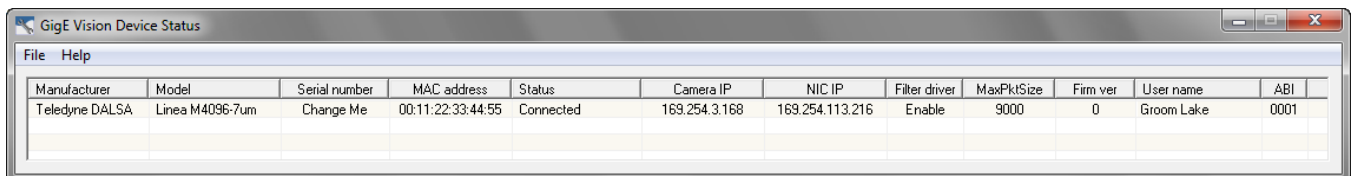

Manufacturer	Model	Serial number	MAC address	Status	Camera IP	NIC IP	Filter driver	MaxPktSize	Firm ver	User name	ABI
Teledyne DALSA	Linea M4096-7um	Change Me	00:11:22:33:44:55	Connected	169.254.3.168	169.254.113.216	Enable	9000	0	Groom Lake	0001

In the event that the device is physically connected, but the Sapera GigE Server icon is indicating that the connected device is not recognized, click Scan Network to restart the discovery process. Note that the GigE server periodically scans the network automatically to refresh its state. See "Troubleshooting" on page 132 for network problems.

## Optimizing the Network Adapter used with Linea GigE

Most Gigabit network interface controllers (NIC) allow user modifications to parameters such as Adapter Buffers and Jumbo Frames. The optimal settings will be system dependent. These should be optimized for use with the Linea GigE during the installation. Refer to the **Teledyne DALSA Network Imaging package manual** for optimization information.

## Running the Network Configuration Tool

The Network Configuration tool provides information and parameter adjustments for network adapters installed in the system and any connected GigE Vision camera without use of any Windows Control Panel application. This tool allows you to:

- Activate the Network Imaging driver use for image acquisition on any NIC or disable the imaging driver for any NIC not used with a GigE Vision camera.
- Configure the NIC as a DHCP server for connected GigE Vision camera.
- Change the Auto Discovery Interval from the default of 15 seconds.
- Configure the NIC and camera IP settings.
- Assign a User Defined name to a connected camera.
- Assign a Persistent IP address to a camera instead of the default DHCP/LLA assigned address.



**Important:** Changes made with this tool may update Linea GigE parameters stored in flash memory. Do not remove power from the camera for a minimum 10 seconds.

Refer to the **Teledyne DALSA Network Imaging Module** manual for more detailed information on using this tool. As shown below, the Network Configuration tool can quickly verify and modify certain network configuration items of the imaging system.

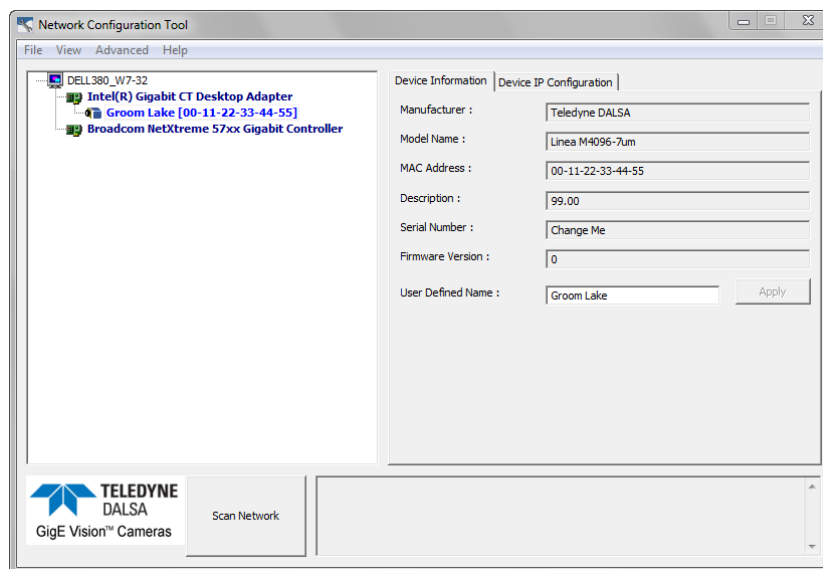

Run the tool from the Windows Start menu: **Start•Programs•Teledyne DALSA•Sapera Network Imaging Package•Dalsa Network Configuration Tool**. Verify the camera appears as a child of the NIC card it is connected to. By default the camera is identified by its serial number if no user defined name has been assigned.

---

## Quick Startup with CamExpert

When the Linea GigE camera is connected to a Gigabit network adapter on a host computer, testing the installation with CamExpert is a straightforward procedure.

- Start Sapera CamExpert by double clicking the desktop icon created during the Sapera installation.
- CamExpert will search for installed Sapera devices. In the Device list area on the left side, the connected Linea GigE camera is shown or will be listed in a few seconds after CamExpert completes the automatic device search (device discovery).
- Select the Linea GigE device by clicking on the camera user defined name. By default the camera is identified by its serial number. The Linea GigE status LED will turn green, indicating the CamExpert application is now connected.
- Camera defaults will set AcquisitionLineRate="10000" Hz, TriggerMode=Off, ExposureMode=Timed, and ExposureTime="9.71" microsecond.
- Click on the Grab button for live acquisition (the Linea GigE factory default is Internal Trigger mode with a vertical height parameter which defines the virtual image frame). See "Operational Reference" on page 30 for information on CamExpert parameters with the camera.
- If the Linea GigE has no lens, just select one of the internal test patterns available (*Image Format Controls – Test Image Selector*). The CamExpert feature selection and the grabbed pattern are shown below.
- Note that CamExpert cannot grab at high virtual frame rates due to it generating an interrupt for each virtual video frame. The Sapera Grab Demo tool is better suited for high frame rates.
- If the AcquisitionLineRate is reduced and/or frame buffer Height is increased, then you may need to increase the value for the GigE Vision Host Control feature "Image Timeout".
- Refer to the Teledyne DALSA Network Imaging package manual if error messages are shown in the Output Messages pane. Try increasing the value of the Linea GigE Interpacket Delay feature available from the GigE Vision Transport Layer Category group in CamExpert. An increase from default may correct errors with NIC interfaces that do not have adequate performance.

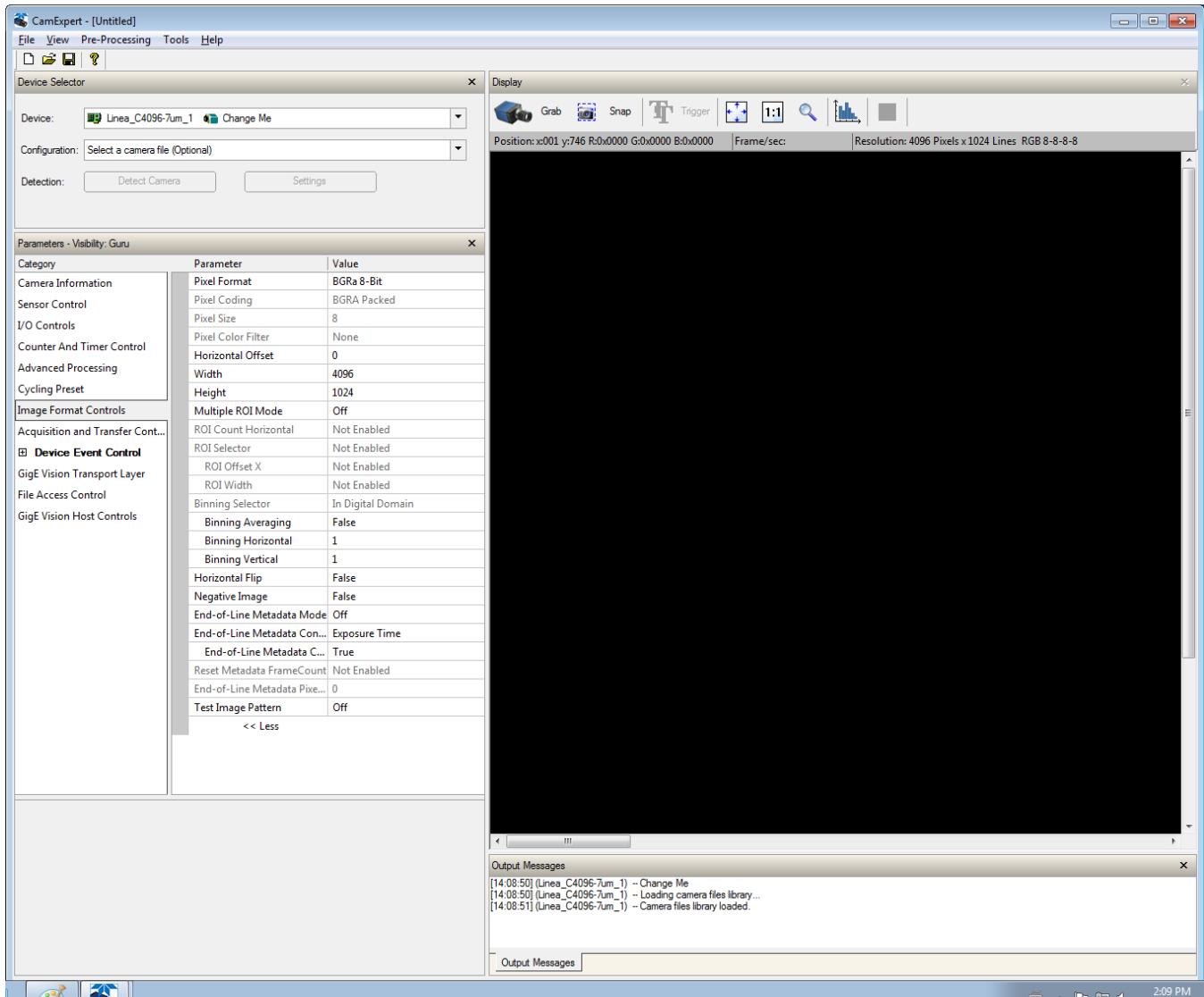

## About the User Defined Camera Name

The Linea GigE can be programmed with a user defined name to aid identifying multiple cameras connected to the network. For instance, on an inspection system with 4 cameras, the first camera might be labeled "top view", the second "left view", the third "right view" and the last one "bottom view". The factory default user name is the camera serial number for quick initial identification. Note that the factory programmed camera serial number and MAC address are not user changeable.

When using CamExpert, multiple Linea GigE cameras on the network are seen as different "Linea\_C4095-7um\_1" devices as an example. Non Teledyne DALSA cameras are labeled as "GigEVision Device". Click on a device user name to select it for control by CamExpert. An imaging application uses any one of these attributes to identify a camera: its IP address, MAC address, serial number or User Name. Some important considerations are listed below.

- Do not use the camera's IP address as identification (unless it is a persistent IP) since it can change with each power cycle.

- A MAC address is unique to a single camera; therefore the control application is limited to the vision system with that unique camera if it uses the camera's MAC address.
- The User Name can be freely programmed to clearly represent the camera usage. This scheme is recommended for an application to identify cameras. In this case, the vision system can be duplicated any number of times with cameras identified by their function, not their serial numbers or MAC address.



# Operational Reference

---

## Using CamExpert with Linea GigE Cameras

The Sapera CamExpert tool is the interfacing tool for GigE Vision cameras, and is supported by the Sapera library and hardware. When used with a Linea GigE camera, CamExpert allows a user to test most of the operating modes. Additionally CamExpert saves the Linea GigE user settings configuration to the camera or saves multiple configurations as individual camera parameter files on the host system (\*.ccf).

An important component of CamExpert is its live acquisition display window which allows immediate verification of timing or control parameters without the need to run a separate acquisition program.

Click on any parameter and a short description is displayed below the Category pane. The same context sensitive help is available by clicking on the  button then click on a camera configuration parameter. Click on the  button to open the help file for more descriptive information on CamExpert.



**Note:** The examples shown may not entirely reflect the features and parameters available from the camera model and camera mode used in your application.





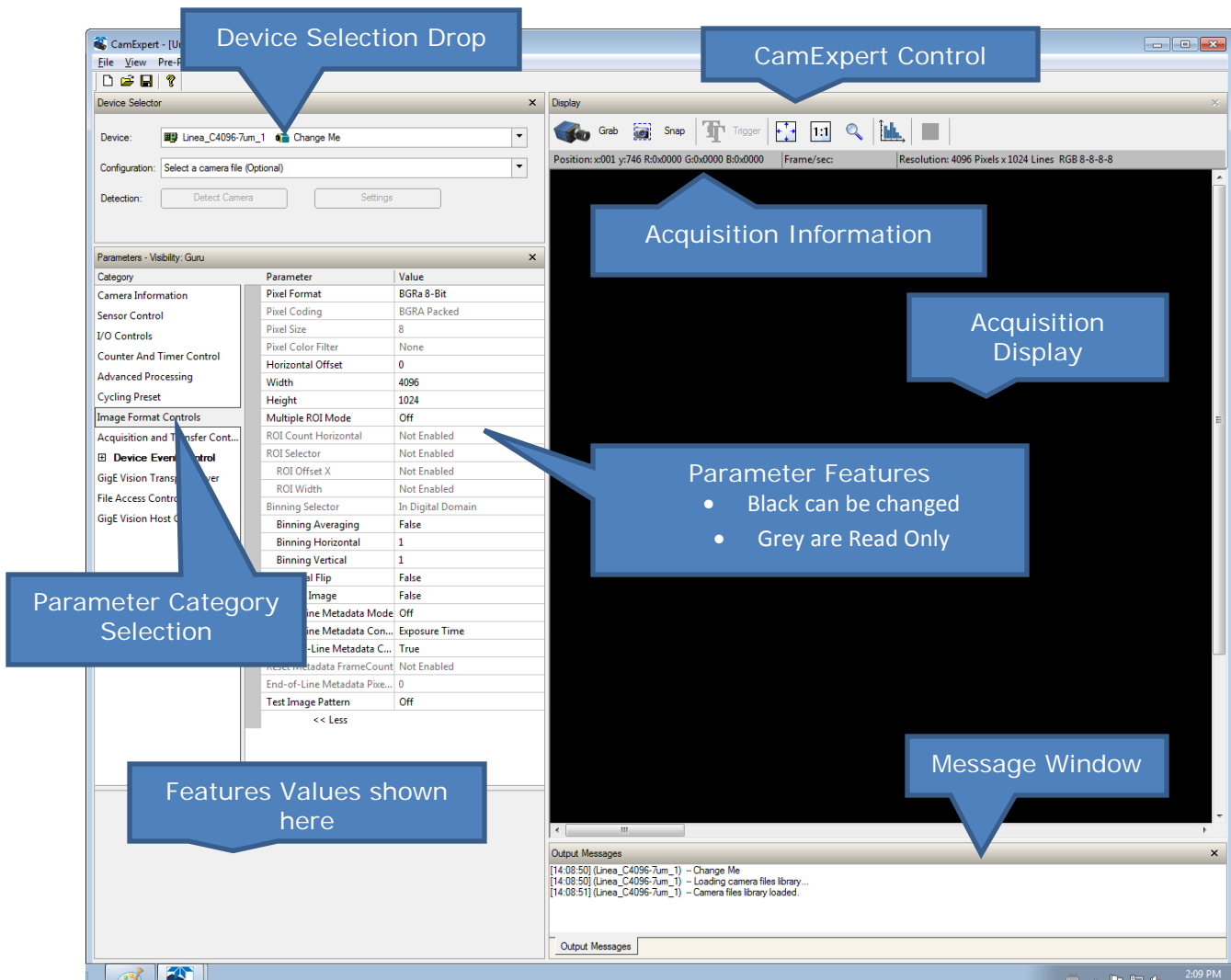

## CamExpert Panes

The various areas of the CamExpert tool are described in the figure below. GigE Vision device Categories and Parameter features are displayed as per the device's XML description file. The number of parameters shown is dependent on the View mode selected (Beginner, Expert, Guru – see description below).



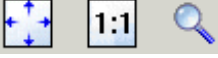

- **Device Selector pane:** View and select from any installed GigE Vision or Samera acquisition device. After a device is selected, CamExpert will only present parameters applicable to that device. Optionally select a camera file included with the Samera installation or saved by the user.
- **Parameters pane:** Allows viewing or changing all acquisition parameters supported by the acquisition device. CamExpert displays parameters only if those parameters are supported by the installed device. This avoids confusion by eliminating parameter choices when they do not apply to the hardware in use.
- **Display pane:** Provides a live or single frame acquisition display. Frame buffer parameters are shown in an information bar above the image window.
- **Control Buttons:** The Display pane includes CamExpert control buttons. These are:

		<b>Acquisition control button:</b> Click once to start live grab, click again to stop.
		<b>Single frame grab:</b> Click to acquire one frame from device.
		<b>Software trigger button:</b> With the I/O control parameters set to Trigger Enabled / Software Trigger type, click to send a single software trigger command.
		<b>CamExpert display controls:</b> (these do not modify the frame buffer data) Stretch (or shrink) image to fit, set image display to original size, or zoom the image to any size and ratio. This does not affect the acquisition.
		<b>Histogram / Profile tool:</b> Select to view a histogram or line/column profile during live acquisition.

- **Output pane:** Displays messages from CamExpert or the GigE Vision driver.

### ***CamExpert View Parameters Option***

All camera features have a Visibility attribute which defines its requirement or complexity. The states vary from Beginner (features required for basic operation of the device) to Guru (optional features required only for complex operations).

CamExpert presents camera features based on their visibility attribute. CamExpert provides quick Visibility level selection via controls below each Category Parameter list [ << Less More >> ]. The user can also choose the Visibility level from the *View · Parameters Options* menu.

### **Creating a Camera Configuration File in the Host**

- When using the Teledyne DALSA Sopera SDK – the CCF is created automatically via a save.
- When using a 3<sup>rd</sup> party SDK application, if that SDK supports **GenAPI 2.4**, then the process is automatic. Simply follow the 3<sup>rd</sup> party *Save Camera* method as instructed.
- If the SDK is based on **GenAPI 2.3** or lower, the user must call the command `DeviceFeaturePersistenceStart` before using the SDK *Save Camera* method and the command `DeviceFeaturePersistenceEnd` at the end of the save function.

# Camera Information Category

Camera information can be retrieved via a controlling application. Parameters such as camera model, firmware version, etc. are read to uniquely identify the connected Linea GigE device. These features are typically read-only. GigE Vision applications retrieve this information to identify the camera along with its characteristics.

The Camera Information Category groups information specific to the individual GigE Vision camera. In this category the number of features shown is identical whether the view is Beginner, Expert, or Guru. Features listed in the description table but tagged as *Invisible* are usually for Teledyne DALSA or third party software usage—not typically needed by end user applications.

## Camera Information Feature Descriptions

The following table describes these parameters along with their view attribute and in which device version the feature was introduced. Additionally the Device Version column will indicate which parameter is a member of the DALSA Features Naming Convention (denoted by **DFNC**), versus the GenICam Standard Features Naming Convention (SFNC not shown).

Category	Parameter	Value
Camera Information	Manufacturer Name	Teledyne DALSA
Sensor Control	Model Name	Linea C4096-7um
I/O Controls	Manufacturer part number	LA-GC-04K05B-00-R
Counter And Timer Control	Device Version	99.00
<input type="checkbox"/> <b>Advanced Processing</b>	Manufacturer Info	Standard Design
Color Processing	Firmware Version	3CA16.0000
Image Format Controls	<b>Serial Number</b>	12068238
Acquisition and Transfer Cont...	MAC Address	00:11:22:33:44:55
<input checked="" type="checkbox"/> <b>Device Event Control</b>	Device User ID	
GigE Vision Transport Layer	Power-up Configuration Selector	UserSet 1
File Access Control	Device Built-In Self Test	Press...
Production Features	Device Built-In Self Test Status	Passed
GigE Vision Host Controls	Device Built-In Self Test Status All	0
	Sensor Error Status	OK
	Device Reset	Press...
	Device Temperature Selector	Camera Temperature
	Device Temperature	40.0
	overheatedStatus	OK
	Power-up Configuration	Setting...

<< Less

Display Name	Feature & Values	Description	Device Version & View
Manufacturer Name	DeviceVendorName	Displays the device vendor name. (RO)	1.00 Beginner
Model Name	DeviceModelName	Displays the device model name. (RO)	1.00 Beginner
Manufacturer part number	deviceManufacturerPartNumber	Displays extended manufacturer part number information about the device.	1.00 Beginner
Device Version	DeviceVersion	Displays the device version. This tag will also highlight if the firmware is a beta or custom design. (RO)	1.00 Beginner
Manufacturer Info	DeviceManufacturerInfo	This feature provides extended manufacturer information about the device, such as the firmware design type. (RO)	1.00 Beginner
Firmware Version	DeviceFirmwareVersion	Displays the currently loaded firmware version number. Firmware files have a unique number and have the .cbf file extension. (RO)	1.00 Beginner
Serial Number	DeviceSerialNumber	Displays the device's factory set camera serial number. (RO)	1.00 Beginner
MAC Address	deviceMacAddress	Displays the unique MAC (Media Access Control) address of the Device. (RO)	1.00 DFNC Beginner
Device User ID	DeviceUserID	Feature to store a user-programmable identifier of up to 15 characters. The default factory setting is the camera serial number. (RW)	1.00 Beginner
<u>Power-up Configuration Selector</u>	UserSetDefault	Selects the camera configuration set to load and make active on camera power-up or reset. The camera configuration sets are stored in camera non-volatile memory. (RW)	1.00 Beginner
<i>None</i>	<i>None</i>	<i>Keep Internal configuration.</i>	
<i>Factory Setting</i>	<i>Default</i>	<i>Load factory default feature settings.</i>	
<i>UserSet1</i>	<i>UserSet1</i>	<i>Select the user defined configuration UserSet 1 as the Power-up Configuration.</i>	
<i>UserSet2</i>	<i>UserSet2</i>	<i>Select the user defined configuration UserSet 2 as the Power-up Configuration.</i>	
<i>UserSet3</i>	<i>UserSet3</i>	<i>Select the user defined configuration UserSet 3 as the Power-up Configuration.</i>	
<i>UserSet4</i>	<i>UserSet4</i>	<i>Select the user defined configuration UserSet 4 as the Power-up Configuration.</i>	
<u>User Set Selector</u>	UserSetSelector	Selects the camera configuration set to load feature settings from or save current feature settings to. The Factory set contains default camera feature settings. User camera configuration sets contain features settings previously saved by the user. (RW)	1.00 Beginner
<i>Factory Setting</i>	<i>Default</i>	<i>Select the default camera feature settings saved by the factory.</i>	
<i>UserSet 1</i>	<i>UserSet1</i>	<i>Select the User Defined Configuration space UserSet1 to save to or load from features settings previously saved by the user.</i>	
<i>UserSet 2</i>	<i>UserSet2</i>	<i>Select the User Defined Configuration space UserSet2 to save to or load from features settings previously saved by the user.</i>	
<i>UserSet 3</i>	<i>UserSet3</i>	<i>Select the User Defined Configuration space UserSet3 to save to or load from features settings previously saved by the user.</i>	
<i>UserSet 4</i>	<i>UserSet4</i>	<i>Select the User Defined Configuration space UserSet4 to save to or load from features settings previously saved by the user.</i>	

Load Configuration	UserSetLoad	Loads the camera configuration set specified by the User Set Selector feature, to the camera and makes it active. (W)	1.00 Beginner
Save Configuration	UserSetSave	Saves the current camera configuration to the user set specified by the User Set Selector feature. The user sets are located on the camera in non-volatile memory. (W)	1.00 Beginner
Device Built-In Self Test	deviceBIST	Command to perform an internal test which will determine the device status. (W)	1.00 DFNC Beginner
Device Built-In Self Test Status	deviceBISTStatus	Return the status of the device Built-In Self test. Possible return values are device-specific.  <i>Passed</i> <i>Firmware update failed</i> <i>FPGA Cyclic Redundancy Check Failed</i> <i>Unexpected Error</i>	1.00 Beginner
		<i>Passed</i> <i>FirmwareUpdateFailure</i> <i>FPGA_CRC_Failure</i> <i>Unexpected_Error</i>  <i>No failure detected</i> <i>Last firmware update operation failed.</i> <i>FPGA cyclic redundancy check failed.</i>  <i>Switched to recovery mode due to unexpected software error.</i>	
Device Built-In Self Test Status All	deviceBISTStatusAll	Return the status of the device Built-In Self Test as a bitfield. The meaning for each bit is device-specific.	1.00 DFNC Beginner
Device Reset	DeviceReset	Resets the device to its power up state. (W)	1.00 Beginner
Device Temperature Selector	DeviceTemperatureSelector	Select the source where the temperature is read.	1.00 Beginner
		<i>FPGA Board</i>  <i>FPGABoard</i>  <i>Read FPGA Board temperature</i>	
Device Temperature	DeviceTemperature	The temperature of the selected source in degrees Celsius	1.00 Beginner
overheatedStatus	overheatedStatus	Displays the overheated status of the device. (RO)  <i>OK</i> <i>Overheated</i>	1.00 DFNC Beginner
		<i>OK</i> <i>Overheated</i>  <i>Device temperature does not exceed upper limit.</i> <i>Device temperature exceeds upper limit.</i>	
DeviceID	DeviceID	Displays the device's factory set serial number.	1.00 Invisible
Calibration Date	deviceCalibrationDateRaw	Date when the camera was calibrated.	1.00 DFNC Invisible
Device Acquisition Type	deviceAcquisitionType	Displays the Device Acquisition Type of the product. (RO)	1.00 DFNC Invisible
		<i>Sensor</i>  <i>Sensor</i>  <i>The device gets its data directly from a sensor.</i>	
Device TL Type	DeviceTLType	Transport Layer type of the device.	1.00 Invisible
		<i>GigE Vision</i>  <i>GigEVision</i>  <i>GigE Vision Transport Layer</i>	
Device TL Version Major	DeviceTLVersionMajor	Major version of the device's Transport Layer.	1.00 Invisible
Device TL Version Minor	DeviceTLVersionMinor	Minor version of the device's Transport Layer.	1.00 Invisible
Power-up Configuration Selector	UserSetDefaultSelector	Selects the camera configuration set to load and make active on camera power-up or reset. The camera configuration sets are stored in camera non-volatile memory. (RW)  <i>None</i> <i>Factory Setting</i>  <i>UserSet1 to UserSet4</i>	1.00 Invisible
		<i>None</i> <i>Default</i>  <i>UserSet1 to UserSet4</i>  <i>Keep Internal configuration.</i> <i>Select the Factory Setting values as the Power-up Configuration.</i>  <i>Select the user defined configuration as the Power-up Configuration.</i>	

DFNC Major Rev	deviceDFNCVersionMajor	Major revision of Dalsa Feature Naming Convention which was used to create the device's XML. (RO)	1.00 DFNC Invisible
DFNC Minor Rev	deviceDFNCVersionMinor	Minor revision of Dalsa Feature Naming Convention which was used to create the device's XML. (RO)	1.00 DFNC Invisible
SFNC Major Rev	DeviceSFNCVersionMajor	Major Version of the Standard Features Naming Convention which was used to create the device's XML. (RO)	1.00 Invisible
SFNC Minor Rev	DeviceSFNCVersionMinor	Minor Version of the Standard Features Naming Convention which was used to create the device's XML. (RO)	1.00 Invisible
SFNC SubMinor Rev	DeviceSFNCVersionSubMinor	SubMinor Version of the Standard Features Naming Convention which was used to create the device's XML. (RO)	1.00 Invisible

## Camera Configuration Selection Dialog

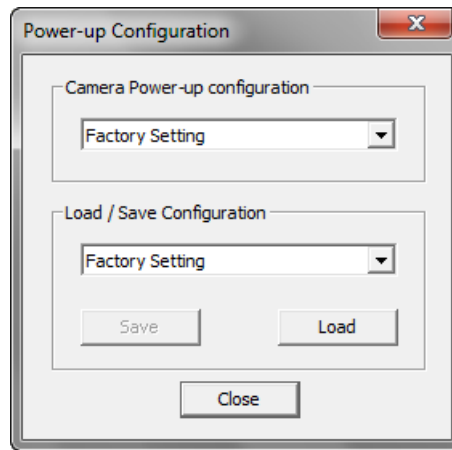

CamExpert provides a dialog box which combines the features to select the camera power up state and for the user to save or load a camera state from Linea GigE memory.

### **Camera Power-up Configuration**

The first drop list selects the camera configuration state to load on power-up (see feature *UserSetDefaultSelector*). The user chooses from one factory data set or one of two possible user saved states.

### **User Set Configuration Management**

The second drop list allows the user to change the camera configuration anytime after a power-up (see feature *UserSetSelector*). To reset the camera to the factory configuration, select *Factory Setting* and click Load. To save a current camera configuration, select User Set 1, 2, 3 or 4 and click Save. Select a saved user set and click Load to restore a saved configuration.

# Sensor Control Category

The Linea GigE sensor controls, as shown by CamExpert, groups sensor specific features. This group includes controls for line rate, exposure time, etc. Parameters in gray are read only, either always or due to another feature being disabled. Parameters in black are user set in CamExpert or programmable via an imaging application.

Features listed in the description table but tagged as *Invisible* are usually for Teledyne DALSA or third party software usage—not typically needed by end user applications.

Category	Parameter	Value
Camera Information	Device Scan Type	Linescan
Sensor Control	Sensor Color Type	Monochrome Sensor
I/O Controls	Sensor Width	4096
Counter And Timer Control	Sensor Height	1
Advanced Processing	Input Pixel Size	12 BPP
Cycling Preset	Acquisition Line Rate	10000
Image Format Controls	Exposure Mode	Timed
Acquisition and Transfer Cont...	Exposure Time	9.71
<input checked="" type="checkbox"/> Device Event Control	Exposure Delay	0.0
GigE Vision Transport Layer	Gain Selector	Digital
File Access Control	Gain	1.0
GigE Vision Host Controls	Black Level Selector	Digital All
	Black Level	0.0
	Line Spatial Correction	1.0
	Sensor Scan Direction	Internal Forward
	Parallax Correction Line Select...	Red_Blue
	Parallax Correction Pixel Stretch	0.0
	<< Less	

## Sensor Control Feature Descriptions

The following table describes these features along with their view attribute and device version. Additionally the description column will indicate which feature is a member of the DALSA Features Naming Convention (indicated by DFNC), versus the GenICam Standard Features Naming Convention (SFNC not shown).

When a Device Version number is indicated, this represents the camera software functional group, not a firmware revision number. As Linea GigE capabilities evolve the device version will increase, therefore identifying the supported function package. New features for a major device version release will be indicated by green text for easy identification.

Display Name	Feature & Values	Description	Device Version & View
Device Scan Type	DeviceScanType	Scan type of the sensor. < RO >	1.00 Beginner
<i>Linescan</i>	<i>Linescan</i>	<i>1D Linescan sensor.</i>	
Sensor Color Type	sensorColorType	Defines the camera sensor color type. < RO >	1.00 Beginner DFNC
	<i>Monochrome Sensor Bayer Sensor CFA_RBGG  CFA_BRGG</i>	<i>Sensor color type is monochrome Sensor color type is Bayer Color Filter Array (CFA) Sensor color type is RBGG (red, blue, green, green). Sensor color type is BRGG (blue, red, green, green).</i>	
Sensor Width	SensorWidth	Defines the sensor width in active pixels. < RO >	1.00 Expert
Sensor Height	SensorHeight	Defines the sensor height in active lines. < RO >	1.00 Expert
Input Pixel Size	pixelSizeInput	Size of the image input pixels, in bits per pixel. < RO >	1.00 Expert DFNC
<i>12 BPP</i>	<i>Bpp12</i>	<i>Sensor output data path is 12 bits per pixel.</i>	
Acquisition Line Rate	AcquisitionLineRate	Specifies the camera internal line rate, in Hz.	1.00 Beginner
<u>Exposure Mode</u>	ExposureMode	Sets the operation mode for the camera's exposure.	1.00 Beginner
<i>Timed</i>	<i>Timed</i>	<i>The exposure duration time is set using the Exposure Time feature and the exposure starts with a LineStart event.</i>	
<i>Trigger Width</i>	<i>TriggerWidth</i>	<i>Uses the width of the trigger signal pulse to control the exposure duration. Use the Trigger Activation feature to set the polarity of the trigger. The Trigger Width setting is applicable when the LineStart trigger is enabled and a signal is selected as trigger source.</i>	
Exposure Time	ExposureTime	Sets the exposure time (in microseconds) when the Exposure Mode feature is set to Timed.	1.00 Beginner
Exposure Delay	exposureDelay	Specifies the delay in microseconds (µs) to apply after the LineStart event before starting the ExposureStart event.	1.00 Beginner DFNC
Gain Selector	GainSelector	Selects which gain is controlled when adjusting gain features.	1.00 Beginner
<i>Digital Digital Red</i>	<i>DigitalAll DigitalRed</i>	<i>Apply a digital gain adjustment to the entire image. Apply a digital gain adjustment to the red channel only.</i>	
<i>Digital Green Digital Blue</i>	<i>DigitalGreen DigitalBlue</i>	<i>Apply a digital gain adjustment to the green channel only. Apply a digital gain adjustment to the blue channel only.</i>	
<u>Gain</u>	Gain	Sets the selected gain as an amplification factor applied to the image.	1.00 Beginner
Black Level Selector	BlackLevelSelector	Selects which tap is controlled by the Black Level feature.	1.00 Beginner
<i>Digital All</i>	<i>DigitalAll</i>		
<u>Black Level</u>	BlackLevel	Black level (offset) in DN	1.00 Expert
Line Spatial Correction	sensorLineSpatialCorrection	Set the number of lines of delay between color planes that are output from the sensor for Spatial Correction.	1.00 Expert DFNC
Sensor Scan Direction	sensorScanDirection	Controls the sensor scan direction.	1.00 Beginner DFNC
<i>Internal Forward</i>	<i>Forward</i>	<i>Internal Forward: The sensor outputs from top to bottom of the sensor line.</i>	



<i>Internal Reverse</i>	<i>Reverse</i>	<i>Internal Reverse: The sensor outputs from bottom to top of the sensor line.</i>	
<i>Line1</i>	<i>Line1</i>	<i>External: The sensor outputs direction is controlled by Line1 level.</i>	
<i>Line2</i>	<i>Line2</i>	<i>External: The sensor outputs direction is controlled by Line2 level.</i>	
<i>Line3</i>	<i>Line3</i>	<i>External: The sensor outputs direction is controlled by Line3 level.</i>	
<i>Line4</i>	<i>Line4</i>	<i>External: The sensor outputs direction is controlled by Line4 level.</i>	
Parallax Correction Line Selector <i>Red_Blue Green</i>	imageDistortionCorrectionParallaxCorrectionSelector <i>Red_Blue Green</i>	Select Parallax Correction either red_blue line or green line	1.00 Beginner DFNC
Parallax Correction Pixel Stretch	imageDistortionParallaxCorrectionPixelStretch	Set Parallax Correction value of either red_blue or green	1.00 Beginner DFNC

## Gain and Black Level Control Details

The Linea GigE camera provides gain and black level adjustments. The gain and black level controls can make small compensations to the acquisition in situations where lighting varies and the lens iris cannot be easily adjusted. Optimal gain and black level adjustments maximizes the Linea GigE dynamic range for individual imaging situations. The user can evaluate Gain and Black Level by using CamExpert.

Features and limitations are described below.

- **Black Level** offset is expressed as a digital number providing a +/- offset from the factory setting. The factory setting optimized the black level offset for maximum dynamic range under controlled ideal dark conditions.
- **Digital Gain** is expressed as a multiplication factor. Note that increasing digital gain does not increase the low level resolution and increases the sensor noise proportionately.

## Exposure Controls Details

Exposure Control modes define the method and timing of controlling the sensor integration period. The integration period is the amount of time the sensor is exposed to incoming light before the video line data is transmitted to the controlling computer.

- Exposure control is defined as the start of exposure and exposure duration.
- The feature **Exposure Mode** selects the controlling method for the exposure.
- The start of exposure can be driven by an internal timer signal, an external trigger signal, or a software function call.
- For External Trigger signals, the relationship between an external line trigger and the exposure period as shown in the timing diagrams below is only applicable while the external line trigger does not exceed the maximum allowable line rate.

### Internal Programmable Exposure

The Linea GigE in the Internal Programmable Exposure mode has the following features:

- The *TriggerSource* feature (see I/O Control category) selects an internal signal as trigger.
- Programmable internal trigger, where the maximum line rate limit is related to the *ExposureTime* feature.
- Exposure duration is user programmable (exposure maximum is dependent on the line rate). Minimum exposure (in  $\mu\text{s}$ ) is model dependent.

### External Programmable Exposure

The External Programmable Exposure mode is similar to Internal Programmable except for the exposure start being an external user input.

- The *TriggerSource* feature (see I/O Control category) selects an external signal line as trigger.
- Line rates and exposure limits are as defined for Internal Programmable Exposure.
- The following timing graphic is an example of an external programmable exposure with exposure time set to  $50\mu\text{s}$  and external trigger activation set 'FallingEdge':

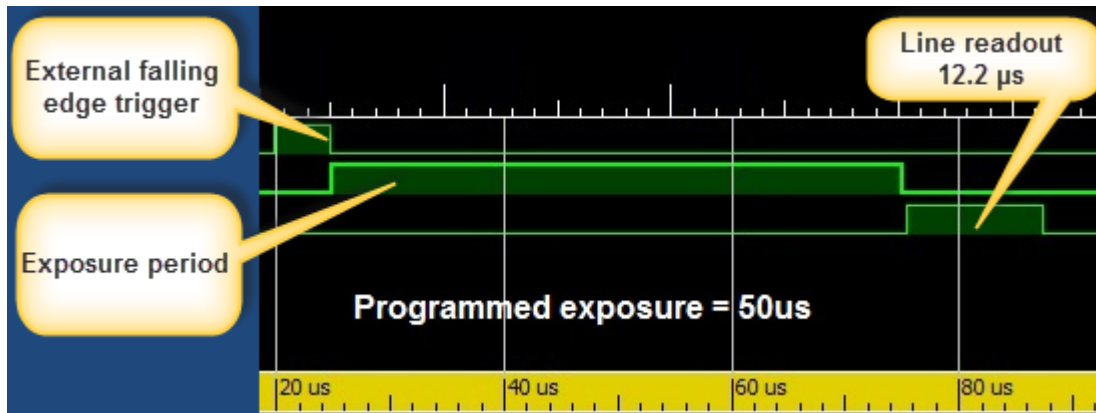

### External Trigger Width Exposure

An alternative external trigger mode allows the external signal width to control the exposure duration (feature ExposureMode = TriggerWidth), as illustrated in the following graphic.

- Note the exposure delay of 12.7 $\mu$ s from the external exposure control.
- Line readout time remains similar to programmable exposure modes.

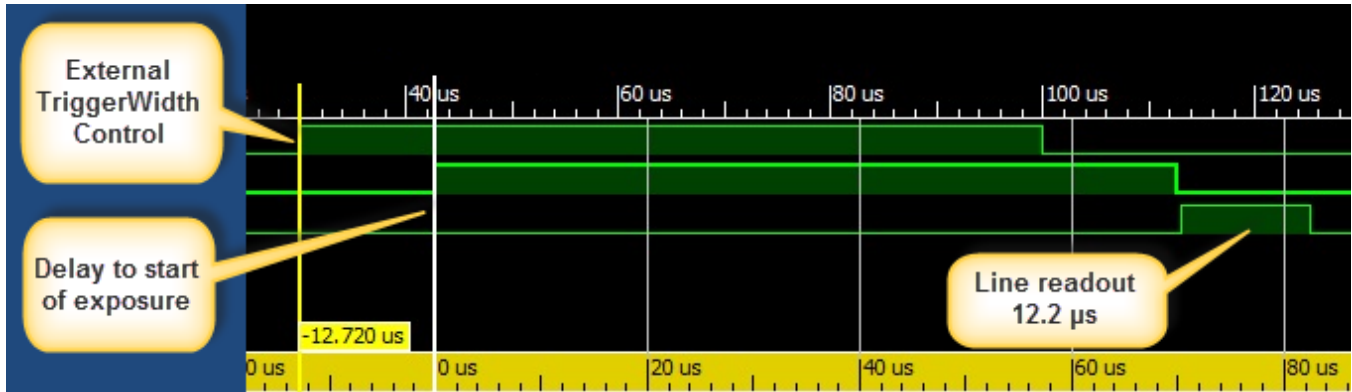

### Exposure and Readout Overlap

The Linea GigE camera allows for the fastest possible line rates by having the line readout period be overlapped with the next exposure period. This is supported in both exposure modes, programmable and external exposure.

The following graphic illustrates an external triggered – short exposure overlapped with the line readout period.

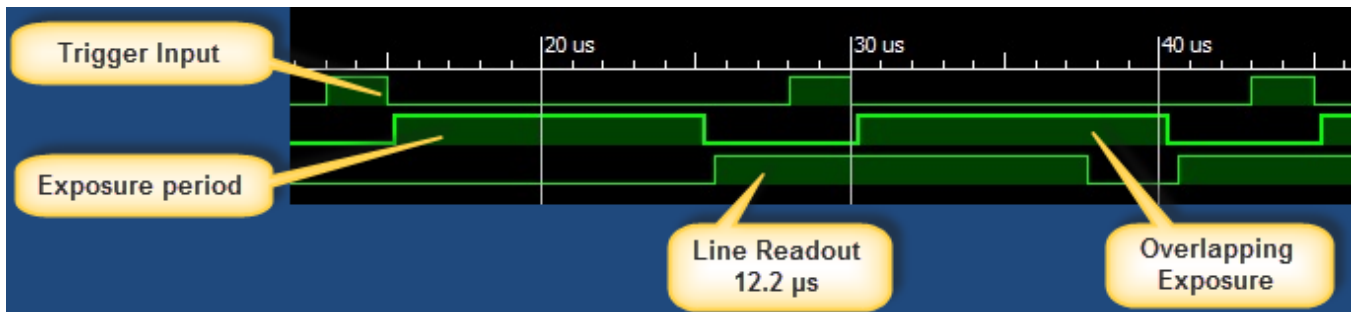

# I/O Control Category

The Linea GigE I/O controls, as shown by CamExpert, group features used to configure external inputs and acquisition actions based on those inputs, plus camera output signals to other devices. Parameters in gray are read only, either always or due to another parameter being disabled. Parameters in black are user set in CamExpert or programmable via an imaging application.

Features listed in the description table but tagged as *Invisible* are usually for Teledyne DALSA or third party software usage—not typically needed by end user applications.

Category	Parameter	Value
Camera Information	Trigger Selector	Single Line Trigger (S...
Sensor Control	Trigger Mode	On
I/O Controls	Trigger Frames Count	Not Enabled
Counter And Timer Control	Software Trigger	Not Enabled
Advanced Processing	Trigger Source	Rotary Encoder
<a href="#">Cycling Preset</a>	Trigger Input Line Activation	Not Enabled
Image Format Controls	Trigger Overlap	Readout
Acquisition and Transfer Control	Trigger Delay	Not Enabled
<b>Device Event Control</b>	Trigger Delay Source	Not Enabled
GigE Vision Transport Layer	Trigger Line Count	1
File Access Control	Line Trigger Input Frequency	9.999999
GigE Vision Host Controls	Rotary Encoder Output Mode	Position
	Rotary Encoder Direction	Counter Clockwise
	Rotary Encoder Input A Source	Line 1
	Rotary Encoder Input B Source	Line 2
	Rotary Encoder Source Activation	Rising Edge
	Rotary Encoder Rescaler Order	Multiplier Divider
	Rotary Encoder Multiplier	1
	Rotary Encoder Divider	1
	Line Selector	Line 1
	Line Format	RS422
	Line Mode	Input
	Input Line Detection Level	Not Enabled
	Line Status	False
	Line Inverter	False
	Input Line Debouncing Period (...)	0
	Line Electrical Termination	Disabled
	Output Line Source	Not Enabled
	Output Line Pulse Signal Activa...	Not Enabled
	Output Line Pulse Delay (in us)	Not Enabled
	Output Line Pulse Duration (in ...)	Not Enabled

## I/O Control Feature Descriptions

The following table describes these features along with their view attribute and minimum camera firmware version required. Additionally the Device Version column will indicate which parameter is a member of the DALSA Features Naming Convention (indicated by DFNC), versus the GenICam Standard Features Naming Convention (SFNC not shown).

The Device Version number represents the camera software functional group, not a firmware revision number. As Linea GigE capabilities evolve the device version tag will increase, therefore identifying the supported function package. New features for a major device version release will be indicated by green text for easy identification.

Display Name	Feature & Values	Description	Device Version & View
Trigger Selector	TriggerSelector	Selects which type of trigger to configure with the various Trigger features.	1.00 Beginner
<i>Single Line Trigger (Start)</i>	<i>LineStart</i>	<i>Selects a trigger starting the capture of a single line.</i>	
<i>Single Frame Trigger(Start)</i>	<i>FrameStart</i>	<i>Selects a trigger starting the capture of a single frame. Frame size is determined by image format feature "Height".</i>	
<i>MultiFrame Trigger(Start)</i>	<i>FrameBurstStart</i>	<i>Selects a trigger to capture multiple frames. The number of frames is specified by the triggerFrameCount feature.</i>	
<i>Frame Active</i>	<i>FrameActive</i>	<i>Selects a trigger controlling the duration of one frame.</i>	
<i>Frame Burst Active</i>	<i>FrameBurstActive</i>	<i>Selects a trigger controlling the frame(s) duration. One trigger can start many frames if the duration exceeds the size of one frame.</i>	
<u>Trigger Mode</u>	TriggerMode	Controls the enable state of the selected trigger.	1.00 Beginner
<i>Off</i>	<i>Off</i>	<i>The selected trigger is turned off.</i>	
<i>On</i>	<i>On</i>	<i>The selected trigger is turned active.</i>	
Trigger Frames Count	triggerFrameCount	Sets the number of frames to acquire when a valid trigger is received. This feature is available when the Trigger Selector is set to MultiFrames Trigger.	1.00 DFNC Beginner
Trigger Line Count	triggerLineCount	Sets the number of lines to acquire when a valid line trigger pulse is received.	1.00 DFNC Beginner
Software Trigger	TriggerSoftware	Generate a software command internal trigger immediately no matter what the TriggerSource feature is set to.	1.00 Beginner
Trigger Source	TriggerSource	Specifies the internal signal or physical input line to use as the trigger source. The selected trigger must have its TriggerMode set to ON. Note, source availability may depend on the TriggerSelector setting. See Input Signals Electrical Specifications.	1.00 Beginner
<i>Line 1</i>	<i>Line1</i>	<i>Select Line 1 (and associated I/O control block) to use as the external trigger source. See LineSelector feature for a complete list.</i>	
<i>Line 2</i>	<i>Line2</i>	<i>External Trigger on Line 2.</i>	
<i>Line 3</i>	<i>Line3</i>	<i>External Trigger on Line 3.</i>	
<i>Line 4</i>	<i>Line4</i>	<i>External Trigger on Line 4.</i>	
<i>Rotary Encoder</i>	<i>rotaryEncoder1</i>	<i>Select Rotary Encoder to use as the external line trigger source.</i>	
<i>Timer1End Event</i>	<i>Timer1End</i>	<i>Select the Timer1End Event as the internal trigger source.</i>	

<i>Timer2End Event</i>	<i>Timer2End</i>	Select the <i>Timer2End Event</i> as the internal trigger source.	
<i>Counter1End Event</i>	<i>Counter1End</i>	Select the <i>Counter1End Event</i> as the internal~trigger source.	
<i>Counter2End Event</i>	<i>Counter2End</i>	Select the <i>Counter2End Event</i> as the internal trigger source.	
<i>Timer1 Active</i>	<i>Timer1Active</i>	Select the <i>Timer1Active</i> signal as the internal trigger source.	
<i>Timer2 Active</i>	<i>Timer2Active</i>	Select the <i>Timer2Active</i> signal as the internal trigger source.	
<i>Counter1 Active</i>	<i>Counter1Active</i>	Select the <i>Counter1Active</i> signal as the internal trigger source.	
<i>Counter2 Active</i>	<i>Counter1Active</i>	Select the <i>Counter2Active</i> signal as the internal trigger source.	
Trigger Input Line Activation	TriggerActivation	Select the activation mode for the selected Input Line trigger source. This is applicable only for external line input lines.	1.00 Beginner
<i>Rising Edge</i>	<i>RisingEdge</i>	The trigger is considered valid on the rising edge of the line source signal (after any processing by the line inverter module).	
<i>Falling Edge</i>	<i>FallingEdge</i>	The trigger is considered valid on the falling edge.	
<i>Any Edge</i>	<i>AnyEdge</i>	The trigger is considered valid on any edge ...	
<i>Level High</i>	<i>LevelHigh</i>	The trigger is considered valid as long as the level of the source signal is high.	
<i>Level Low</i>	<i>LevelLow</i>	The trigger is considered valid as long as the level of the source signal is low.	
Trigger Overlap	TriggerOverlap	Specifies if a trigger overlap is permitted with the Active Frame or Active Line signal. This defines if a new valid trigger will be accepted (or latched) for a new frame or line.	1.00 Beginner
<i>Off</i>	<i>Off</i>	No trigger overlap is permitted. (Frame Trigger).	
<i>Readout</i>	<i>ReadOut</i>	Trigger is accepted immediately after the exposure period (readout). (Line Trigger) Overlapped exposures must not end before readout of the previous exposure.	
<i>Previous Line</i>	<i>previousLine</i>	Trigger is accepted (latched) at any time during the capture of the previous line. (Line Trigger)	
Trigger Delay	TriggerDelay	Only frame triggers can be delayed. Specifies the delay to apply after receiving the trigger and before activating <i>triggerEvent</i> . The delay can be set in microseconds or in line trigger signals. The delayer can buffer and apply the specified delay to a maximum of 128 frame trigger pulses simultaneously. Any additional triggers will be lost if the trigger delayer buffer is full.	1.00 Beginner
Trigger Delay Source	triggerDelaySource	Sets the event that increments the trigger delay counter.	1.00 DFNC Beginner
<i>Internal Clock</i>	<i>InternalClock</i>	The delay counter increments on each microsecond tick of the device internal Clock.	
<i>Line Trigger Signal</i>	<i>lineTriggerSignal</i>	The delay counter increments on each pulse received by the line trigger module. The delay counter increments even if the pulse is rejected by the line trigger module.	
Line Trigger Input Frequency	lineTriggerInputFrequency	Current line frequency measured by the camera.	1.00 Beginner
Rotary Encoder Output Mode	rotaryEncoderOutputMode	Specifies the conditions for the Rotary Encoder interface to generate a valid Encoder output signal.	1.00 Expert DFNC

<i>Position</i>	<i>Position</i>	<i>On the camera, the "position" behaviour exists, but the number of counts is small (7-bits / 128 counts). The encoder can reverse for 256 ticks and then go forward and behave as expected for "position" style behaviour. If the user exceeds 256 ticks, the count will max out, but will not reset. When the user starts going forward again, 256 lines will be dropped / ignored and then resume output.</i>	
<i>Motion</i>	<i>Motion</i>	<i>The triggers are generated for all motion increments in either direction.</i>	
Rotary Encoder Rescaler Order  <i>Multiplier Divider</i> <i>Divider Multiplier</i>	rotaryEncoderRescalerOrder  <i>multiplierDivider</i> <i>dividerMultiplier</i>	Specifies the order that the multiplier and divider are applied.  <i>The signal is multiplied before been divided.</i> <i>The signal is divided before been multiplied.</i>	1.00 Guru DFNC
Rotary Encoder Multiplier	rotaryEncoderMultiplier	Specifies a multiplication factor for the rotary encoder output pulse generator.	1.00 DFNC Beginner
Rotary Encoder Divider	rotaryEncoderDivider	Specifies a division factor for the rotary encoder output pulse generator.	1.00 DFNC Beginner
Rotary Encoder Direction  <i>Clockwise</i>  <i>Counter Clockwise</i>	rotaryEncoderDirection  <i>Clockwise</i>  <i>CounterClockwise</i>	Specifies the phase which defines the encoder forward direction.  <i>Inspection goes forward when the rotary encoder direction is clockwise (phase B is ahead of phase A).</i> <i>Inspection goes forward when the rotary encoder direction is counter clockwise (phase A is ahead of phase B).</i>	1.00 Expert DFNC
Rotary Encoder Input A Source  <i>Line 1</i> <i>Line 3</i>	rotaryEncoderInputASource  <i>Line1</i> <i>Line3</i>	Selects which input line to assign to the rotary encoder input A (also known as shaft encoder). Note that the Line Mode feature must be set to Input. The list of supported input line sources is device-specific.  <i>Line1 is assigned to the Rotary Encoder Input A</i> <i>Line3 is assigned to the Rotary Encoder Input A</i>	1.00 Expert DFNC
Rotary Encoder Input B Source  <i>GND</i> <i>Line 2</i> <i>Line 4</i>	rotaryEncoderInputBSource  <i>GND</i> <i>Line2</i> <i>Line4</i>	Selects which input line to assign to the rotary encoder input B (also known as shaft encoder). Note that the Line Mode feature must be set to Input. The list of supported input line sources is device-specific.  <i>Rotary Encoder Input B is not used</i> <i>Line2 is assigned to the Rotary Encoder Input B</i> <i>Line4 is assigned to the Rotary Encoder Input B</i>	1.00 Expert DFNC
Rotary Encoder Source Activation  <i>Rising Edge</i>  <i>Any Edge</i>	rotaryEncoderSrcActivation  <i>RisingEdge</i>  <i>AnyEdge</i>	Specifies the signal edge(s) use to increment the rotary encoder.  <i>The rotary encoder uses the rising edge of the source signal.</i> <i>The rotary encoder uses either the rising edge or falling edge of the source signal.</i>	1.00 Expert DFNC
Rotary Encoder Multiplier	rotaryEncoderMultiplier	Specifies a multiplication factor for the rotary encoder output pulse generator.	1.00 Expert DFNC
Rotary Encoder Divider	rotaryEncoderDivider	Specifies a division factor for the rotary encoder output pulse generator.	1.00 Expert DFNC
Line Selector	LineSelector	Selects the physical line (or pin) of the external device connector to configure.	1.00 Beginner

Line 1 Line 2 Line 3 Line 4 Line 5 Line 6	Line1 Line2 Line3 Line4 Line5 Line6	Index of the physical line and associated I/O control block to use.	
Line Format  SingleEnded  Open Collector RS422	LineFormat  SingleEnded  OpenCollector RS422	Specify the current electrical format of the selected physical input or output. Applies to all physical lines. (RO)  The line is single ended input for 3.3V/5V/12V/24V or output for 3.3V LVTTTL  The line is output as open collector.  The line accepts or sends RS422 level signals.	1.00 Expert
Line Mode  Input Output	LineMode  Input Output	Reports if the physical Line is an Input or Output signal. (RO) See Input Signals Electrical Specifications. See Output Signals Electrical Specifications.  The line is an input line.  The line is an output line.	1.00 Expert
Input Line Detection Level  Threshold for 3.3V LVTTTL	lineDetectionLevel  Threshold_for_3V3	Specifies the voltage threshold required to recognize a signal transition on an input line.  A signal below 1.5V will be detected as a Logical LOW and a signal greater than 1.5V will be detected as a Logical HIGH on the selected input line.	1.00 Expert DFNC
Threshold for 5V TTL	Threshold_for_5V	A signal below 2.5V will be detected as a Logical LOW and a signal greater than 2.5V will be detected as a Logical HIGH on the selected input line.	
Threshold for 12V	Threshold_for_12V	A signal below 5.0V will be detected as a Logical LOW and a signal greater than 5.0V will be detected as a Logical HIGH on the selected input line.	
Threshold for 24V	Threshold_for_24V	A signal below 5.0V will be detected as a Logical LOW and a signal greater than 5.0V will be detected as a Logical HIGH on the selected input line.	
Line Status	LineStatus  False / True	Returns the current status of the selected input or output line. (RO)	1.00 Expert
Line Inverter	LineInverter  False / True	Controls whether to invert the polarity of the selected input or output line signal.	1.00 Beginner
Input Line Debouncing Period	lineDebouncingPeriod	Specifies the minimum delay before an input line voltage transition is recognizing as a signal transition.	1.00 Beginner DFNC
Line Electrical Termination  Disabled  Enabled	lineElectricalTermination  Disabled  Enabled	Controls if the electrical termination of the selected line is enabled or disabled.  Disables electrical line termination for the selected line.  Enables electrical line termination for the selected line.	1.00 Expert DFNC
<u>Output Line Source</u>  Off  Software Controlled	outputLineSource  Off  SoftwareControlled	Selects which internal signal or event driven pulse or software control state to output on the selected line. Note, the LineMode feature must be set to Output. The List of supported output line sources is product-specific. The <a href="#">Event Control section</a> provides details and timing diagrams for the supported trigger modes.  Line output is Open  The OutputLineValue feature changes the state of the output	1.00 Beginner DFNC



<i>Pulse on: Start of Frame</i>	<i>PulseOnStartofFrame</i>	<i>Generate a pulse on the start of the Frame Active event</i>	
<i>Pulse on: Start of Line</i>	<i>PulseOnStartofLine</i>	<i>Generate a pulse on the start of the Line Active</i>	
<i>Pulse on: Start of Exposure</i>	<i>PulseOnStartofExposure</i>	<i>Generate a pulse on the ExposureStart event. This option is typically used to trigger a strobe light.</i>	
<i>Pulse on: End of Exposure</i>	<i>PulseOnEndofExposure</i>	<i>Generate a pulse on the ExposureEnd event. This option is typically used to trigger a strobe light.</i>	
<i>Pulse on: Start of Readout</i>	<i>PulseOnStartofReadout</i>	<i>Generate a pulse on the ReadoutStart event.</i>	
<i>Pulse on: End of Readout</i>	<i>PulseOnEndofReadout</i>	<i>Generate a pulse on the ReadoutEnd event.</i>	
<i>Pulse on: Valid Line Trigger</i>	<i>PulseOnValidLineTrigger</i>	<i>Generate a pulse on the LineTrigger event.</i>	
<i>Pulse on: Invalid Line Trigger</i>	<i>PulseOnInvalidLineTrigger</i>	<i>Generate a pulse on the Invalid LineTrigger event.</i>	
<i>Pulse on: Start of Acquisition</i>	<i>PulseOnStartofAcquisition</i>	<i>Generate a pulse when the AcquisitionStart event occurs</i>	
<i>Pulse on: End of Acquisition</i>	<i>PulseOnEndofAcquisition</i>	<i>Generate a pulse when the AcquisitionStop event occurs</i>	
<i>Pulse on: End of Timer 1</i>	<i>PulseOnTimer1End</i>	<i>Generate a pulse on the TimerEnd 1 event.</i>	
<i>Pulse on: End of Timer 2</i>	<i>PulseOnTimer2End</i>	<i>Generate a pulse on the TimerEnd 2 event.</i>	
<i>Pulse on: End of Counter 1</i>	<i>PulseOnCounter1End</i>	<i>Generate a pulse on the CounterEnd 1 event.</i>	
<i>Pulse on: End of Counter 2</i>	<i>PulseOnCounter2End</i>	<i>Generate a pulse on the CounterEnd 2 event.</i>	
<i>Pulse on: Input Line 1 Event</i>	<i>PulseOnInput1</i>	<i>Generate a pulse on the Input signal 1 event</i>	
<i>Pulse on: Input Line 2 Event</i>	<i>PulseOnInput2</i>	<i>Generate a pulse on the Input signal 2 event</i>	
<i>Pulse on: Input Line 3 Event</i>	<i>PulseOnInput3</i>	<i>Generate a pulse on the Input signal 3 event</i>	
<i>Pulse on: Input Line 4 Event</i>	<i>PulseOnInput4</i>	<i>Generate a pulse on the Input signal 4 event</i>	
<i>Pulse on: Rotary Encoder 1</i>	<i>PulseOnRotaryEncoder1</i>	<i>Generate a pulse on the Rotary Encoder 1 event</i>	
<i>Pulse on: Software Command</i>	<i>PulseOnSoftwareCmd</i>	<i>Generate a pulse on the Input of a Software Command</i>	
<i>Frame Trigger</i>	<i>FrameTriggerActive</i>	<i>Generate a signal that is active when the frame trigger is active</i>	
<i>Frame Valid</i>	<i>FrameActive</i>	<i>Generate a signal that is active when the Frame is active</i>	
<i>Exposure Active</i>	<i>ExposureActive</i>	<i>Generate a signal that is active when the Exposure is active</i>	
<i>Line Active</i>	<i>ReadoutActive</i>	<i>Generate a signal that is active when the line valid is active</i>	
<i>Smart Strobe Active</i>	<i>SmartStrobeActive</i>	<i>Generate a signal that is active when the Readout or the ExposureDelay are active. The smart strobe only works when triggerLineCount is greater than 1</i>	
Output Line Pulse Signal Activation	outputLinePulseActivation	Specifies the input line activation mode to trigger the OutputLine pulse.	1.00 Beginner DFNC
<i>Rising Edge</i>	<i>RisingEdge</i>	<i>Specifies that the trigger is considered valid on the rising edge of the source signal.</i>	
<i>Falling Edge</i>	<i>FallingEdge</i>	<i>Specifies that the trigger is considered valid on the falling edge of the source signal.</i>	
<i>Any Edge</i>	<i>AnyEdge</i>	<i>Specifies that the trigger is considered valid on the falling or rising edge of the source signal.</i>	
Output Line Pulse Delay	outputLinePulseDelay	Sets the delay (in $\mu\text{s}$ ) before the output line pulse signal. Applicable for the OutputLineSource feature. Note, the LineMode feature must be set to output.	1.00 Beginner DFNC
Output Line Pulse Duration	outputLinePulseDuration	Sets the width (duration) of the output line pulse in microseconds.	1.00 Beginner DFNC
Output Line Software Latch Control	outputLineSoftwareLatchControl	When Off, the selected output line is set with the value in Output Line Value. (RO)	1.00 Guru DFNC
<i>Off Latch</i>	<i>Off Latch</i>	<i>Output pin state set by outputLineValue. Output pin state set by outputLineSoftwareCmd.</i>	

Output Line Value	outputLineValue	<p>Sets the output state of the selected Line if the outputLineSoftwareLatchControl = OFF. OutputLineSource must be SoftwareControlled. If the outputLineSoftwareLatchControl = Latch , the state of the pin will change with the outputLineSoftwareCmd command.</p> <p><i>Sets the Output circuit to close</i></p> <p><i>Sets the Output circuit to open</i></p>	1.00 Beginner DFNC
Line Status All	LineStatusAll	Returns the current status of all available line signals, at time of polling, in a single bitfield. The order is Line1, Line2, Line3, ... (RO)	1.00 Expert
Output Line Software Command	outputLineSoftwareCmd	<p>Writing a value of 1 in the bit field applies the Latch value of the outputLineSoftwareLatchControl and/or executes the PulseOnSoftwareCmd for any output line programmed for software control. The feature outputLineSoftwareCmd can take any binary value and each bit set to 1 corresponds to a Icommand for an Output.</p> <p>Bit-0 is Line 3, Bit-1 is Line 4, Bit-2 is Line 5, Bit-3 is Line 6</p> <p>This is applicable to OutputLineSource = Pulse On: where Software Cmd (for Pulse mode) or OutputLineSource = SoftwareControlled and OutputLineSoftwareLatchControl = Latch (for static states).</p>	1.00 Expert DFNC

## I/O Module Block Diagram

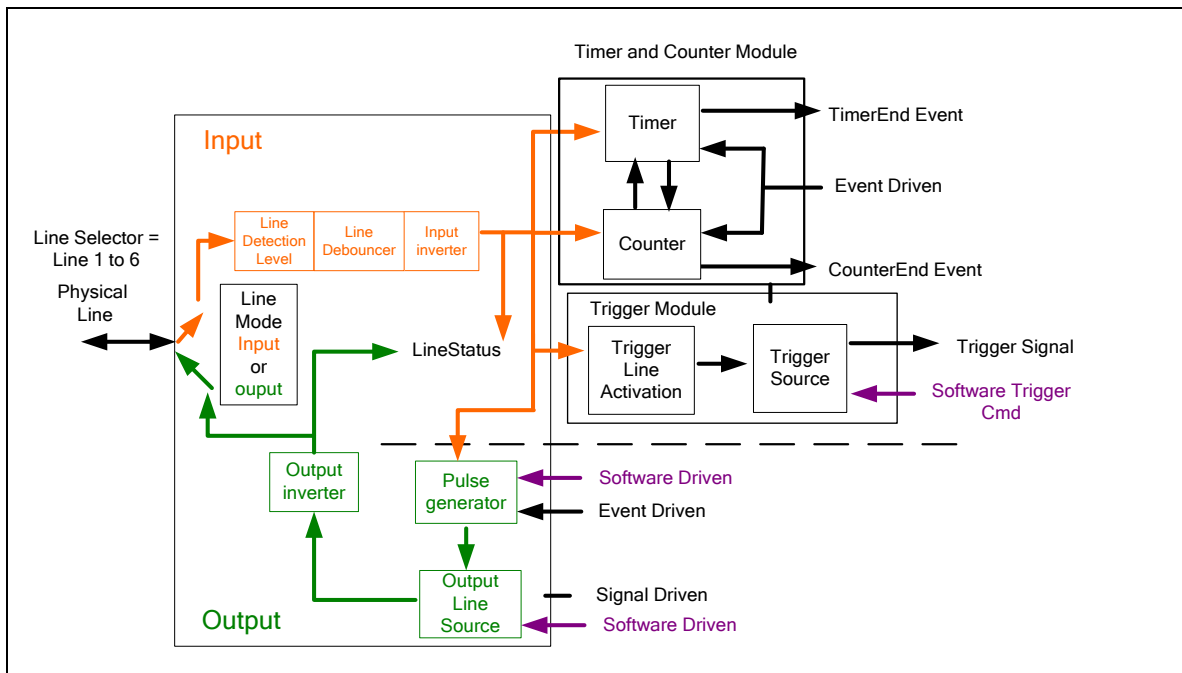

## Trigger Overview

Linea GigE line exposures are initiated by a trigger event. A trigger is either the camera's programmable internal clock used in free running mode, an external input used for synchronizing exposures to external triggers, or a programmed function call message by the controlling computer. These triggering modes are described below.

- **Free running — Line or Frame (Trigger Mode = Off):** The Linea GigE free-running mode has programmable internal timers for line rate/exposure period and frame rates. Line rate and frame rates are independent. Frame free running simply means acquire all lines.
- **External trigger (Trigger Mode = On):** Exposures are controlled by an external or internal trigger signal where the specific input line or source is selected by the **Trigger Source** feature. External signal inputs have a time programmable debounce circuit.
- **Virtual Frames:** For any exposure type the virtual frame (i.e. the number of exposure lines per frame) is set by the Image Format Height feature of the Image Format Category.

### Trigger Selector Details

- **Single Frame Trigger (Start) "FrameStart":** Starts the acquisition of one frame when the acquisition is active. The number of lines in the frame is defined by the feature "Height".
- **Frame Active Trigger "FrameActive":** Starts acquisition of one frame when the acquisition is active. The number of lines in the frame is controlled by the trigger signal width.
  - If the frame active trigger period is greater than the feature "Height" value, the frame acquisition is limited to the "Height" lines value and then waits for the next frame active trigger.
  - If the frame active trigger period is less than the feature "Height" value, the frame acquisition is limited to the lines within the trigger width period and then waits for the next frame active trigger.

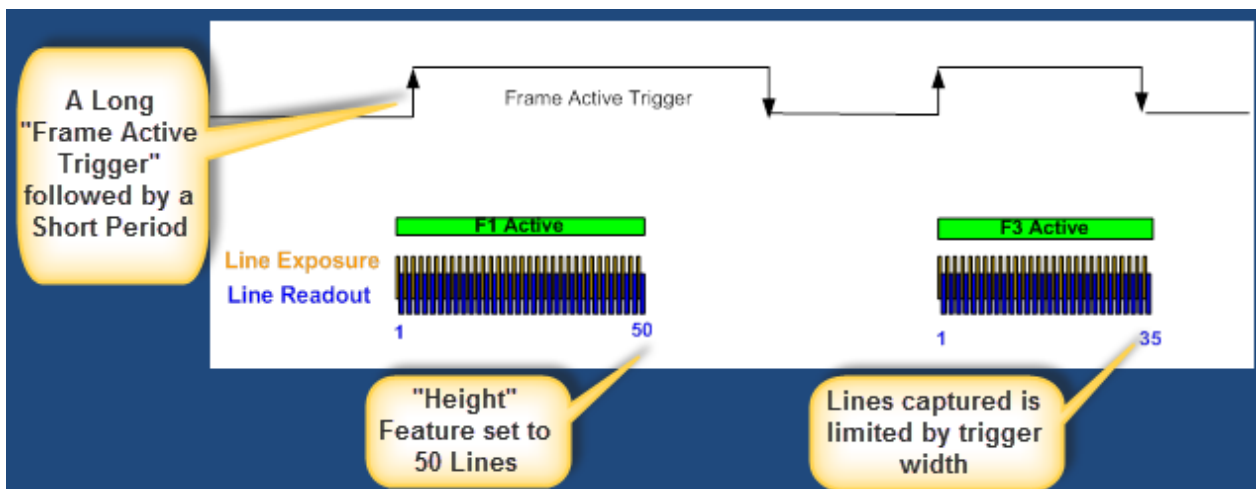

- **MultiFrame Trigger (Start) "FrameBurstStart":** Burst start trigger starts the capture of a number of frames of "Height" lines. No line is lost between frames. The number of frames in this burst mode is defined by the feature "AcquisitionBurstFrameCount".
- **Frame Burst Active Trigger "FrameBurstActive":** Frame burst active trigger is used for multi-frame acquisitions. The number of lines in a frame is controlled by the width of the trigger, up to the value "Height".

- If the number of lines within the frame active trigger is greater than the feature "Height", the frame active trigger will produce more than one frame.
- If the number of lines within the frame active trigger is less than the feature "Height", the frame height is less than the feature "Height".
- The maximum number of frames possible in "FrameBurstActive" mode is set by the feature "AcquisitionBurstFrameCount".

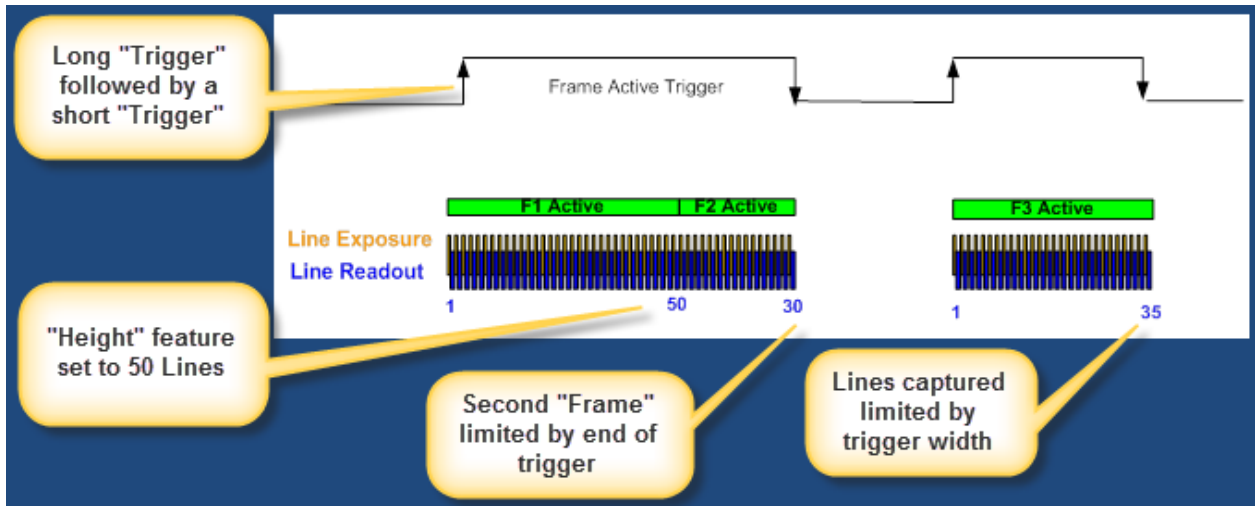

### Trigger Source Types

- **Trigger Source=Line x:** Select the Line Input used as an external trigger.
- **Trigger Source=Rotary Encoder:** External trigger is via one or both Rotary Encoder inputs. A number of features allow selecting encoder signal direction, scaling, etc. to suit the imaging application.
- **Trigger Source=Timer1End Event:** The Timer1 End Event (or Timer2) is used as the internal trigger source. Refer to [Counter and Timer Controls](#) for information on those features.
- **Trigger Source=Counter1End Event:** The Counter1 End Event (or Counter2) is used as the internal trigger source.
- **Trigger Line Polarity:** Select rising or falling edge detection.

### Input Line Details

The input line signals have the following features for control or status indication.

- **Feature set:** LineSelector (RW), LineFormat (RW), LineMode (RW), lineDebouncingPeriod (RW), LineInverter (RW), LineStatus (RO), lineDetectionLevel.
- **Connector:** See HD15 type Connector Details for connector pin out and electrical information. The cable shell and shield should electrically connect the Linea GigE chassis to computer chassis for maximum EMI protection.
- **Line Transition Validation:** Each input incorporates a signal debounce circuit to eliminate short noise transitions that could be wrongly interpreted as a valid pulse. The duration is user-programmable from 0 $\mu$ s to 255 $\mu$ s with CamExpert.
- **Line Input Signal Characteristics:** See Input Signals Electrical Specifications.

## ***Output Line Details***

The general purpose output line signals either dedicated or shared with inputs. See HD15 type Connector Details for connector pinout and electrical information.

- **Feature set:** LineInverter (RW), outputLineSource (RW), outputLinePulseDelay (RW), outputLinePulseDuration (RW), outputLineValue (RW), outputLineSoftwareCmd (RW), LineSelector (RW), LineFormat (RW), LineMode (RW), LineStatus (RO). See Output Signals Electrical Specifications for more information.
- **External outputs:** Can be used as a strobe signals to control lighting or to generate programmable pulses when specific events are generated by the camera.
- **Output on Events:** Each output can be set independently to one of the available event modes defined by the 'outputLineSource' feature. The output delay can be set from 0 to 16 seconds, in increments of 1  $\mu$ s. The pulse duration can be set from 0 to 16 seconds, in increments of 1  $\mu$ s.

### ***Example of Free Run Line Mode with Frame Trigger***

An example setup of free run line acquisition with Frame Trigger with a configurable internal timer is used as follows:

- Set "AcquisitionLineRate" as 20000Hz
- Set image Height as 100
- Select "TriggerSelector" as "SingleFrameTrigger(Start)"
- Set "TriggerMode" as "On"
- Select TriggerSource as "Timer1EndEvent"
- Setup Timer1:
  - Set its TimerStartSource as "Timer1End"
  - TimerDuration as 5000
  - TimerMode set as "Active"

Then click on the CamExpert "Grab" button.

### ***Example of Line Trigger Mode***

An example setup of a Line Trigger acquisition using internal timer with a configurable internal timer is as follows:

- Set image "Height" as 100
- Select "TriggerSelector" as "SingleLineTrigger(Start)"
- Set "TriggerMode" as "On"
- Select TriggerSource as "Timer1EndEvent"
- Setup Timer1:
  - Set its TimerStartSource as "Timer1End"
  - TimerDuration as 100
  - TimerMode set as "Active"

Then click on the CamExpert "Grab" button.

### ***Example of Line Trigger plus Frame Trigger Combined***

An example setup the Line Trigger mode combined with Frame Trigger using the configurable internal timers is as follows:

- Set image "Height" as 80
- Select "TriggerSelector" as "SingleLineTrigger(Start)"
- Set "TriggerMode" as "On"
- Select TriggerSource as "Timer1EndEvent"
- Select "TriggerSelector" as "SingleFrameTrigger(Start)"
- Set "TriggerMode" as "On"
- Select TriggerSource as "Timer2EndEvent"
- Set Timer1 "TimeDuration" as 100, and "TimerMode" as "Active"
- Set Timer2 "TimeDuration" as 10000, and "TimerMode" as "Active"

Then click on the CamExpert "Grab" button.

## Counter and Timer Control Category

The Linea GigE counter and timer controls, as shown by CamExpert, groups parameters used to configure acquisition counters and timers for various input lines and signal edge detection. Parameters in gray are read only, either always or due to another parameter being disabled. Parameters in black are user set in CamExpert or programmable via an imaging application.

Features listed in the description table but tagged as *Invisible* are usually for Teledyne DALSA or third party software usage—not typically needed by end user applications.

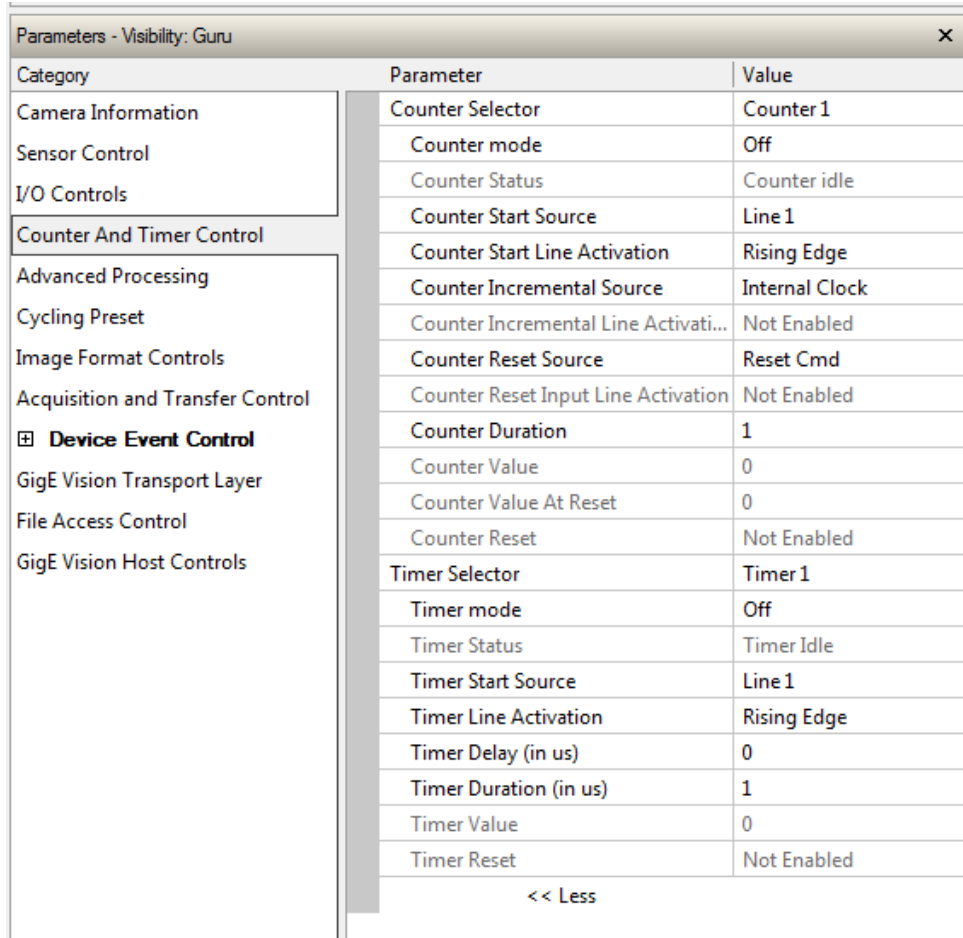

Category	Parameter	Value
Camera Information	Counter Selector	Counter 1
Sensor Control	Counter mode	Off
I/O Controls	Counter Status	Counter idle
<b>Counter And Timer Control</b>	Counter Start Source	Line 1
Advanced Processing	Counter Start Line Activation	Rising Edge
Cycling Preset	Counter Incremental Source	Internal Clock
Image Format Controls	Counter Incremental Line Activati...	Not Enabled
Acquisition and Transfer Control	Counter Reset Source	Reset Cmd
<input checked="" type="checkbox"/> <b>Device Event Control</b>	Counter Reset Input Line Activation	Not Enabled
GigE Vision Transport Layer	Counter Duration	1
File Access Control	Counter Value	0
GigE Vision Host Controls	Counter Value At Reset	0
	Counter Reset	Not Enabled
	Timer Selector	Timer 1
	Timer mode	Off
	Timer Status	Timer Idle
	Timer Start Source	Line 1
	Timer Line Activation	Rising Edge
	Timer Delay (in us)	0
	Timer Duration (in us)	1
	Timer Value	0
	Timer Reset	Not Enabled

<< Less

## Counter and Timer Control Feature Description

The following table and [block diagram](#), describes these parameters along with their view attribute and minimum camera firmware version required. Additionally the Device Version column will indicate which parameter is a member of the DALSA Features Naming Convention (indicated by DFNC), versus the GenICam Standard Features Naming Convention (SFNC not shown).

The Device Version number represents the camera software functional group, not a firmware revision number. As Linea GigE capabilities evolve the device version tag will increase, therefore identifying the supported function package. New features for a major device version release will be indicated by green text for easy identification.

Display Name	Feature & Values	Description	Device Version & View
Counter Selector <i>Counter 1</i> <i>Counter 2</i>	counterSelector <i>Counter1</i> <i>Counter2</i>	Selects the counter to configure. <i>Select counter 1</i> <i>Select counter 2</i>	1.00 Expert DFNC
Counter mode  <i>Off</i> <i>Active</i>	counterMode  <i>Off</i> <i>Active</i>	Selects the counter mode. The selected Counter is either Active or Disabled. When Disabled, the Counter can be configured.  <i>The selected Counter is Disabled</i> <i>The selected Counter is Enabled</i>	1.00 Expert DFNC
Counter Status  <i>Counter Idle</i>  <i>Counter Trigger Wait</i> <i>Counter Active</i> <i>Counter Completed</i> <i>Counter Overflow</i>	counterStatus  <i>CounterIdle</i>  <i>CounterTriggerWait</i> <i>CounterActive</i> <i>CounterCompleted</i> <i>CounterOverflow</i>	Returns the current state of the counter. (RO)  <i>The counter is idle.</i> <i>The CounterStartSource feature is set to off.</i>  <i>The counter is waiting for a start trigger.</i>  <i>The counter is counting for the specified duration.</i>  <i>The counter reached the CounterDuration count.</i>  <i>The counter reached its maximum possible count.</i>	1.00 Expert DFNC
<u>Counter Start Source</u>  <i>Off</i> <i>Acquisition Start</i>  <i>Acquisition End</i>  <i>Exposure Start</i>  <i>Exposure End</i>  <i>Readout Start</i>  <i>Readout End</i>  <i>Frame Start</i>  <i>Line 1</i> <i>Line 2</i> <i>Line 3</i> <i>Line 4</i> <i>Timer 1 End</i> <i>Timer 2 End</i>  <i>Counter 1 End</i>  <i>Counter 2 End</i>	counterStartSource  <i>Off</i>  <i>AcquisitionStart</i>  <i>AcquisitionEnd</i>  <i>ExposureStart</i>  <i>ExposureEnd</i>  <i>ReadoutStart</i>  <i>ReadoutEnd</i>  <i>FrameStart</i>  <i>Line1</i> <i>Line2</i> <i>Line3</i> <i>Line4</i> <i>Timer1End</i> <i>Timer2End</i>  <i>Counter1End</i>  <i>Counter2End</i>	Select the counter start source. Counter increments from 0 to the value of the counterDuration feature.  <i>Counter is stopped.</i>  <i>Counter starts on the reception of the Acquisition Start event.</i>  <i>Counter starts on the reception of the Acquisition End event.</i>  <i>Counter starts on the reception of the Exposure Start event</i>  <i>Counter starts on the reception of the Exposure End event.</i>  <i>Counter starts on the reception of the Readout Start event.</i>  <i>Counter starts on the reception of the Readout End event.</i>  <i>Counter starts on the reception of the Frame Start event.</i>  <i>Counter starts on the specified transitions on Line 1</i> See Input Signals Electrical Specifications.  <i>Counter starts on the specified transitions on Line 2</i>  <i>Counter starts on the specified transitions on Line 3</i>  <i>Counter starts on the specified transitions on Line 4</i>  <i>Counter starts on the reception of the Timer 1 End event.</i>  <i>Counter starts on the reception of the Timer 2 End event.</i>  <i>Counter starts on the reception of the Counter 1 End event.</i>  <i>Counter starts on the reception of the Counter 2 End event.</i>	1.10 Expert DFNC
Counter Start Line Activation  <i>Rising Edge</i> <i>Falling Edge</i> <i>Any Edge</i>	counterStartLineActivation  <i>RisingEdge</i> <i>FallingEdge</i> <i>AnyEdge</i>	Selects the activation mode of the input line trigger which starts the counter. This is only applicable when the counterStartSource feature selects a physical Line.  <i>Starts counting on rising edge of the selected Line.</i>  <i>Starts counting on falling edge of the selected Line.</i>  <i>Starts counting on the falling or rising edge of the selected Line.</i>	1.00 Expert DFNC



Counter Incremental Source	counterIncrementalSource	Select the event source which increments the counter. The <a href="#">Event Control section</a> provides details and timing diagrams for the supported events.	1.00 Expert DFNC
<i>Off</i>	<i>Off</i>	<i>Counter is stopped.</i>	
<i>Acquisition Start</i>	<i>AcquisitionStart</i>	<i>Counts the number of Acquisition Start events.</i>	
<i>Acquisition End</i>	<i>AcquisitionEnd</i>	<i>Counts the number of Acquisition End events.</i>	
<i>Exposure Start</i>	<i>ExposureStart</i>	<i>Counts the number of Exposure Start events.</i>	
<i>Exposure End</i>	<i>ExposureEnd</i>	<i>Counts the number of Exposure End events.</i>	
<i>Readout Start</i>	<i>ReadoutStart</i>	<i>Counts the number of Readout Start events.</i>	
<i>Readout End</i>	<i>ReadoutEnd</i>	<i>Counts the number of Readout End events.</i>	
<i>Frame Start</i>	<i>FrameStart</i>	<i>Counts the number of Frame Start events.</i>	
<i>Line 1</i>	<i>Line1</i>	<i>Counts the number of transitions on Line 1 (based on the counterIncrementalLineActivation feature setting) See Input Signals Electrical Specifications.</i>	
<i>Line 2</i>	<i>Line2</i>	<i>Counts the number of transitions on Line 2 (based on the counterIncrementalLineActivation feature setting)</i>	
<i>Line 3</i>	<i>Line3</i>	<i>Counts the number of transitions on Line 3 (based on the counterIncrementalLineActivation feature setting)</i>	
<i>Line 4</i>	<i>Line4</i>	<i>Counts the number of transitions on Line 4 (based on the counterIncrementalLineActivation feature setting)</i>	
<i>Rotary Encoder</i>	<i>rotaryEncoder1</i>	<i>The counter increments on rotary encoder ticks.</i>	
<i>Internal Clock</i>	<i>InternalClock</i>	<i>The counter increments on each microsecond tick of the device internal Clock.</i>	
<i>Timer 1 End</i>	<i>Timer1End</i>	<i>Counts the number of Timer 1 End events.</i>	
<i>Timer 2 End</i>	<i>Timer2End</i>	<i>Counts the number of Timer 2 End events.</i>	
Counter Incremental Line Activation	counterIncrementalLineActivation	Selects the counter signal activation mode for line inputs. The counter increments on the specified signal edge or level.	1.00 Expert DFNC
<i>Rising Edge</i>	<i>RisingEdge</i>	<i>Increment the counter on the rising edge of the selected I/O Line.</i>	
<i>Falling Edge</i>	<i>FallingEdge</i>	<i>Increment the counter on the falling edge of the selected I/O Line.</i>	
<i>Any Edge</i>	<i>AnyEdge</i>	<i>Increment the counter on the falling or rising edge of the selected I/O Line.</i>	
Counter Reset Source	counterResetSource	Selects the signal source to reset the counter then waits for the next countStartSource signal or event.	1.10 Expert DFNC
<i>Reset Cmd</i>	<i>Off</i>	<i>Reset on reception of the Reset command.</i>	
<i>Acquisition Start</i>	<i>AcquisitionStart</i>	<i>Reset on reception of the Acquisition Start.</i>	
<i>Acquisition End</i>	<i>AcquisitionEnd</i>	<i>Reset on reception of the Acquisition End.</i>	
<i>Exposure Start</i>	<i>ExposureStart</i>	<i>Reset on reception of the Exposure Start event.</i>	
<i>Exposure End</i>	<i>ExposureEnd</i>	<i>Reset on reception of the Exposure End event.</i>	
<i>Readout Start</i>	<i>ReadoutStart</i>	<i>Reset the counter on the reception of the Readout Start event.</i>	
<i>Readout End</i>	<i>ReadoutEnd</i>	<i>Reset the counter on the reception of the Readout End event.</i>	
<i>Frame Trigger</i>	<i>FrameStart</i>	<i>Reset on reception of the Frame Trigger.</i>	
<i>Line 1</i>	<i>Line1</i>	<i>Reset counter on the specified transition on line 1. See Input Signals Electrical Specifications.</i>	
<i>Line 2</i>	<i>Line2</i>	<i>Reset counter on the specified transition on line 2.</i>	
<i>Line 3</i>	<i>Line3</i>	<i>Reset counter on the specified transition on line 3.</i>	
<i>Line 4</i>	<i>Line4</i>	<i>Reset counter on the specified transition on line 4.</i>	
<i>Timer 1 End</i>	<i>Timer1End</i>	<i>Reset on reception of the Timer 1 End.</i>	

<i>Timer 2 End</i>	<i>Timer2End</i>	<i>Reset on reception of the Timer 2 End.</i>	
<i>Counter 1 End</i>	<i>Counter1End</i>	<i>Reset on the reception of the Counter 1 end.</i>	
<i>Counter 2 End</i>	<i>Counter2End</i>	<i>Reset on the reception of the Counter 2 end.</i>	
Counter Reset Input Line Activation  <i>Rising Edge</i> <i>Falling Edge</i> <i>Any Edge</i>	counterResetLineActivation  <i>RisingEdge</i> <i>FallingEdge</i> <i>AnyEdge</i>	Specify the edge transition on the selected line that will reset the selected counter.  <i>Reset counter on rising edge of the selected signal.</i> <i>Reset counter on falling edge of the selected signal.</i> <i>Reset counter on the falling or rising edge of the selected signal</i>	1.00 Expert DFNC
Counter Duration	counterDuration	Sets the duration (or number of events) before the CounterEnd event is generated.	1.00 Expert DFNC
Counter Value	counterValue	Read the current value of the selected counter. (RO)	1.00 Expert DFNC
Counter Value At Reset	counterValueAtReset	Reads the value of the selected counter when it was reset by a trigger or by an explicit Counter Reset command. (RO)	1.00 Expert DFNC
Counter Reset	counterReset	Resets the selected counter to zero. The counter starts immediately after the reset. To temporarily disable the counter, set the Counter Event Source feature to Off. (WO)	1.00 Expert DFNC
Timer Selector  <i>Timer 1</i> <i>Timer 2</i>	timerSelector  <i>Timer1</i> <i>Timer2</i>	Selects which timer to configure.  <i>Configure Timer 1</i> <i>Configure Timer 2</i>	1.00 Expert DFNC
Timer Mode  <i>Off</i> <i>Active</i>	timerMode  <i>Off</i> <i>Active</i>	Select the timer mode. The selected Timer is Active or Disabled. When Disabled, the Timer can be configured.  <i>The selected Timer is Disabled.</i> <i>The selected Timer is Enabled.</i>	1.00 Expert DFNC
Timer Status  <i>Timer Idle</i>  <i>Timer Trigger Wait</i> <i>Timer Delaying</i> <i>Timer Active</i> <i>Timer Completed</i>	timerStatus  <i>TimerIdle</i>  <i>TimerTriggerWait</i> <i>TimerDelaying</i> <i>TimerActive</i> <i>TimerCompleted</i>	Returns the current state of the timer. (RO)  <i>The timer is idle. The CounterStartSource feature is set to off.</i> <i>The timer is waiting for a start trigger.</i> <i>The timer is counting the requested delay.</i> <i>The timer is counting for the specified duration.</i> <i>The timer reached the TimerDuration count.</i>	1.00 Expert DFNC
Timer Start Source  <i>TimerReset Cmd</i>  <i>Acquisition Start</i> <i>Acquisition End</i> <i>Exposure Start</i> <i>Exposure End</i> <i>Readout Start</i> <i>Readout End</i> <i>Frame Start</i> <i>Line 1</i> <i>Line 2</i> <i>Line 3</i> <i>Line 4</i> <i>Timer 1 End</i>	timerStartSource  <i>Off</i>  <i>AcquisitionStart</i> <i>AcquisitionEnd</i> <i>ExposureStart</i> <i>ExposureEnd</i> <i>ReadoutStart</i> <i>ReadoutEnd</i> <i>FrameStart</i> <i>Line1</i> <i>Line2</i> <i>Line3</i> <i>Line4</i> <i>Timer1End</i>	Select the trigger source to start the timer. The <a href="#">Event Control</a> section provides details and timing diagrams for the supported events.  <i>Starts with the reception of the TimerReset command.</i> <i>Start Timer on Acquisition Start event.</i> <i>Start Timer on Acquisition End event.</i> <i>Start Timer on Exposure Start event.</i> <i>Start Timer on Exposure End event.</i> <i>Start Timer on Readout Start event.</i> <i>Start Timer on Readout End event.</i> <i>Start Timer on Frame Start event.</i> <i>Start Timer on a transition of I/O Line 1 event. See Input Signals Electrical Specifications.</i> <i>Start Timer on a transition of I/O Line 2 event.</i> <i>Start Timer on a transition of I/O Line 3 event.</i> <i>Start Timer on a transition of I/O Line 4 event.</i> <i>Start Timer on Timer 1 End event.</i>	1.00 Expert DFNC

Timer 2 End Counter 1 End Counter 2 End	Timer2End Counter1End Counter2End	Start Timer on Timer 2 End event. Start Timer on Counter 1 End event. Start Timer on Counter 2 End event.	
Timer Line Activation  Rising Edge Falling Edge  Any Edge	timerStartLineActivation  RisingEdge FallingEdge  AnyEdge	Select the trigger activation mode which starts the timer.  Starts counter on rising edge of the selected signal. Starts counter on falling edge of the selected signal.  Starts counter on the falling or rising edge of the selected signal.	1.00 Expert DFNC
Timer Delay	timerDelay	Sets the duration (in microseconds) of the delay to apply at the reception of a trigger before starting the timer.	1.00 Expert DFNC
Timer Duration	timerDuration	Sets the duration (in microseconds) of the timer pulse.	1.00 Expert DFNC
Timer Value	timerValue	Reads the current value (in microseconds) of the selected timer.	1.00 Expert DFNC
Timer Reset	timerReset	Resets the timer to 0.	1.00 Expert DFNC

## Counter and Timer Group Block Diagram

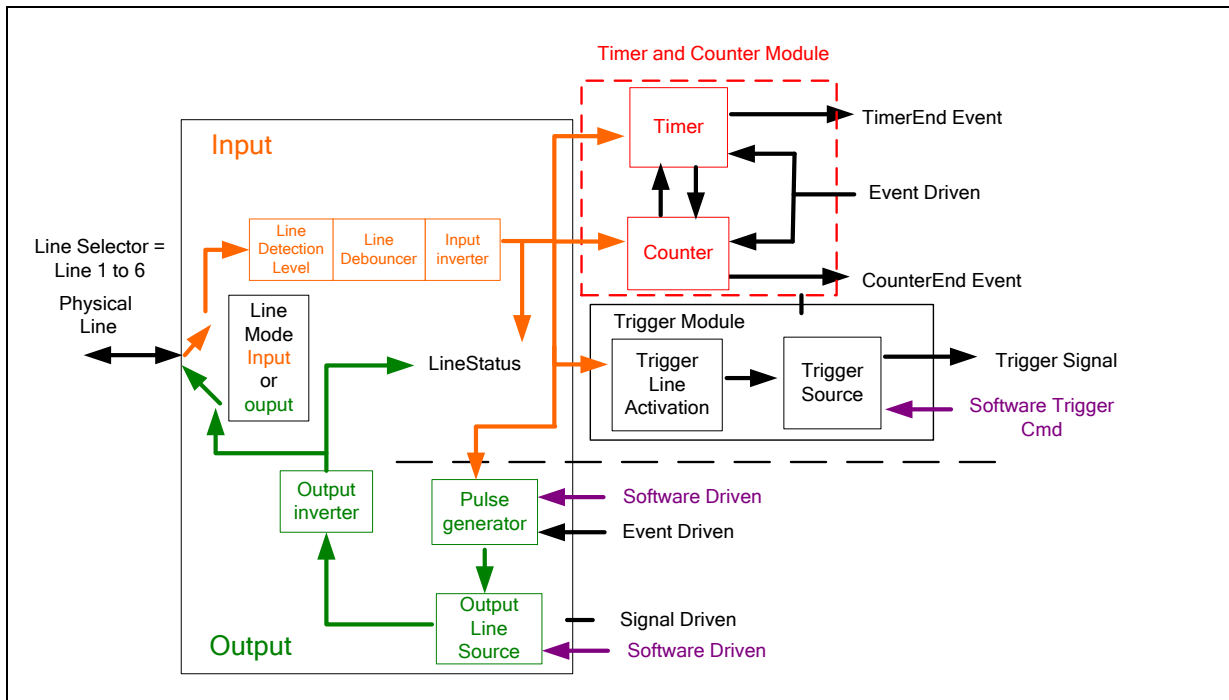

**Example: Counter Start Source = OFF**

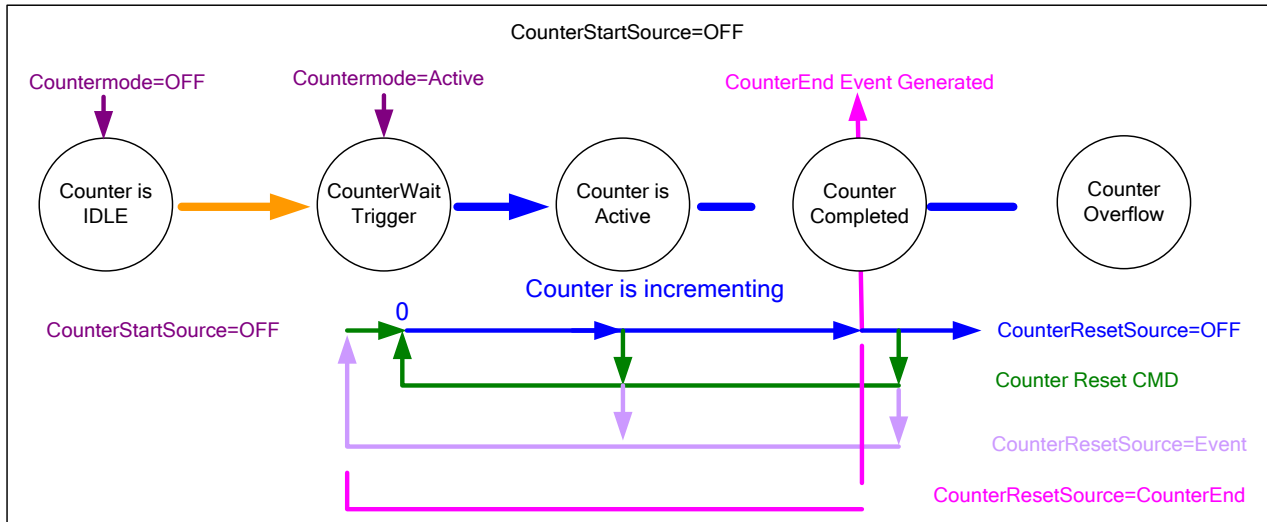

- The counter starts on the **counterReset Cmd**.
- The counter continues unless a new **counterReset Cmd** is received, which then restarts the counter at 00.
- When **Counter Reset Source= 'Event' or 'CounterEnd'** the counter is reset to 00 but does not restart counting, until the next **CounterReset Cmd**.

**Example: Counter Start Source = CounterEnd (itself)**

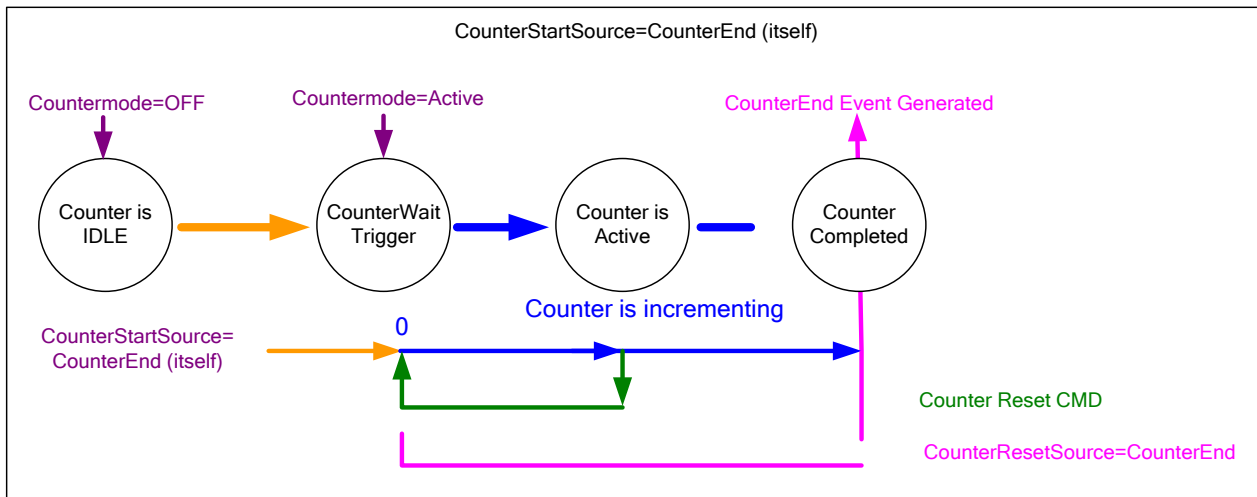

- Counter starts when Counter Mode is set to Active.
- A **Counter Reset CMD** will reset the counter to 00 and it then continues counting.
- **counterResetSource** must be set to **CounterEnd**. When the counterValue feature reaches the counterDuration value an event is generated and the counter is reset to 00, then continues.

**Example: CounterStartSource = EVENT and Signal (Edge Base)**

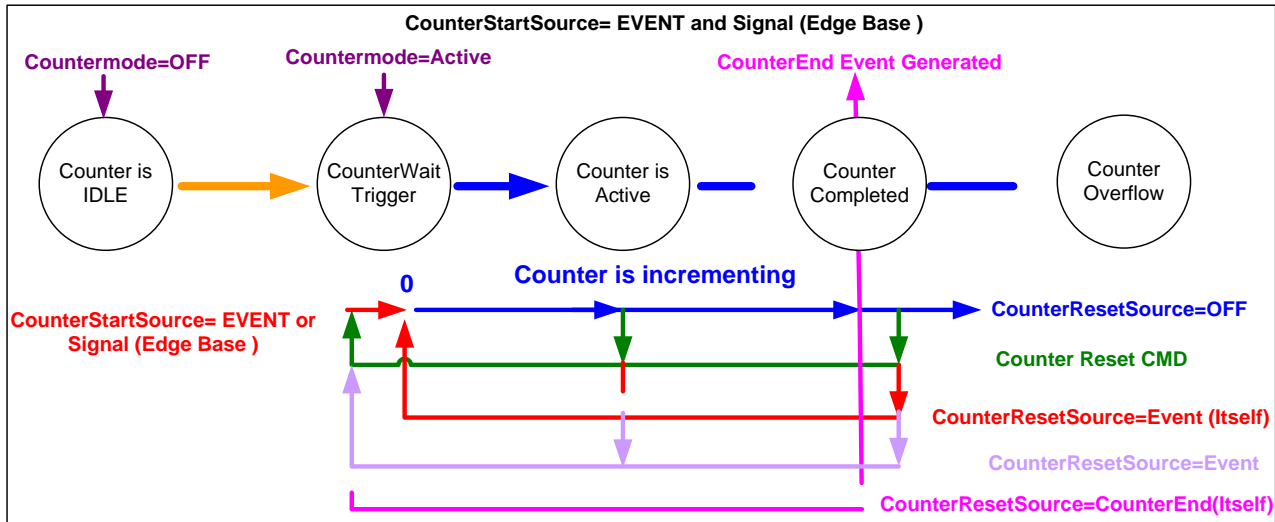

**Example: CounterStartSource = Signal (Level Base) Example 1**

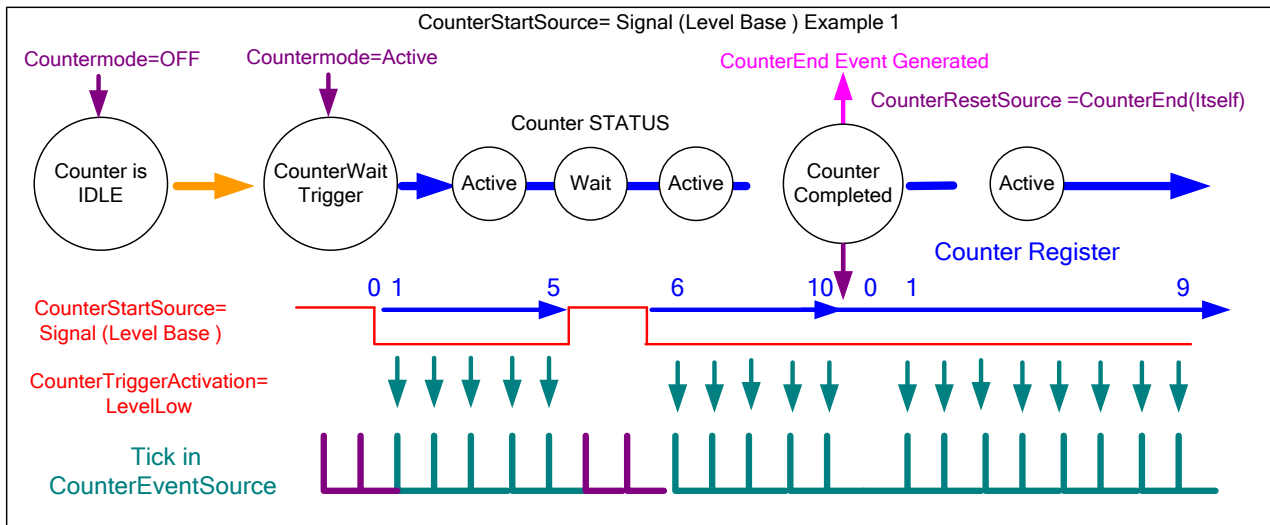

### Example: CounterStartSource = Line (Edge Base) Example 2

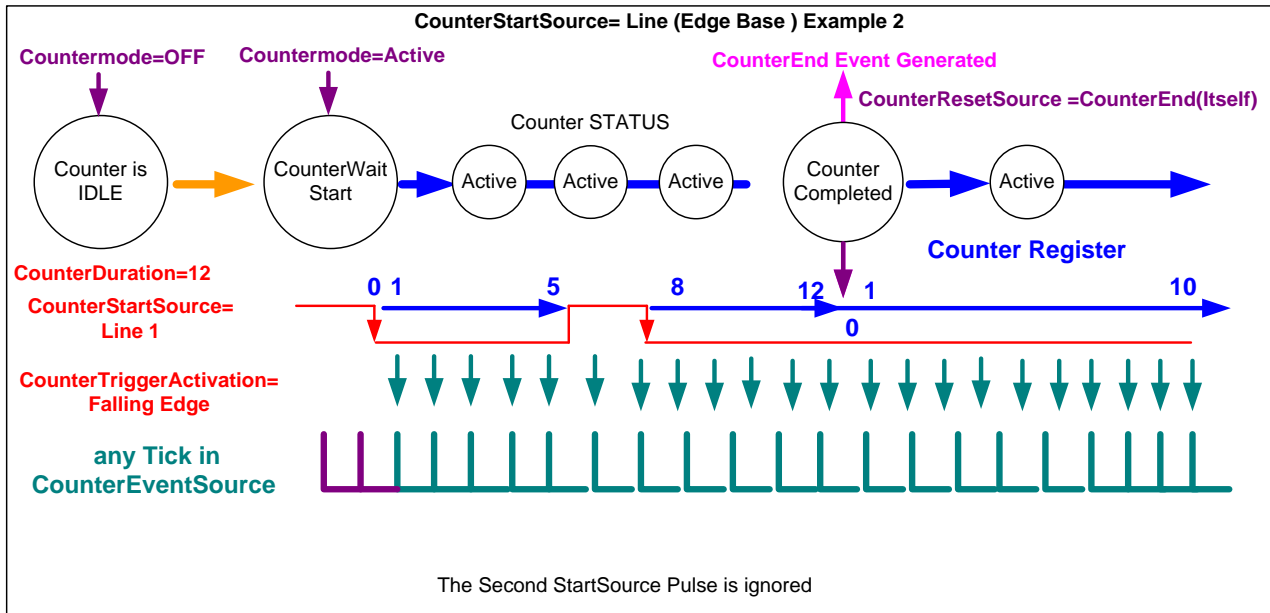

## Advanced Processing Control Category

The Linea GigE Advanced Processing controls, as shown by CamExpert, group parameters used to configure Flat Field calibration. Parameters in gray are read only, either always or due to another parameter being disabled. Parameters in black are user set in CamExpert or programmable via an imaging application.

Features listed in the description table but tagged as *Invisible* are usually for Teledyne DALSA or third party software usage—not typically needed by end user applications.

Parameters - Visibility: Guru		
Category	Parameter	Value
Camera Information	Flat Field Correction Mode	Off
Sensor Control	Flat Field Correction Current Active Set	Factory Flatfield
I/O Controls	Flat Field Correction Type	Line-Based
Counter And Timer Control	Flat Field Correction Algorithm	Method 1
<b>Advanced Processing</b>	Calibration Algorithm	Basic
Cycling Preset	Flat field Calibration Target (in DN)	64
Image Format Controls	Flat Field Calibration Sample Size	2048
Acquisition and Transfer Cont...	Flat Field Calibration Offset X	0
<b>Device Event Control</b>	Flat Field Calibration Width	4096
GigE Vision Transport Layer	Calibrate FPN	Not Enabled
File Access Control	Calibrate PRNU	Not Enabled
GigE Vision Host Controls	Save Calibration	Not Enabled
	Reset Coefficients	Press...
	Flat Field Correction Pixel X Coordinate	0
	Flat Field Correction Gain	1.0
	Flat Field Correction Offset	0
	Color Transformation Matrix Selector	NoCorrectionFactorySet
	<< Less	

## Advanced Processing Control Feature Descriptions

The following table describes these features along with their view attribute and device version. When a Device Version number is indicated, this represents the camera software functional group, not a firmware revision number. As Linea GigE capabilities evolve the device version will increase, therefore identifying the supported function package. New features for a major device version release will be indicated by green text for easy identification.

The description column will indicate which feature is a member of the DALSA Features Naming Convention (indicated by DFNC), versus the GenICam Standard Features Naming Convention (SFNC not shown).

Display Name	Feature & Values	Description	Device Version & View
<u>Flat Field Correction Mode</u> Off Active Calibration	flatfieldCorrectionMode Off Active Calibration	Sets the mode for the Flat Field correction. <i>Flat Field Correction is disabled.</i> <i>Flat Field Correction is enabled.</i> When selected, the camera is configured for flat field correction calibration. The device may automatically adjust some of its features when calibrate mode is enabled. The features that are automatically adjusted are device specific. The device will not restore these features when the Flat Field Correction Mode feature is changed from Calibrate mode to another mode.	1.00 Beginner DFNC
Flat Field Correction Current Active Set  Factory Flatfield User Flatfield 1 User Flatfield 2 User Flatfield 3 User Flatfield 4	flatfieldCorrectionCurrentActiveSet  FactoryFlatfield UserFlatfield1 UserFlatfield2 UserFlatfield3 UserFlatfield4	Specifies the current set of Flat Field coefficients to use. User data is uploaded via the file access feature. Feature used when flatfieldCorrectionMode is Active. In Calibration, changing this feature has no effect unless you save the FFC, where this feature defines where to save the values. This feature also can be used to copy FFC sets. Sets the factory Flat Field coefficient table as the current Flat Field. Sets User Flat Field 1 coefficient table as the current Flat Field. Sets User Flat Field 2 coefficient table as the current Flat Field. Sets User Flat Field 3 coefficient table as the current Flat Field. Sets User Flat Field 4 coefficient table as the current Flat Field.	1.00 Beginner DFNC
Flat Field Correction Type Line-Based	flatfieldCorrectionType LineBase	Specifies the Flat Field correction type. Flat field correction is based on an individual line (FlatLine).	1.00 Guru DFNC
<u>Flat Field Correction Algorithm</u> Method 1	flatfieldCorrectionAlgorithm Method1	Specifies the Flat Field correction algorithm to use. The following formula is used to calculate the flat field corrected pixel: $newPixelValue[x] = (sensorPixelValue[x] - FFCOffset[x]) * FFCGain[x]$	1.00 Guru DFNC
Calibration Algorithm Basic Low Pass Filter	flatfieldCorrectionCalibrationAlgorithm Basic LowPass	Specifies the flatfield calibration algorithm to use. Direct calculation of coefficients based on average line values and target. Apply a low pass filter to average line prior to calculating coefficients. Used when target is not uniformly white or it is not possible to defocus image.	1.00 Guru DFNC
Flat Field Calibration Target	flatfieldCalibrationTarget	Sets the target pixel value for the gain (PRNU) calibration.	1.00 Guru DFNC
Flat Field Calibration Sample Size 2048 4096	flatfieldCalibrationSampleSize Lines_2048 Lines_4096	Set flat field calibration sample size (number of lines to sum) 2048 4096	1.00 Guru DFNC
Flat Field Calibration Offset X	flatfieldCalibrationROIOffsetX	Sets the ROI Offset X	1.00 Guru DFNC
Flat Field Calibration Width	flatfieldCalibrationROIWidth	Sets the ROI Width	1.00 Guru DFNC



Calibrate FPN	flatfieldCalibrationFPN	Performs Fixed Pattern Noise (FPN) calibration by reducing to zero dark pixel current using a pixel offset.	1.00 Guru DFNC
<i>No Error</i>	<i>NoError</i>	<i>No Error</i>	
<i>Calibration Failed</i>	<i>GenericError</i>	<i>FPN calibration failed.</i>	
<i>Camera Busy</i>	<i>BusyError</i>	<i>The camera is busy and cannot perform the FPN calibration.</i>	
<i>Timeout Error</i>	<i>TimeoutError</i>	<i>The FPN calibration did not finished on time.</i>	
<i>Memory Error</i>	<i>MemoryError</i>	<i>The camera cannot allocate the memory needed for FPN calibration.</i>	
<i>Target Error</i>	<i>TargetError</i>	<i>The FPN calibration was not able to reach the targets.</i>	
Calibrate PRNU	flatfieldCalibrationPRNU	Performs Photo Response Non Uniformity (PRNU) calibration to a targeted, user-defined value. PRNU calibration eliminates the difference in responsivity between the most and least sensitive pixel, creating a uniform response to light.	1.00 Guru DFNC
<i>No Error</i>	<i>NoError</i>	<i>No Error</i>	
<i>Calibration Failed</i>	<i>GenericError</i>	<i>FPN calibration failed.</i>	
<i>Camera Busy</i>	<i>BusyError</i>	<i>The camera is busy and cannot perform the FPN calibration.</i>	
<i>Timeout Error</i>	<i>TimeoutError</i>	<i>The FPN calibration did not finished on time.</i>	
<i>Memory Error</i>	<i>MemoryError</i>	<i>The camera cannot allocate the memory needed for FPN calibration.</i>	
<i>Target Error</i>	<i>TargetError</i>	<i>The PRNU calibration was not able to reach the targets.</i>	
Save Calibration	flatfieldCalibrationSave	Save the calibration performed by flatfieldCalibrationFPN and flatfieldCalibrationPRNU to the active set.	1.00 Guru DFNC
Reset Coefficients	flatfieldResetCoefficients	Reset all FFC coefficients to pass-through.	1.00 Guru DFNC
Flat Field Correction Pixel X Coordinate	flatfieldCorrectionPixelXCoordinate	Specifies the X coordinate of the flat field pixel coefficient to access.	1.00 Guru DFNC
Flat Field Correction Gain	flatfieldCorrectionGain	Sets the gain to apply to the currently selected pixel.	1.00 Guru DFNC
Flat Field Correction Offset	flatfieldCorrectionOffset	Sets the offset to apply to the currently selected pixel.	1.00 Guru DFNC
Color Transformation Matrix Selector	colorTransformationSelector	Selects the number of transformation matrix.	1.00 Guru DFNC
<i>No Correction Factory Set</i>	<i>NoCorrectionFactorySet</i>	<i>No correction, factory set.</i>	
<i>White LED Factory Set</i>	<i>WhiteLEDFactorySet</i>	<i>White LED, factory set.</i>	
<i>Matrix User Set1</i>	<i>MatrixUserSet1</i>	<i>Color matrix, user set 1.</i>	
<i>Matrix Users Set2</i>	<i>MatrixUsersSet2</i>	<i>Color matrix, user set 2.</i>	
LUT Mode	lutMode	Sets the enable state of the selected LUT (Lookup Table).	1.00 Expert DFNC
<i>Off</i>	<i>Off</i>	<i>Disables the LUT.</i>	
<i>Active</i>	<i>Active</i>	<i>Enables the selected LUT.</i>	
LUT Type	lutType	Displays the LUT type of the currently selected Lookup Table.	1.00 Expert DFNC
<i>User Defined</i>	<i>UserDefined</i>	<i>Uses the user programmable LUT.</i>	

LUT Current Active Set  <i>LUT Set 1 to LUT Set 8</i>	lutCurrentActiveSet  <i>LUT_Set_1 to LUT_Set_8</i>	Specifies the current LUT to use.	1.00 Expert DFNC
LUT Selector  <i>Luminance</i>	LUTSelector  <i>Luminance</i>	Selects which LUT to control and adjust features.  <i>Luminance is under control.</i>	1.00 Guru
LUT Size  <i>12 Bits/Pixel</i>	lutSize  <i>Bpp12</i>	Specify the LUT size of the selected LUT (Lookup Table).  <i>12 bits per pixel</i>	1.00 Expert DFNC
White Balance ROI Mode  <i>Off</i>  <i>Active</i>	balanceWhiteROIMode  <i>Off</i>  <i>Active</i>	When active, the White Balance algorithm limits analysis to the ROI image area to determine the white balance adjustments.  <i>All of the output image is used in the White Balance algorithm.</i>  <i>The selected ROI is used in the White Balance algorithm.</i>	1.00 Expert DFNC
White Balance On-Demand Cmd	balanceWhiteAutoOnDemandCmd	Executes the automatic white balance function. The first frame acquired is used to calculate the RGB gain adjustments, which are then applied to subsequent snaps or grabs. (WO)	1.00 Expert DFNC
White Balance ROI Offset X	balanceWhiteROIOffsetX	Specifies the offset x, in pixels, of the white balance processing ROI.	1.00 Beginner DFNC
White Balance ROI Width	balanceWhiteROIWidth	Specifies the width, in pixels, of the white balance processing ROI.	1.00 Beginner DFNC
imageFilterMode  <i>Off</i>  <i>Active</i>	imageFilterMode  <i>Off</i>  <i>Active</i>	Enable the image filter corrections with a predefined digit filter algorithm  <i>Disables image filter corrections.</i>  <i>Enables image filter corrections.</i>	1.00 Guru DFNC
Image Filter Type  <i>Weighted Average</i>	imageFilterType  <i>Weighted_Average</i>	Selects the type of image filter to use.  <i>Weighted Average Algorithm</i>	1.00 Guru DFNC
Image Filter Kernel Size  <i>Kernel 1x3</i>  <i>Kernel 1x5</i>	imageFilterKernelSize  <i>KERNEL_1x3</i>  <i>KERNEL_1x5</i>	Sets the image filter kernel size	1.00 Guru DFNC
Image Filter Contrast Ratio	imageFilterContrastRatio	Set image filter contrast ratio threshold	1.00 Guru DFNC

## Flat Field Correction Overview

The Flat Field correction function (FFC) consists of using two coefficients per pixel which correct the gain and offset of the corresponding pixel. These corrections compensate for Photo-response Non-uniformity (PRNU) and Fix Pattern noise (FPN), unique to each camera sensor.

With CMOS sensors, it is imperative to perform FFC calibration under the same conditions the camera is to be used in. The exposure time and camera internal temperature need to be similar to the expected operating conditions, else CMOS sensor variations (over temperature and exposure) will render the FFC calibration invalid. Linea GigE cameras have multiple FFC user memory spaces to store calibration data, allowing users to store FFC data for different optimized exposure setups.

The following diagram illustrates the camera's digital processing chain and associated GeniCam features.

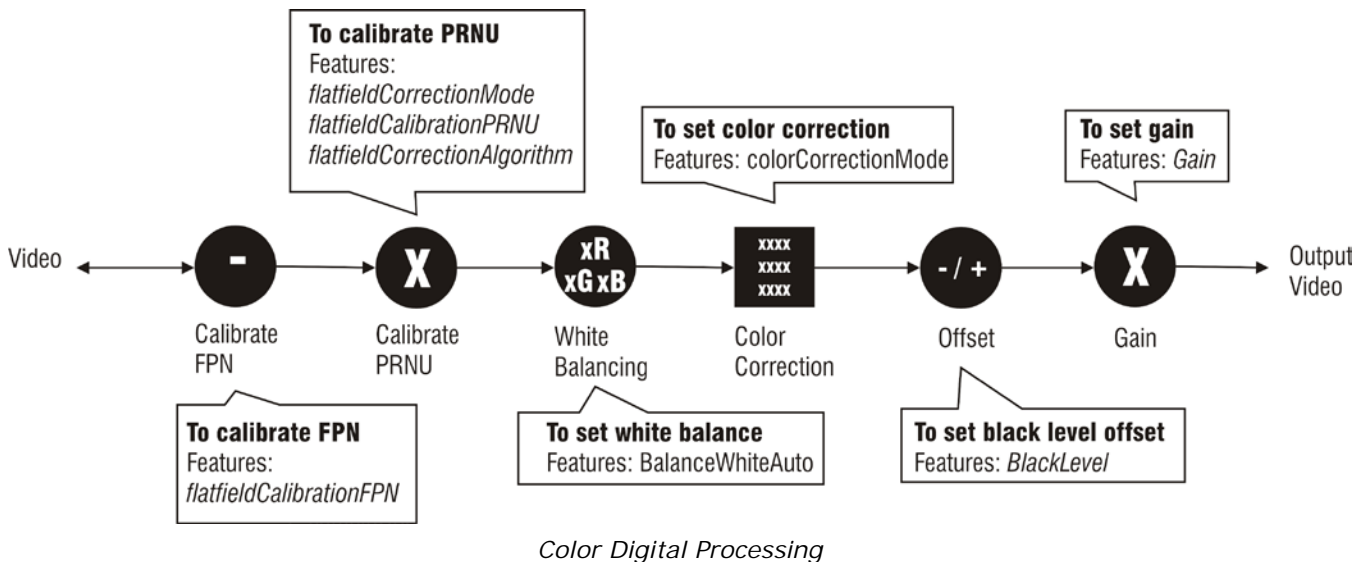

### Flat Field Correction Algorithm Description

Flat Field Correction Algorithm–Method1 (feature: flatfieldCorrectionAlgorithm) applies the following FFC formula for correcting pixel values.

$$\text{newPixelValue}[x] = (\text{sensorPixelValue}[x] - \text{FFCOffset}[x]) * \text{FFCGain}[x]$$

where:

- **[x]** is the Flat Field Correction Pixel coordinate.  
See the *FlatfieldCorrectionPixelXCoordinate* features.
- **newPixelValue** is the pixel value after Flat Field Correction is applied.
- **sensorPixelValue** is the pixel value before Flat Field correction is applied.
- **FFCOffset** is the offset coefficient value to subtract from the sensorPixelValue.
- **FFCGain** is the gain coefficient value that is multiplied with the sensorPixelValue.

**Important:** FFCOffset and FFCGain are derived factors calculated from a number of camera specific feature values (Invisible DFNC features). Reading these values directly from the Flat Field Coefficients file will be meaningless to the user.

### Information on the Spera Flat Field Coefficients File

The Flat Field Coefficients File is a standard 16-bit TIFF file.

A Sopera application (such as CamExpert) creates a new SapBuffer object of the same width as the sensor but with twice the number of lines. This provides the room to store both offset and gain Flat Field data. The Flat Field offset data is contained in the top half of the new buffer, while the gain buffer is in the bottom half.

A Sopera application saves the new buffer using SapBuffer::Save with the "-format tiff" option, which allows saving data without loss of significant bits.

### ***Important Factors about Flat Field Processing***



**Important:** Before calibration, the Linea GigE should be powered on long enough to achieve its nominal temperature (a minimum of 30 minutes). A low ambient temperature may increase the time required for the camera to reach a stable internal temperature.

**Important:** During calibration, no other Linea GigE features should be accessed or modified.

**Calibration via CamExpert or via a User Application:** Exposure and frame rates used during a Flat Field Calibration should be similar to the exposure settings used in the camera application.

## How to do a FFC Setup via Sopera CamExpert

The Sopera LT CamExpert tool provides an easy GUI based method for a user to perform a Flat Field Calibration. The process first requires the user to plan acquisitions in dark and bright conditions, followed by the FFC process itself. These steps are detailed below.

### Set up Dark and Bright Acquisitions with the Histogram Tool

Before performing calibration, verify Linea GigE acquisition with a live grab. Also at this time make preparations to grab a flat light gray level image, required for the calibration, such as a clean evenly lighted white wall or non-glossy paper with the lens slightly out of focus. Ideally a controlled diffused light source aimed directly at the lens should be used. Note the lens iris position for a bright but not saturated image. Additionally check that the lens iris closes well and have a lens cover to grab the dark calibration image.

### Verify a Dark Acquisition

Close the camera lens iris and cover the lens with a lens cap. Using CamExpert, click on the grab button and then the histogram button. The following figure shows a typical histogram for a Linea GigE grabbing a dark image.

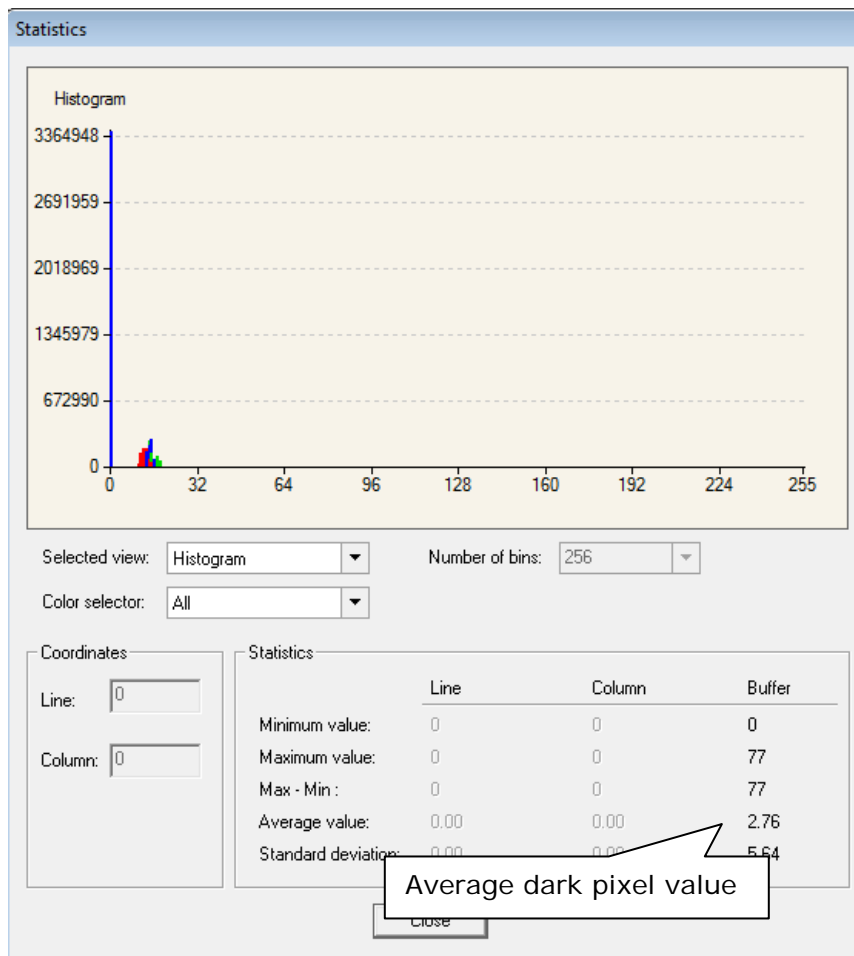

**Important:** In this example, the **average** pixel value for the frame is close to black. Also note that sensors might show a much higher maximum pixel value due to one or more "hot pixels".

## Verify a Bright Acquisition

Aim the camera at a diffused light source or evenly lit white wall with no shadows falling on it. Using CamExpert, click on the grab button and then the histogram button. Use the lens iris to adjust for a bright gray approximately around a pixel value of 200 (for 8-bit pixels). The following figure shows a typical histogram for a Linea GigE grabbing a bright gray image.

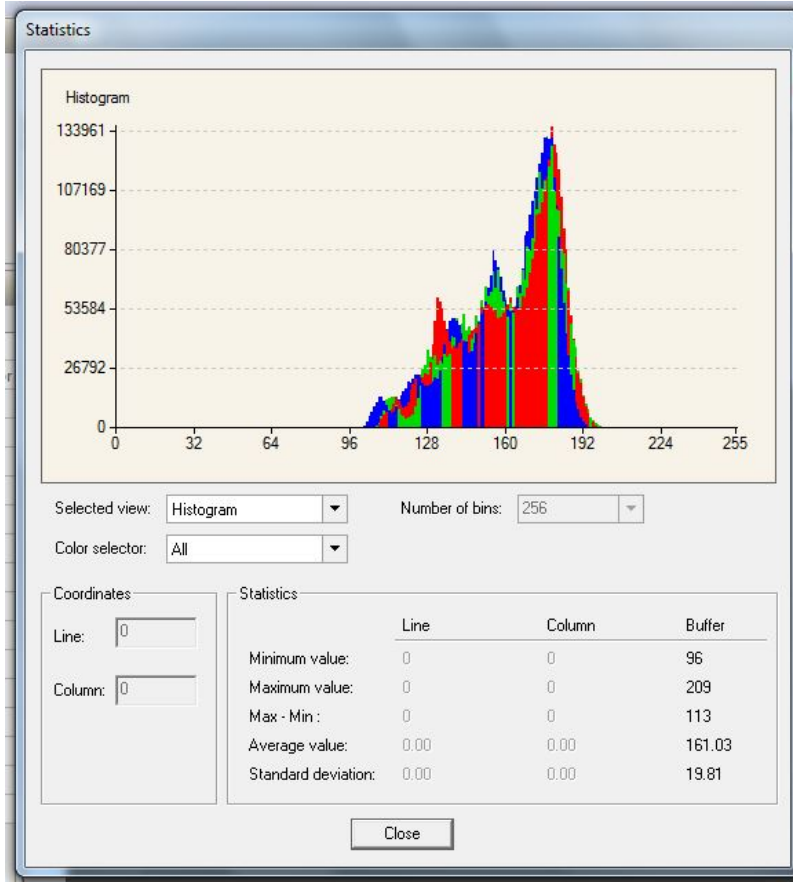

**Important:** In this example, the **average** pixel value for the frame is bright gray. Also note that sensors may show a much higher maximum or a much lower minimum pixel value due to one or more "hot or dead pixels". The sensor specification accounts for a small number of hot, stuck, or dead pixels (pixels that do not react to light over the full dynamic range specified for that sensor).

Once the bright gray acquisition setup is done, note the camera position and lens iris position so as to be able to repeat it during the calibration procedure.

## Flat Field Correction Calibration Procedure

The camera calibration contains operations such as FPN (Fixed Pattern Noise) correction, PRNU (Photon Response Non-uniformity) correction, color correction, etc. The most commonly used operations are FPN and PRNU corrections. Together they are called Flat Field Correction (FFC).

The goal of camera calibration is to produce a uniform, white balanced, and, if required, color corrected image at the desired level while imaging a uniform white object along with the user's application setup.

The FFC functions are grouped in the **Advanced Processing** category. For color correction, you can use the tool provided by CamExpert. For more information, contact your local TCS (technical customer support).

Category	Parameter	Value
Camera Information	Flat Field Correction Mode	Calibration
Sensor Control	Flat Field Correction Current Active Set	User Flatfield 1
I/O Controls	Flat Field Correction Type	Line-Based
Counter And Timer Control	Flat Field Correction Algorithm	Method 1
<b>Advanced Processing</b>	Calibration Algorithm	Basic
Color Processing	Flat field Calibration Target (in DN)	200
Cycling Preset	Flat Field Calibration Sample Size	4096
Image Format Controls	Flat Field Calibration Offset X	0
Acquisition and Transfer Cont...	Flat Field Calibration Width	4096
<b>Device Event Control</b>	Calibrate FPN	Press...
GigE Vision Transport Layer	Calibrate PRNU	Press...
File Access Control	Save Calibration	Press...
GigE Vision Host Controls	Reset Coefficients	Press...
	Flat Field Correction Pixel X Coordinate	0
	Flat Field Correction Gain	1.0
	Flat Field Correction Offset	5

Before performing a FFC, we strongly recommend that you evaluate the “bare image” characteristics. The bare image quality determines the quality of FFC that will be applied to the image.

To obtain a bare image, disable FPN, PRNU, and color correction coefficients, set white balance, red, green, and blue gains to 1x, and set the system gain to 1x.

1. Disable color correction coefficients by selecting *NoCorrectionFactorySet* in the option of *Color Transformation Matrix Selector* under the *Advanced Processing* category.

Color Transformation Matrix Selector	NoCorrectionFactorySet
LUT Mode	NoCorrectionFactorySet
LUT Type	WhiteLEDFactorySet
LUT Current Active Set	MatrixUserSet1
	MatrixUserSet2

2. Set red, green, and blue gains to 1x. Select the four options one-by-one in the *Gain Selector*, under the *Sensor Control* category.

Gain Selector	Digital All
Gain	Digital All
Black Level Selector	Digital Red
	Digital Green
Black Level	Digital Blue

Type or use the numeric up-down control to set the value to 1. The *Digital All* option represents the system gain.

Gain Selector	Digital Red
Gain	1.0

3. Choose *Off* from the Flat Field Correction Mode.

Parameters - Visibility: Guru		
Category	Parameter	Value
Camera Information	Flat Field Correction Mode	Off
Sensor Control	Flat Field Correction Current Active Set	Off
I/O Controls	Flat Field Correction Type	Active
Counter And Timer Control	Flat Field Correction Algorithm	Calibration
⊕ <b>Advanced Processing</b>	Calibration Algorithm	Method I
	Flat field Calibration Target (in DN)	Basic
		200

The camera is now ready to produce bare images. The line profile tool is best used to evaluate a bare image.

The following is an example line profile of a bare image of a white uniform object:



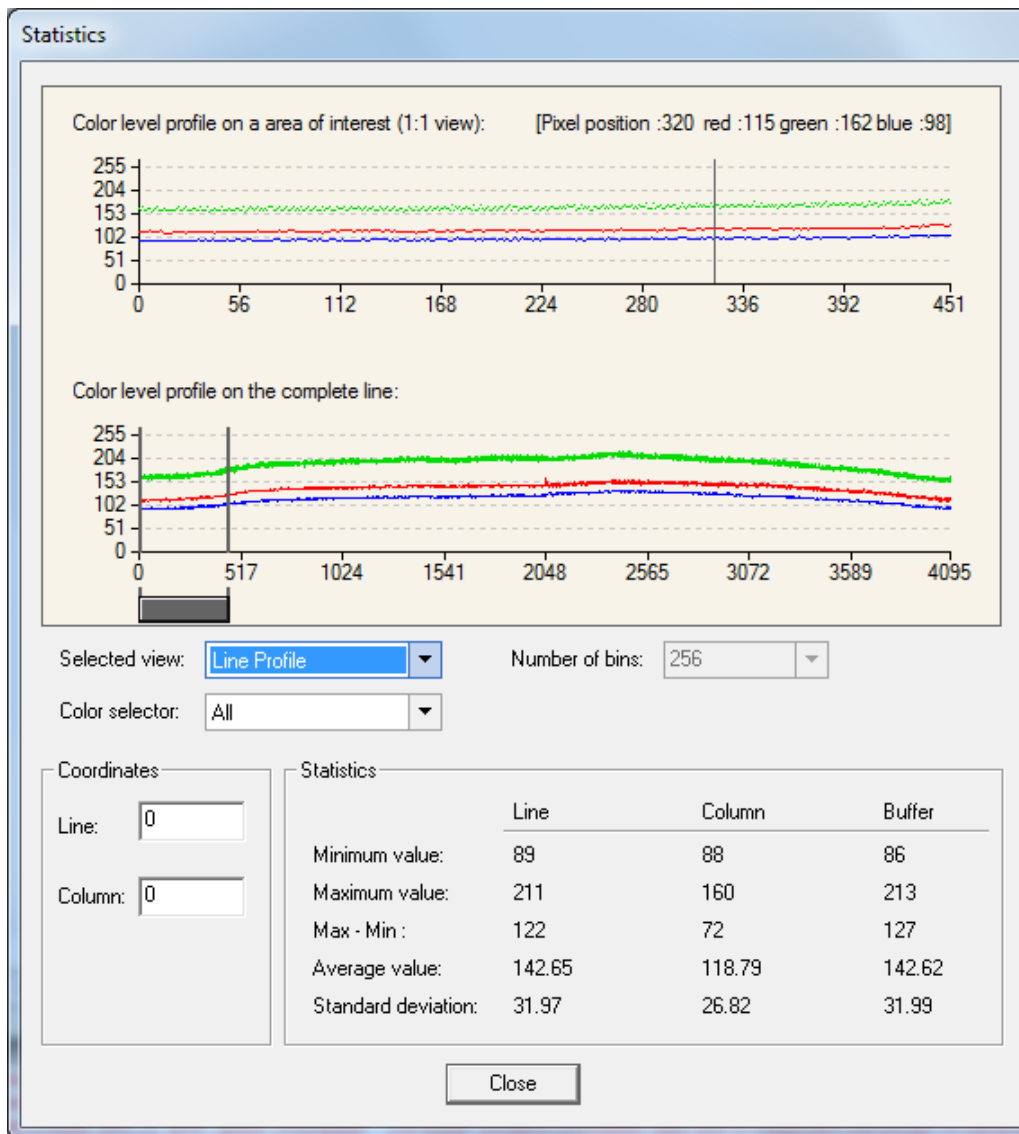

Figure 6. A good line profile of the bare image of a white and uniform object.

Whether a line profile is good or not is mainly determined by three factors:

1. Flatness
2. Height
3. Matching

**1) Flatness:** As line profiles represent a flat field in this case, the flatter the better it is. However, due to the lens-shading effect, the light falls-off towards the edges and results in edges output lower than the central area output. This leads to the edges' noise level being higher than the central area within FFC applied images. A smaller aperture opening and longer focal length can reduce the lens-shading effect. In some demanding applications, optimized low-shading lenses should be considered.

**2) Height:** The closer the average output level is to your calibration target the better. It is okay if the level is higher than the target, but it is not desirable to be much lower than the target.

Compared to the target, an extremely low output will increase the noise level significantly high after the PRNU is corrected such that the SNR and/or DNR may not meet your application's requirements. To avoid this, the profile should reach a level as near the calibration target as possible.

In order to adjust the profile height the exposure time, light intensity, diaphragm opening (which may conflict with the flatness), and lens throughput index, etc. are all factors that need to be considered. The purpose of all these is to enhance the illumination, after all.

**3) Matching:** The closer the three RGB line profiles are to each other the better. A large separation between the colors indicates varying noise level between colors. In theory, it is best if all three profiles match each other. In practice, however, it is not necessary that they overlap completely, only that you try to get them as close together as possible.

Light in different wavelength ranges can affect the degree of matching. Therefore, the filters being used in your applications need to be considered.

If, despite the above effort, you still do not meet your goals, it's time to use the gain features. You may want to use the white balance gains to adjust the peak of each color to a similar DN value, and use the system gain to adjust the peak intensity of the three colors to the desired DN level.

Keep in mind that changes to gain do not improve the image quality at all from an SNR perspective. All gains are digital multipliers and, as such, the gain scales up signal and noise proportionally. Therefore, use this method only as long as the SNR meets your application requirements.

In conclusion, before you perform the FFC, we recommend that you to try to improve the bare image quality first. Increasing the output level by enhancing illumination is the preferred method. You can do this by adjusting gains in the SNR allowable range.

Note that the line profile shown in the above figure is acceptable.

Keep the following in mind:

1. Ensure that camera's temperature is in a stable condition. This may require 30 or more minutes after power-on.
2. All parameters should meet your application's specifications. If you change parameters after the FFC is done, then the FFC results may no longer be relevant. When parameters change, you should consider rerunning the FFC.

The followings are the basic and typical steps to run an FFC:

### ***FPN Correction***

In general, you can skip the FPN correction as the camera's factory correction is good enough.

**Step 1.** Cover the lens (place the sensor in dark).

**Step 2.** Select *Off* from the Flat Field Correction Mode drop-down menu and check the line profile / histogram. If some, or all, of the pixels outputs are zero, then you should adjust the black level offset value so to ensure that all pixels' output are above zero. The black level offset adjustment is located in the *Sensor Control* category.

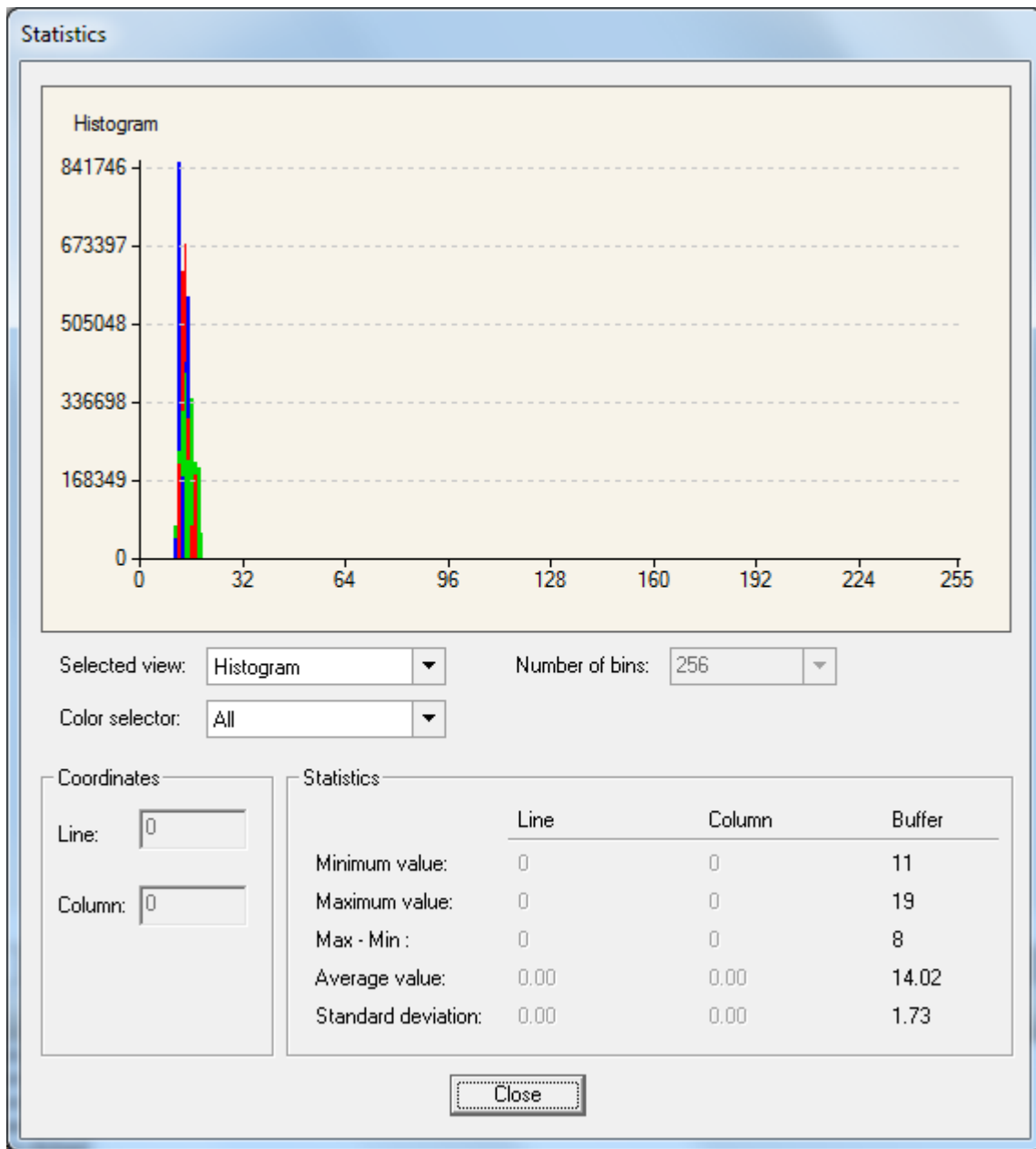

Figure 7 A histogram of a dark bare image.

**Step 3.** Select *Calibration* from Flat Field Correction Mode drop-down menu.

Category	Parameter	Value
Camera Information	Flat Field Correction Mode	Off
	Flat Field Correction Current Active Set	Off
Sensor Control	Flat Field Correction Type	Active
	Flat Field Correction Algorithm	Method 1
I/O Controls	Calibration Algorithm	Basic
	Flat field Calibration Target (in DN)	200
Counter And Timer Control		
Advanced Processing		

**Step 4.** Select 4096 or 2048 from Flat Field Calibration Sample Size. The 4096 option returns more accurate result; whereas, the 2048 option reduces calculating time. In general, the 2048 returns are still good enough.

**Step 5.** Press the *Press...* command in the Calibrate FPN menu. (The screenshot below refers to the following PRNU Correction steps).

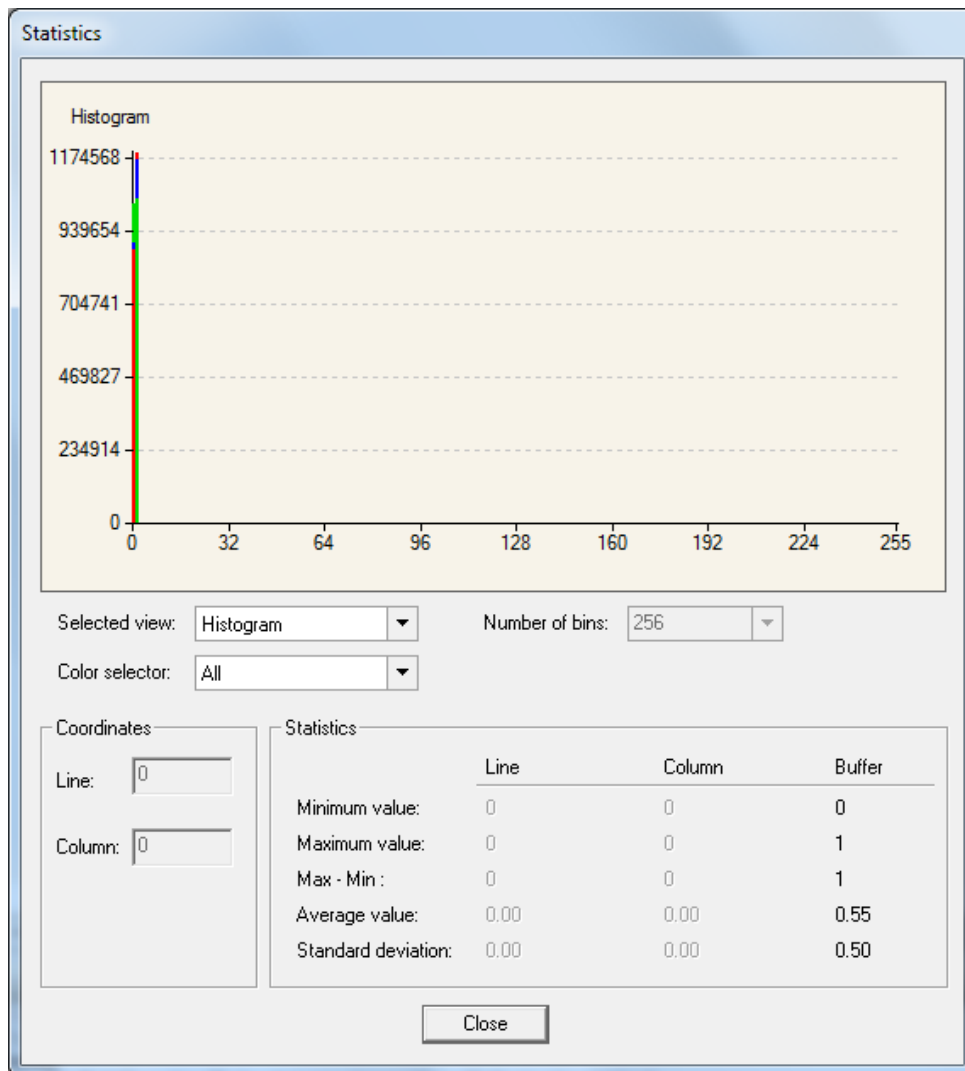

Figure 8 A histogram of a dark image after FPN has calibrated.

## PRNU Correction

**Step 1.** Apply illumination and place a white flat target in the spot where the real object will be. Ideally, you would use a professional target. For convenience you can use white paper as the target. However, the result of using paper may be the so-called grain effect—where visible vertical lines show up in grabbed images.

There are two common ways to correct the grain effect: 1) keep the object moving while the PRNU correction is performed. 2) Defocus the lens while the PRNU correction is performing and refocus once it has completed.

Select *Off* from the Flat Field Correction Mode drop-down menu and check the bare image line profile. We'll use the Figure above as an example and assume that it's acceptable.

**Step 2.** Select *Calibration* from Flat Field Correction Mode drop-down menu.

**Step 3.** Select *Basic* (in general, otherwise select *Low Pass Filter*) from Calibration Algorithm drop-down menu.

**Step 4.** Adjust the calibration target in the Flat Field Calibration Target (in DN) if necessary. 200 DN is a commonly used typical target. This target value can be higher or lower than the peak values you observe from the bare image.

**Step 5.** Select *4096* or *2048* from Flat Field Calibration Sample Size drop-down menu.

**Step 6.** Press the *Press...* command in Calibrate PRNU menu.

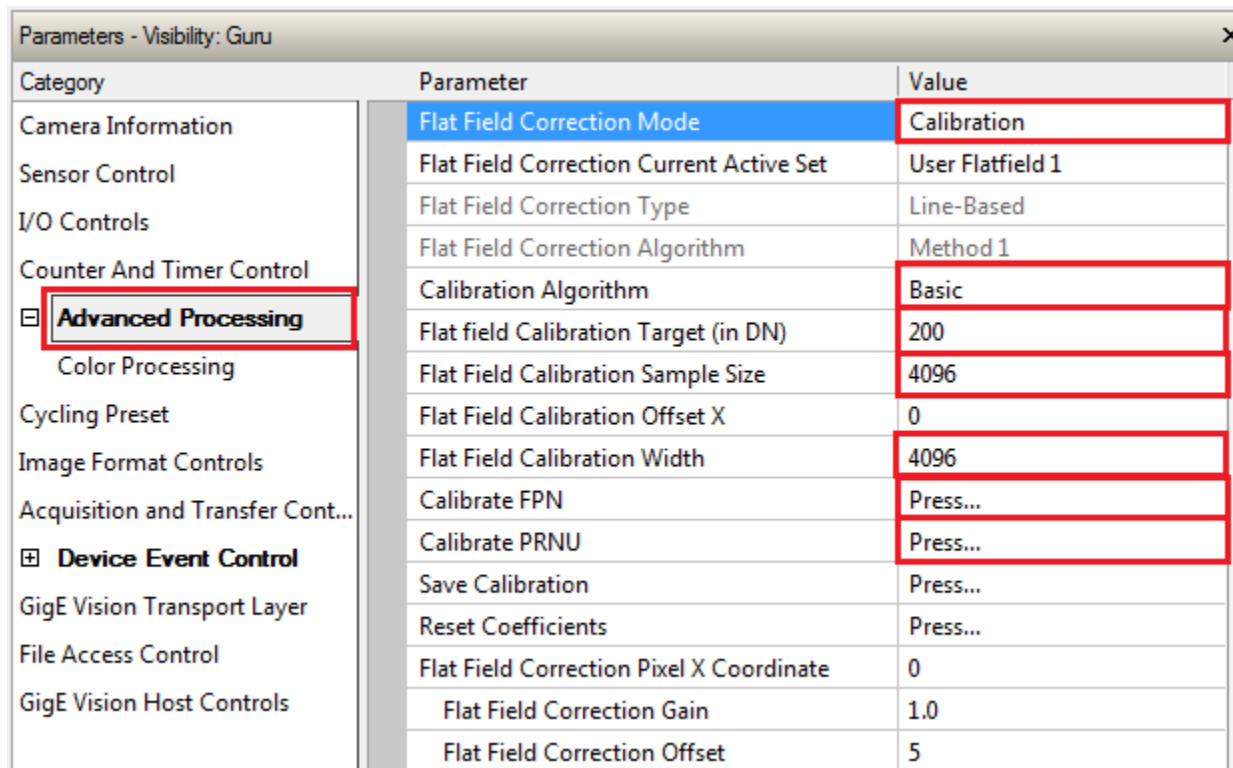

Category	Parameter	Value
Camera Information	Flat Field Correction Mode	Calibration
Sensor Control	Flat Field Correction Current Active Set	User Flatfield 1
I/O Controls	Flat Field Correction Type	Line-Based
Counter And Timer Control	Flat Field Correction Algorithm	Method 1
<input checked="" type="checkbox"/> <b>Advanced Processing</b>	Calibration Algorithm	Basic
Color Processing	Flat field Calibration Target (in DN)	200
Cycling Preset	Flat Field Calibration Sample Size	4096
Image Format Controls	Flat Field Calibration Offset X	0
Acquisition and Transfer Cont...	Flat Field Calibration Width	4096
<input checked="" type="checkbox"/> <b>Device Event Control</b>	Calibrate FPN	Press...
GigE Vision Transport Layer	Calibrate PRNU	Press...
File Access Control	Save Calibration	Press...
GigE Vision Host Controls	Reset Coefficients	Press...
	Flat Field Correction Pixel X Coordinate	0
	Flat Field Correction Gain	1.0
	Flat Field Correction Offset	5

**Step 7.** Select *Active* from *Flat Field Correction Mode* drop-down menu to apply the calibrated FPN and PRNU parameters to future imaging. You can check the results with the line profile.

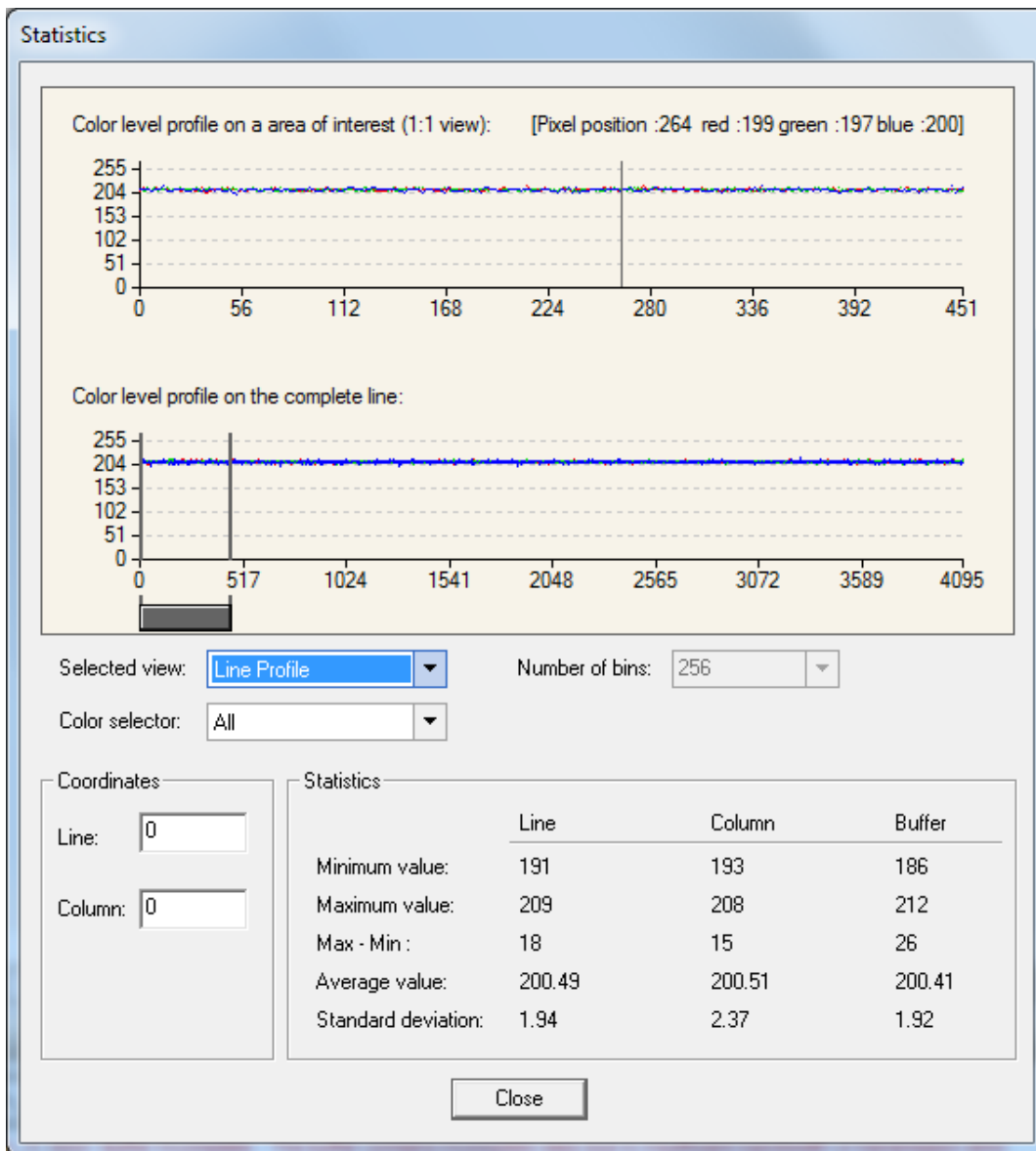

Figure 9 A line profile of a white uniform target after PRNU is calibrated.

As you can see above, the PRNU corrective function performed not only flat field correction but also white balance.

**Step 8.** You may want to save the FFC results for future use. If you do not save, the FFC result will be lost as soon as the camera loses power. Click *Setting...* in *Camera Information* category, *Power-up Configuration* parameter.

Category	Parameter	Value
Camera Information	Manufacturer Name	Teledyne DALSA
	Model Name	Linea C4096-7um
	Manufacturer part number	LA-GC-04K05B-00-R
	Device Version	1.01
	Manufacturer Info	Standard Design
	Firmware Version	3CA16.0032
	Serial Number	12070926
	MAC Address	00:01:0D:C2:4C:25
	Device User ID	
	Power-up Configuration Selector	UserSet 1
	Device Built-In Self Test	Press...
	Device Built-In Self Test Status	Passed
	Device Built-In Self Test Status All	0
	Sensor Error Status	OK
	Device Reset	Press...
	Device Temperature Selector	Camera Temperature
	Device Temperature	34.0
	overheatedStatus	OK
	Power-up Configuration	Setting...
	<< Less	

In the *Power-up Configuration* dialog box select one of four *UserSets* for both *Camera Power-up configuration* and *Load / Save configuration*, and press the *Save* button.

This will ensure that the camera loads the saved parameters the next time the camera is turned on.

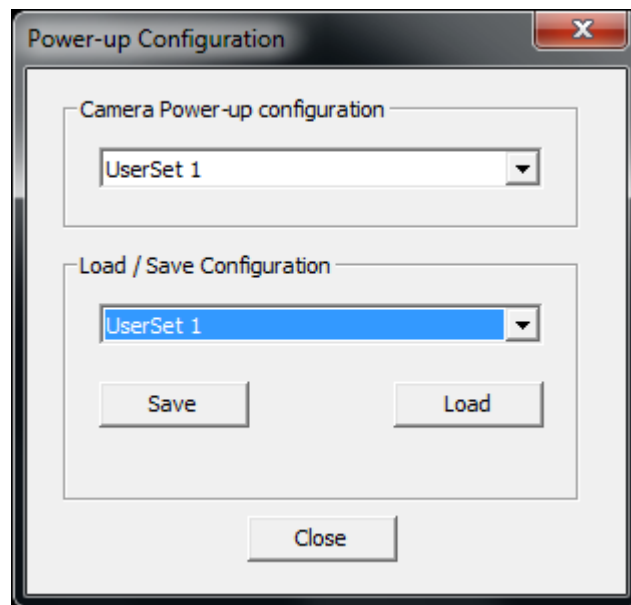

## Image Format Control Category

The Linea GigE Image Format controls, as shown by CamExpert, group parameters used to configure camera pixel format, image cropping, and the binning function. Additionally a feature control to select and output a camera internal test image simplifies qualifying a camera setup without a lens.

Parameters in gray are read only, either always or due to another parameter being disabled. Parameters in black are user set in CamExpert or programmable via an imaging application. Features listed in the description table but tagged as *Invisible* are usually for Teledyne DALSA or third party software usage—not typically needed by end user applications.

Parameters - Visibility: Guru		
Category	Parameter	Value
Camera Information	Pixel Format	BGRa 8-Bit
Sensor Control	Pixel Coding	BGRA Packed
I/O Controls	Pixel Size	8
Counter And Timer Control	Pixel Color Filter	None
Advanced Processing	Horizontal Offset	0
Cycling Preset	Width	4096
	Height	1024
<b>Image Format Controls</b>	Multiple ROI Mode	Off
Acquisition and Transfer Cont...	ROI Count Horizontal	Not Enabled
<input checked="" type="checkbox"/> <b>Device Event Control</b>	ROI Selector	Not Enabled
GigE Vision Transport Layer	ROI Offset X	Not Enabled
File Access Control	ROI Width	Not Enabled
GigE Vision Host Controls	Binning Selector	In Digital Domain
	Binning Averaging	False
	Binning Horizontal	1
	Binning Vertical	1
	Horizontal Flip	False
	Negative Image	False
	End-of-Line Metadata Mode	Off
	End-of-Line Metadata Con...	Exposure Time
	End-of-Line Metadata C...	True
	Reset Metadata FrameCount	Not Enabled
	End-of-Line Metadata Pixe...	0
	Test Image Pattern	Off
	<< Less	

## Image Format Control Feature Description

The following table describes these features along with their view attribute and device version. When a Device Version number is indicated, this represents the camera software functional group,



not a firmware revision number. As Linea GigE capabilities evolve the device version will increase, therefore identifying the supported function package. New features for a major device version release will be indicated by green text for easy identification.

The first column indicates whether a feature applies to monochrome or color camera models via a symbol. No symbol indicates a common feature. Additionally the description column will indicate which feature is a member of the DALSA Features Naming Convention (denoted by DFNC), versus the GenICam Standard Features Naming Convention (SFNC not shown).

Display Name	Feature & Values	Description	Device Version & View
Pixel Format	PixelFormat	Contains all format information as provided by PixelCoding, PixelSize, PixelColorFilter, combined in one single value. Decimation must be Off.	1.00 Beginner
<i>BGRa 8-Bit</i> <i>Green Only 8-bit</i> <i>BiColorRGBG8</i> <i>RGB8</i>	<i>BGRa8</i> <i>G8</i> <i>BiColorRGBG8</i> <i>RGB8</i>	<i>Color Camera: BGRa8</i> <i>Color Camera: Green Only 8-bit</i> <i>Color Camera: RGBG8</i> <i>Color Camera: RGB8</i>	
Pixel Coding	PixelCoding	Output image pixel coding format of the sensor.	1.00 Guru
<i>Mono</i> <i>Raw Bayer</i> <i>BGRA Packed</i>	<i>Mono</i> <i>Raw</i> <i>BGRAPacked</i>	<i>Pixel is monochrome</i> <i>Pixel is raw Bayer</i> <i>Pixel is BGRA 32-bit</i>	
Pixel Size	PixelSize	Total size in bits of an image pixel.	1.00 Guru
<i>8 Bits/Pixel</i>	<i>Bpp8</i>	<i>Bpp8: 8 bits per pixel</i>	
Pixel Color Filter	PixelColorFilter	Indicates the type of color filter applied to the image.	1.00 Guru
<i>None</i>	<i>None</i>	<i>No filter applied on the sensor.</i>	
Horizontal Offset	OffsetX	Horizontal offset from the Sensor Origin to the Area Of Interest (in pixels).	1.00 Beginner
Width	Width	Width of the Image provided by the device (in pixels).	1.00 Beginner
Height	Height	Height of the Image provided by the device (in lines).	1.00 Beginner
multiple ROI Mode	multipleROIMode	Enable the Multiple ROI (Region of Interest) per image feature. The ROI Count is set by the Multiple ROI Count feature.	1.00 Expert DFNC
<i>Off</i> <i>Active</i>	<i>Off</i> <i>Active</i>	<i>Single ROI per image.</i> <i>The ROI per image feature is active.</i>	
ROI Count Horizontal	multipleROICountHorizontal	Specifies the number of ROI (Region of Interest) available for the X axis.	1.00 Expert DFNC
ROI Selector	multipleROISelector	Select an ROI (Region of Interest) when Multiple ROI Mode is enabled. Selector range is from 1 to the Multiple ROI Count value.	1.00 Expert DFNC
<i>ROI (x1, y1)</i> <i>ROI (x2, y1)</i> <i>ROI (x3, y1)</i> <i>ROI (x4, y1)</i>	<i>roi1_1</i> <i>roi2_1</i> <i>roi3_1</i> <i>roi4_1</i>	<i>ROI (x1, y1)</i> <i>ROI (x2, y1)</i> <i>ROI (x3, y1)</i> <i>ROI (x4, y1)</i>	

ROI Offset X	multipleROIOffsetX	Horizontal offset (in pixels) from the origin to the selected ROI (Region of Interest).	1.00 Expert DFNC
ROI Width	multipleROIWidth	Width of the selected ROI (Region of Interest) provided by the device (in pixels). Increment value is device dependent.	1.00 Expert DFNC
Binning Selector	binningSelector	Select how the Horizontal and Vertical Binning is done. The Binning function can occur in the Digital domain of a device or at the actual sensor.  <i>In Sensor</i>  <i>In Digital Domain</i>	1.00 Beginner DFNC
Binning Horizontal	BinningHorizontal	Number of horizontal photo-sensitive cells to combine together. This increases the intensity of the pixels but reduces the horizontal resolution.	1.00 Beginner
Binning Vertical	BinningVertical	Number of vertical photo-sensitive cells to combine together. This increases the intensity of the pixels but reduces the vertical resolution of the image.	1.00 Beginner
Horizontal Flip	ReverseX	Horizontal image flip function.  <i>True</i> <i>False</i>	1.00 Expert
Negative Image	NegativeImage	Invert the pixel brightness to get negative image.  <i>True</i> <i>False</i>	1.00 Expert DFNC
End-of-Line Metadata Mode	endOfLineMetadataMode	Sets the enable state of the End-of-Line Metadata Mode. End-of-Line Metadata allows the inclusion of line statistics such as the average pixel value or peak value with the readout of each line.  <i>Off</i> <i>Active</i>	1.00 Expert DFNC
End-of-Line Metadata Content Selector	endOfLineMetadataContentSelector	Selects the content of the End-of-Line Metadata to control. Each element is part of a QWORD (8 bytes). Enabling a single element in a QWORD will result on sending the complete QWORD on each line.  <i>Exposure Time</i>  <i>Cycling Preset Current Active Set</i>  <i>Flat Field Correction Current Active Set</i>  <i>Digital Gain</i>  <i>Line Status All</i>  <i>Line Counter</i>	1.00 Expert DFNC

Line Trigger Counter	LineTriggerCounter	Control the presence of the line trigger counter in the End-of-Line Metadata. This element is part of QWORD 2.	
Timer1 Active	Timer1Active	Control the presence of the timer1 active in the End-of-Line Metadata. This element is part of QWORD 2.	
Timer2 Active	Timer2Active	Control the presence of the timer2 active in the End-of-Line Metadata. This element is part of QWORD 2.	
Counter1 Active	Counter1Active	Control the presence of the counter1 active in the End-of-Line Metadata. This element is part of QWORD 2.	
Counter2 Active	Counter2Active	Control the presence of the counter2 active in the End-of-Line Metadata. This element is part of QWORD 2.	
Timestamp	Timestamp	Control the presence of the timestamp in the End-of-Line Metadata. This element is part of QWORD 3.	
Timer1 Value	Timer1Value	Control the presence of the timer1 value in the End-of-Line Metadata. This element is part of QWORD 4.	
Timer2 Value	Timer2Value	Control the presence of the timer2 value in the End-of-Line Metadata. This element is part of QWORD 5.	
Counter1 Value	Counter1Value	Control the presence of the Counter1 value in the End-of-Line Metadata. This element is part of QWORD 4.	
Counter2 Value	Counter2Value	Control the presence of the Counter2 value in the End-of-Line Metadata. This element is part of QWORD 5.	
Frame Counter Value	FrameCounter	Control the presence of the frame counter in the end-of-line metadata. This element is QWORD 6.	
Camera ID	CameraID	Control the presence of the camera ID in the end-of-line metadata. This element is QWORD 6.	
End-of-Line Metadata Content Activation Mode	endOfLineMetadataContentActivationMode	Control if the selected element is part of the End-of-Line Metadata.	1.00 Expert DFNC
False	False	The selected element is not part of the End-of-Line Metadata.	
True	True	The selected element is part of the End-of-Line Metadata.	
End-of-Line Metadata Pixel Count	endOfLineMetadataPixelCount	Returns the number of pixel(s) that contains End-of-Line Metadata information.	1.00 Beginner DFNC
Reset Metadata FrameCount	endofLineMetadataResetFrameCount	Reset the frame count in metadata.	1.00 Expert DFNC
Test Image Pattern	TestPattern	Selects the type of test image output by the camera.	1.00 Beginner
Off	Off	Image is from the camera sensor.	
Grey Horizontal Ramp	GreyHorizontalRamp	Image is filled horizontally with an image that goes from the darkest possible value to the brightest.	
Grey Vertical Ramp	GreyVerticalRamp	Image is filled vertically with an image that goes from the darkest possible value to the brightest.	
Dark Gray	DarkGray	2746/1381 pattern.	
Tap Ramp	TapRamp	32/48/64/80 (first 2048 pixels); 96/112/128/144 (second 2048 pixels).	
FlatGray	FlatGray	0x565 test pattern.	
Flat Dark	FlatDark	0x20 test pattern.	

Grey Horizontal Ramp 2	GreyHorizontalRamp2	Image is filled horizontally with an image that goes from the darkest possible value to the brightest. Similar to GreyHorizontalRamp pattern except a small shift in each pixel.	
Width Max	WidthMax	The maximum image width is the dimension calculated after horizontal binning, decimation or any other function changing the horizontal dimension of the image.	1.00 Invisible
Height Max	HeightMax	The maximum image height is the dimension calculated after vertical binning, decimation or any other function changing the vertical dimension of the image.	1.00 Invisible

## Binning

Binning is the process where the charge on two (or more) adjacent pixels is combined. This results in increased light sensitivity since there is twice the sensor area to capture photons. The sensor spatial resolution is reduced but the improved low-light sensitivity plus lower signal-noise ratio may solve a difficult imaging situation. The user can evaluate the results of the binning function (factor of 2x) on the Linea GigE by using CamExpert.

Linea GigE supports horizontal and vertical binning independently. Vertical binning is performed over multiple acquisition lines within the camera. Therefore, the virtual frame buffer height is automatically reduced when binning is enabled. Also note that binning is performed digitally, therefore there is no increase in acquisition line rate. The following graphic illustrates binning.

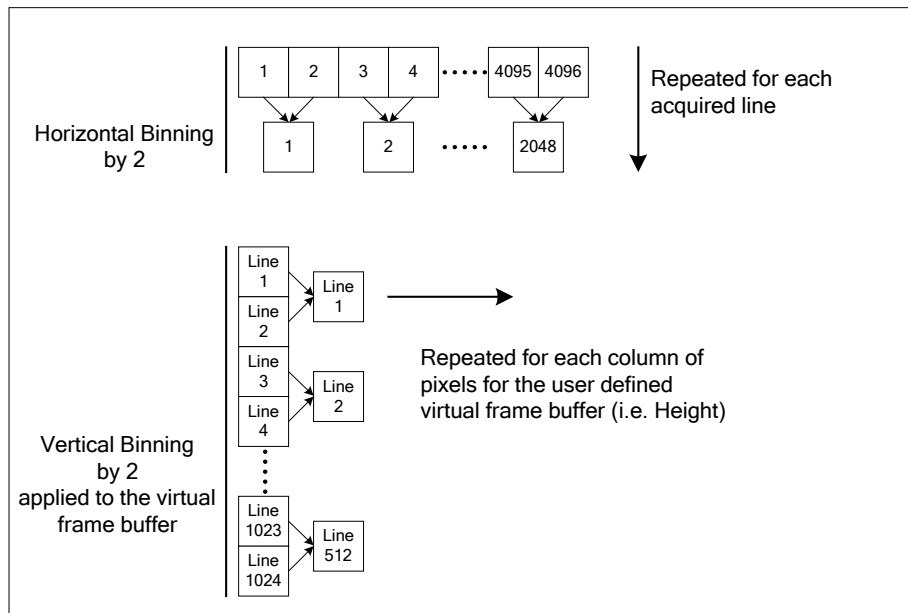

# Metadata Format

The Linea GigE metadata is formatted as follows:

QWORD #	Bits	Feature Name	Description
QWORD 1	63:48	Gain - Digital All	The gain-digital all as an amplification factor applied to the image.
	47:40	Line Status All	The current status of all available line signals in a single bitfield. The order is Line1, Line2, Line3, ...
	39:36	Flat Field Correction Current Active Set	The index of the current set of Flat Field coefficients being used.
	35:32	Cycling Preset Current Active Set	The index of the currently active cycling preset.
	31:0	Exposure Time	The exposure time, where 1 DN = 10 ns.
QWORD 2	63:56	<i>Unused</i>	
	55:32	Line Trigger Counter	Counts the total # of line triggers received during the current frame
	31:28	<i>Unused</i>	
	27:25	Counter2 Active	The status of counter # where: 0=Idle 1=Trigger Wait 2=Active 3=Completed 4=Overflow 5=Wait
	24:22	Counter1 Active	
	21:19	Timer2 Active	The status of timer # where: 0=Idle 1=Trigger Wait 2=Active 3=Completed 5=Delaying
	18:16	Timer1 Active	
	15:0	Line Counter	Specifies the position of a line within the current frame.
QWORD 3	63:0	Timestamp	The value of the timestamp counter.
QWORD 4	63:32	Timer1 Value	The value of timer 1.
	31:0	Counter1 Value	The value of counter 1.
QWORD 5	63:32	Timer2 Value	The value of timer 2.
	31:0	Counter2 Value	The value of counter 2.
QWORD 6	63:32	Camera ID	The identifier of the device. This may be user-defined, but defaults to the serial number.
	31:0	FrameCounter Value	Increments at the start of each frame.

## Internal Test Image Generator

The Linea GigE camera includes a number of internal test patterns which easily confirm camera Ethernet connections or driver installations, without the need for a camera lens or proper lighting. The patterns are subject to Linea GigE processing such as Binning functions.

Use CamExpert to easily enable and select any test pattern from the drop menu while the camera is not in acquisition mode. Select live grab to see the pattern output.

---

## Acquisition and Transfer Control Category

The Linea GigE Acquisition and Transfer controls, as shown by CamExpert, groups parameters used to configure the optional acquisition modes of the device. These features provide the mechanism to either have acquisitions coupled to transfers (basic mode) or to decouple acquisitions from both the camera transfer module and the host transfer module.

Parameters in gray are read only, either always or due to another parameter being disabled. Parameters in black are user set in CamExpert or programmable via an imaging application.

Features listed in the description table but tagged as *Invisible* are usually for Teledyne DALSA or third party software usage—not typically needed by end user applications.

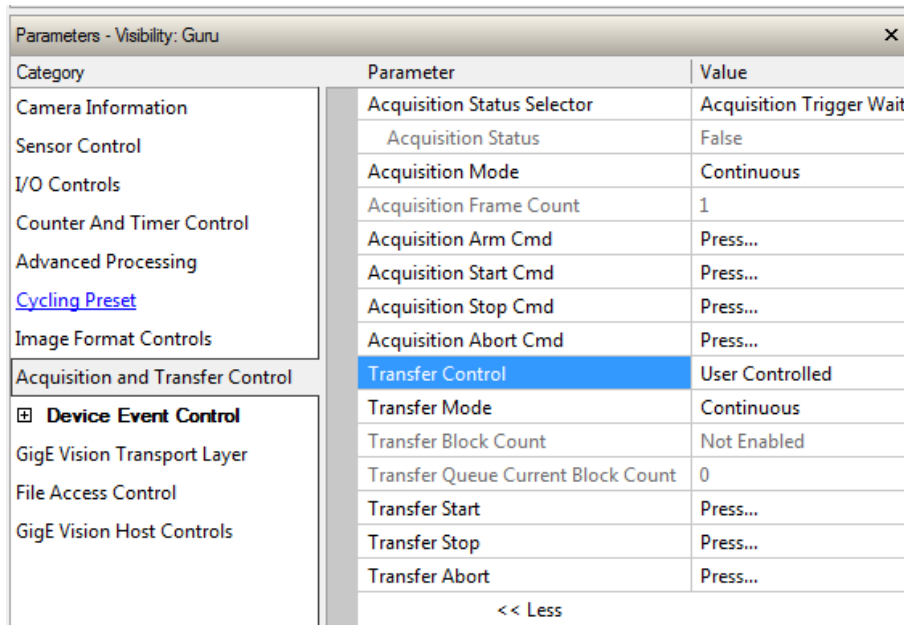

Category	Parameter	Value
Acquisition and Transfer Control	Acquisition Status Selector	Acquisition Trigger Wait
	Acquisition Status	False
	Acquisition Mode	Continuous
	Acquisition Frame Count	1
	Acquisition Arm Cmd	Press...
	Acquisition Start Cmd	Press...
	Acquisition Stop Cmd	Press...
	Acquisition Abort Cmd	Press...
	Transfer Control	User Controlled
	Transfer Mode	Continuous
	Transfer Block Count	Not Enabled
	Transfer Queue Current Block Count	0
	Transfer Start	Press...
Transfer Stop	Press...	
Transfer Abort	Press...	

## Acquisition and Transfer Control Feature Descriptions

The following table describes these parameters along with their view attribute and minimum camera firmware version required. Additionally the Device Version column will indicate which parameter is a member of the DALSA Features Naming Convention (denoted by DFNC), versus the GenICam Standard Features Naming Convention (SFNC not shown).

The Device Version number represents the camera software functional group, not a firmware revision number. As Linea GigE capabilities evolve the device version tag will increase, therefore

identifying the supported function package. New features for a major device version release will be indicated by green text for easy identification.

Display Name	Feature & Values	Description	Device Version & View
Acquisition Status Selector	AcquisitionStatusSelector	Selects the internal acquisition signal to read using <i>AcquisitionStatus</i> .	1.00 Expert
<i>Acquisition Trigger Wait</i>	<i>AcquisitionTriggerWait</i>	<i>Device is currently waiting for a trigger to capture one or more frames.</i>	
<i>Acquisition Active</i>	<i>AcquisitionActive</i>	<i>Device is currently doing an acquisition of one or more frames.</i>	
<i>Acquisition Transfer</i>	<i>AcquisitionTransfer</i>	<i>Device is currently transferring an acquisition of one or more frames.</i>	
<i>Frame Trigger Wait</i>	<i>FrameTriggerWait</i>	<i>Device is currently waiting for a frame trigger.</i>	
<i>Frame Active</i>	<i>FrameActive</i>	<i>Device is currently capturing a frame.</i>	
<i>Frame Transfer</i>	<i>FrameTransfer</i>	<i>Device is currently transferring a frame.</i>	
<i>Exposure Active</i>	<i>ExposureActive</i>	<i>Device is exposing a frame.</i>	
Acquisition Status	AcquisitionStatus	Reads the state of the internal acquisition signal selected using the <i>AcquisitionStatusSelector</i> feature.	1.00 Expert
Acquisition Mode	AcquisitionMode	Set the acquisition mode of the device. It defines the number of frames to capture during an acquisition and the way the acquisition stops.	1.00 Beginner
<i>Single Frame</i>	<i>SingleFrame</i>	<i>One frame is captured for each AcquisitionStart Command. An AcquisitionStop occurs at the end of the Active Frame.</i>	
<i>Multi-Frame</i>	<i>MultiFrame</i>	<i>A sequence of frames is captured for each AcquisitionStart Command. The number of frames is specified by AcquisitionFrameCount feature. An AcquisitionStop occurs at the end of the Active Frame(s)</i>	
<i>Continuous</i>	<i>Continuous</i>	<i>Frames are captured continuously with AcquisitionStart until stopped with the AcquisitionStop command.</i>	
Acquisition Frame Count	AcquisitionFrameCount	Number of frames to be acquired in MultiFrame acquisition mode.	1.00 Beginner
Acquisition Arm Cmd	AcquisitionArm	Arms the device before an AcquisitionStart command. This optional command validates all the current features for consistency and prepares the device for a fast start of the acquisition. If not used explicitly, this command is automatically executed at the first AcquisitionStart but will not be repeated for subsequent ones unless a data transfer related feature is changed in the device. (WO)	1.00 Guru
Acquisition Start Cmd	AcquisitionStart	Start image capture using the currently selected acquisition mode. The number of frames captured is specified by AcquisitionMode feature. (WO)	1.00 Beginner
Acquisition Stop Cmd	AcquisitionStop	Stops the Acquisition of the device at the end of the current frame unless the triggerFrameCount feature is greater than 1. (WO)	1.00 Beginner
Acquisition Abort Cmd	AcquisitionAbort	Aborts the acquisition immediately. This will end the capture without completing the current Frame or aborts waiting on a trigger. If no acquisition is in progress, the command is ignored. (WO)	1.00 Beginner
<u>Transfer Control</u>	TransferControlMode	Sets the method used to control the transfer.	1.00 Expert
<i>Basic</i>	<i>Basic</i>	<i>Basic mode ensures maximum compatibility but does not allow for control of the transfer flow.</i>	
<i>User Controlled</i>	<i>UserControlled</i>	<i>Manual mode allows maximum control of the transfer flow.</i>	
Transfer Mode	TransferOperationMode	Sets the operation mode of the transfer.	1.00 Expert
<i>Continuous</i>	<i>Continuous</i>	<i>Blocks are transferred continuously until stopped with the TransferStop command.</i>	



<i>Multi Block</i>	<i>MultiBlock</i>	<i>The transfer terminates after the transition on TransferBlockCount or before on a user request.</i>	
Transfer Block Count	TransferBlockCount	Specifies the number of Data Blocks the device must stream during the next transfer.	1.00 Expert
Transfer Queue Current Block Count	transferQueueCurrentBlockCount	Returns the current number of blocks in the transfer queue.	1.00 Expert
Transfer Start	TransferStart	Starts the streaming of data Block(s) to another device.	1.00 Expert
Transfer Stop	TransferStop	Stops the streaming of data Block(s) to another device.	1.00 Expert
Transfer Abort	TransferAbort	Aborts the streaming of data Block(s) to another device.	1.00 Expert

## ***Acquisition Buffering***

All acquisitions are internally buffered and transferred as fast as possible to the host system. This internal buffer allows uninterrupted acquisitions no matter of any transfer delays that might occur (such as acquisition rates faster than the Gigabit Ethernet link or the IEEE Pause frame). Only when the internal buffer is consumed would an Image Lost Event be generated.

The camera has 1 block of 256MB. A portion of the memory could be reserved for packet resends but at the loss of accumulating frames.

## ***Using Transfer Queue Current Block Count with CamExpert***

This feature returns the number of frames buffered within the Linea GigE pending transfer to the host system. Image lines/frames are buffered in cases where the host system is temporarily busy or cases of high network traffic with other devices through the same Ethernet switch. By buffering image frames, the Linea GigE will not need to drop data when there are temporary delays to the transfer.

When using CamExpert, right click on this field and then click on Refresh from the pop-up menu. The current frame count in the transfer buffer is displayed in the *Value* field. During live grab, if the number of frames in the transfer buffer is increasing, then there is a problem with the network or host bandwidth being exceeded. The ImageLost event occurs when all buffer space is consumed.

## ***Overview of Transfer Control (TransferControlMode)***

Linea GigE acquisition transfers operate either in the basic coupled mode or in an independent decoupled user controlled mode, as described below.

### ***TransferControlMode = Basic***

The Basic Transfer Mode provides maximum compatibility with any control application running on the host computer. In this mode, the host based acquisition program commands the camera to do a frame grab, send it through the camera's frame buffer to the camera's transfer module, where it is then received by the host. The acquisition rate is limited by the transfer rate to host.

### ***TransferControlMode = UserControlled***

The User Controlled Transfer Mode decouples the camera acquisition module from the camera transfer module and also from the host computer transfer module. The user has total control of each of the three control modules. Some important points are:

- The acquisition module writes frames into the camera's circular frame buffer memory. Only when all buffers are written will the next acquisition overwrite a previously stored image (this also generates the ImageLost event).

- The camera transfer module is independent of the acquisition. This allows the acquisition to not be interrupted by any network delays or traffic on the connection with the controlling host computer.
- The host computer also has independent control of the host transfer module which allows the host application to optimize receiving image packets along with other tasks running on the host.
- Important: Under user controlled transfers, the feature *TransferOperationMode* sets the transfer as either Continuous or a specific image frame count (MultiBlock). The transfer frame count is set by the feature *TransferBlockCount*, which must be equal or less than the number of image frames available in the camera's circular frame buffer (else the command is rejected). The feature *transferQueueCurrentBlockCount* is used to read the available buffer count before starting a block count transfer.

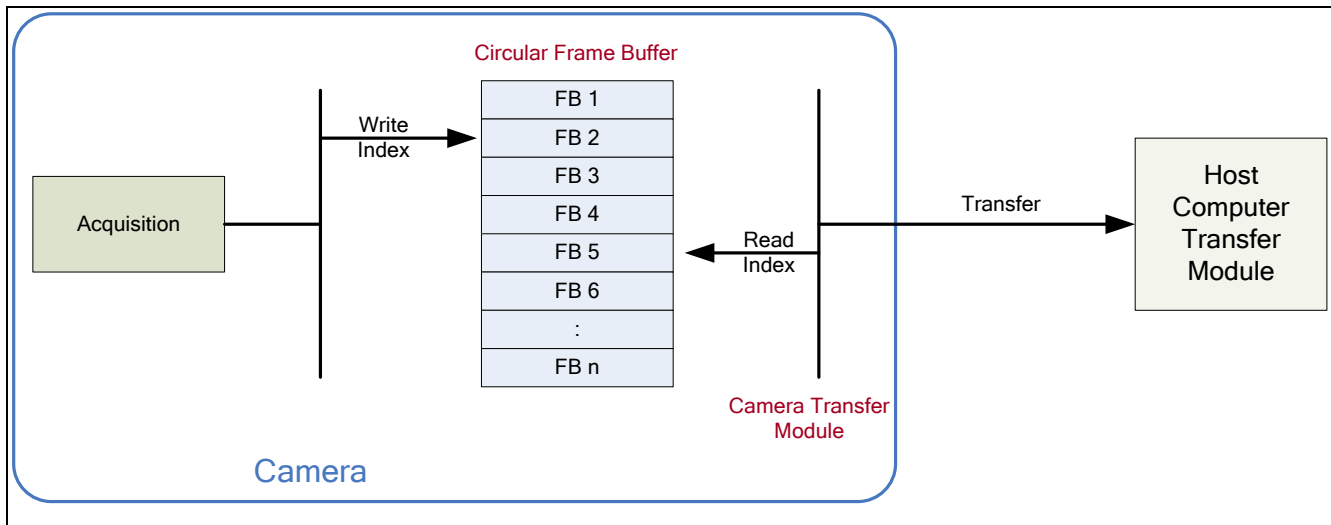

## Features that cannot be changed during a Sopera transfer

The following features cannot be changed during an acquisition or when a Sopera transfer is connected.

Feature Group	Features Locked During a Sopera Transfer
<u>CAMERA INFORMATION</u>	UserSetLoad
<u>SENSOR CONTROL</u>	NA
<u>I/O CONTROL</u>	NA
<u>COUNTER AND TIMER CONTROL</u>	NA
<u>ADVANCED PROCESSING CONTROL</u>	flatfieldCorrectionMode
<u>CYCLING PRESET MODE CONTROL</u>	cyclingPresetMode cP_FeaturesActivationMode cP_FlatfieldCorrectionMode
<u>IMAGE FORMAT CONTROL</u>	PixelFormat OffsetX OffsetY Width Height BinningHorizontal BinningVertical
<u>ACQUISITION AND TRANSFER CONTROL</u>	DeviceRegistersStreamingStart DeviceRegistersStreamingEnd
<u>EVENT CONTROL</u>	NA
<u>GIGE VISION TRANSPORT LAYER CONTROL</u>	GevSCPSPacketSize
<u>GIGE VISION HOST CONTROL</u>	InterPacketTimeout InterPacketTimeoutRaw ImageTimeout
<u>FILE ACCESS CONTROL</u>	NA

# Event Control Category

The Linea GigE Event control, as shown by CamExpert, group parameters used to configure Camera Event related features. Parameters in gray are read only, either always or due to another parameter being disabled. Parameters in black are user set in CamExpert or programmable via an imaging application.

Features listed in the description table but tagged as *Invisible* are usually for Teledyne DALSA or third party software usage—not typically needed by end user applications.

Category	Parameter	Value
Acquisition and Transfer Control	Timestamp Latch Cmd	Press...
Device Event Control	Timestamp Value	0
Event Info	TimeStamp Source	Internal Clock
Acquisition Start Data	Timestamp Tick Frequency (in Hz)	1000000
Acquisition End Data	Timestamp Reset Cmd	Press...
Frame Start Data	Event Selector	Start of Acquisition
Valid Frame Trigger Data	Event Notification	Off
Invalid Frame Trigger Data	Event Line Activation	Not Enabled
Image lost Data	Event Statistic Selector	Image Lost
Line Trigger Overflow Data	Event Statistic Count	0
Invalid Line Trigger Data	Event Statistic Count Reset	Press...
Line 1 Data	<< Less	
Line2 Data		
Line3 Data		
Line4 Data		
Line3Pulse Data		
Line4Pulse Data		
Line5Pulse Data		
Event Overflow Data		

## Event Control Feature Descriptions

The following table describes these parameters along with their view attribute and minimum camera firmware version required. Additionally the Device Version column will indicate which parameter is a member of the DALSA Features Naming Convention (denoted by DFNC), versus the GenICam Standard Features Naming Convention (SFNC not shown).

The Device Version number represents the camera software functional group, not a firmware revision number. As Linea GigE capabilities evolve the device version tag will increase, therefore identifying the supported function package. New features for a major device version release will be indicated by green text for easy identification.

Display Name	Feature & Values	Description	Device Version & View
Timestamp Latch Cmd	timestampControlLatch	Latch the current timestamp internal counter value in the timestampValue feature.	1.00 Expert DFNC
Timestamp Value	timestampValue	Returns the 64-bit value of the timestamp counter. (RO)	1.00 Expert DFNC
TimeStamp Source  <i>Internal Clock</i>	timestampSource  <i>InternalClock</i>	Specifies the source used as the incrementing signal for the Timestamp register.  <i>The timestamp source is generated by the camera internal clock. Refer to the timestampTickFrequency feature for the time base.</i>	1.00 Expert DFNC
Timestamp Tick Frequency(in Hz)	timestampTickFrequency	Indicates the number of timestamp ticks (or increments) during 1 second (frequency in Hz). (RO)	1.00 Expert DFNC
Timestamp Reset Cmd	timestampControlReset	Resets the timestamp counter to 0. (WO)	1.00 Expert DFNC
Event Selector	EventSelector	Select the Event to enable/disable with the EventNotification feature.	1.00 Expert
<i>Start of Acquisition</i>	<i>AcquisitionStart</i>	<i>Event sent on control channel on acquisition start.</i>	
<i>End of Acquisition</i>	<i>AcquisitionEnd</i>	<i>Event sent on control channel on acquisition end.</i>	
<i>Start of Frame</i>	<i>FrameStart</i>	<i>Event sent on control channel on an Active Frame. This occurs with the start of the exposure delay of the first line of the frame.</i>	
<i>End of Frame</i>	<i>FrameEnd</i>	<i>Event sent on control channel on an Active Frame end.</i>	
<i>Valid Frame Trigger</i>	<i>ValidFrameTrigger</i>	<i>Event sent on control channel when a valid frame trigger is generated.</i>	
<i>Invalid Frame Trigger</i>	<i>InvalidFrameTrigger</i>	<i>Event sent on control channel when a frame trigger occurs in an invalid Trigger region. Therefore the trigger is rejected and no frame acquisition occurs.</i>	
<i>Image Lost</i>	<i>ImageLost</i>	<i>Event sent on control channel when an image is lost due to insufficient memory.</i>	
<i>Invalid Line Trigger</i>	<i>InvalidLineTrigger</i>	<i>Event sent on control channel when a line trigger occurs in an invalid Trigger region. Therefore the trigger is rejected and no frame acquisition occurs.</i>	
<i>Line Trigger Overlap</i>	<i>LineTriggerOverlap</i>	<i>Event sent on control channel when a line trigger occurs in an invalid trigger region and was delayed by the camera into a valid region.</i>	
<i>Line 1</i>	<i>Line1</i>	<i>Event sent on control channel when a state change occurs on line 1.</i>	

<i>Line 2</i>	<i>Line2</i>	Event sent on control channel when a state change occurs on line 2.	
<i>Line 3</i>	<i>Line3</i>	Event sent on control channel when a state change occurs on line 3.	
<i>Line 4</i>	<i>Line4</i>	Event sent on control channel when a state change occurs on line 4.	
<i>Line 3 Pulse Start</i>	<i>Line3PulseStart</i>	Event sent on control channel when a pulse is generated on line 3.	
<i>Line 4 Pulse Start</i>	<i>Line4PulseStart</i>	Event sent on control channel when a pulse is generated on line 4.	
<i>Line 5 Pulse Start</i>	<i>Line5PulseStart</i>	Event sent on control channel when a pulse is generated on line 5.	
<i>Line 6 Pulse Start</i>	<i>Line6PulseStart</i>	Event sent on control channel when a pulse is generated on line 6.	
<i>Events Overflow</i>	<i>eventsOverflow</i>	Event sent on control channel when all previous active events have been disabled because the camera cannot send them fast enough, generating an internal message overflow. All required events must be re-enabled manually.	
Event Notification	EventNotification	Enable Events for the event type selected by the EventSelector feature.	1.00 Expert
<i>Off</i>	<i>Off</i>	The selected event is disabled.	
<i>On</i>	<i>On</i>	The selected event will generate a software event.	
<i>GigEVisionEvent</i>	<i>GigEVisionEvent</i>	The selected event will generate a software event for SFNC 1.x compatibility.	
Event Line Activation	eventLineActivation	Controls the activation of the line event. This is only used for input line configurations. Output lines only generate events on pulses start.	1.00 Expert
<i>Rising Edge</i>	<i>RisingEdge</i>	The event is generated on the line rising edge.	
<i>Falling Edge</i>	<i>FallingEdge</i>	The event is generated on the line falling edge.	
<i>Any Edge</i>	<i>AnyEdge</i>	The event is generated on any line edge.	
Event Statistic Selector	eventStatisticSelector	Selects which Event statistic to display.	1.00 Expert DFNC
<i>Start of Acquisition</i>	<i>AcquisitionStart</i>	Event sent on control channel on acquisition start.	
<i>End of Acquisition</i>	<i>AcquisitionEnd</i>	Event sent on control channel on acquisition end.	
<i>Start of Frame</i>	<i>FrameStart</i>	Event sent on control channel on an Active Frame. This occurs with the start of the exposure delay.	
<i>End of Frame</i>	<i>FrameEnd</i>	Event sent on control channel on an Active Frame end.	
<i>Valid Frame Trigger</i>	<i>ValidFrameTrigger</i>	Event sent on control channel when a valid frame trigger is generated.	
<i>Invalid Frame Trigger</i>	<i>InvalidFrameTrigger</i>	Event sent on control channel when a frame trigger occurs in an invalid Trigger region. Therefore the trigger is rejected and no frame acquisition occurs.	
<i>Image Lost</i>	<i>ImageLost</i>	Event sent on control channel when an image is lost due to insufficient memory.	
<i>Invalid Line Trigger</i>	<i>InvalidLineTrigger</i>	Event sent on control channel when a line trigger occurs in an invalid Trigger region. Therefore the trigger is rejected and no frame acquisition occurs.	
<i>Line Trigger Overlap</i>	<i>LineTriggerOverlap</i>	Event sent on control channel when a line trigger occurs in an invalid trigger region and was delayed by the camera into a valid region.	
<i>Line 1</i>	<i>Line1</i>	Event sent on control channel when a state change occurs on line 1.	
<i>Line 2</i>	<i>Line2</i>	Event sent on control channel when a state change occurs on line 2.	
<i>Line 3</i>	<i>Line3</i>	Event sent on control channel when a state change occurs on line 3.	

<i>Line 4</i>	<i>Line4</i>	<i>Event sent on control channel when a state change occurs on line 4.</i>	
<i>Line 3 Pulse Start</i>	<i>Line3PulseStart</i>	<i>Event sent on control channel when a pulse is generated on line 3.</i>	
<i>Line 4 Pulse Start</i>	<i>Line4PulseStart</i>	<i>Event sent on control channel when a pulse is generated on line 4.</i>	
<i>Line 5 Pulse Start</i>	<i>Line5PulseStart</i>	<i>Event sent on control channel when a pulse is generated on line 5.</i>	
<i>Line 6 Pulse Start</i>	<i>Line6PulseStart</i>	<i>Event sent on control channel when a pulse is generated on line 6.</i>	
Event Statistic Count	eventStatisticCount	Display the count of the selected Event.	1.00 Expert DFNC
Event Statistic Count Reset	eventStatisticCountReset	Reset the count of the selected Event.	1.00 Expert DFNC
Acquisition Start Data	EventAcquisitionStartData	Data of the acquisition start event.	1.00 Guru
Acquisition End Data	EventAcquisitionEndData	Data of the acquisition end event.	1.00 Guru
Acquisition Start Event ID	EventAcquisitionStart	Represents the event ID to identify the EventAcquisitionStart software event.	1.00 Guru
Acquisition Start Event Timestamp	EventAcquisitionStartTimestamp	Timestamp of the EventAcquisitionStart event. (RO)	1.00 Guru
Acquisition End Event ID	EventAcquisitionEnd	Represents the event ID to identify the EventAcquisitionEnd software Event. (RO)	1.00 Guru
Acquisition End Event Timestamp	EventAcquisitionEndTimestamp	Timestamp of the EventAcquisitionEnd event. (RO)	1.00 Guru
Frame Start Data	EventFrameStartData	Data of the frame start event.	1.00 Guru
Frame Start Event ID	EventFrameStart	Represents the event ID to identify the EventFrameStart software Event. (RO)	1.00 Guru
Frame Start Event Timestamp	EventFrameStartTimestamp	Timestamp of the EventFrameStart event. (RO)	1.00 Guru
Frame End Data	EventFrameEndData	Data of the frame end event.	1.00 Guru
Frame End Event ID	EventFrameEnd	Represents the event ID to identify the EventFrameEnd software Event.	1.00 Guru
Frame End Event Timestamp	EventFrameEndTimestamp	Timestamp of the EventFrameEnd event.	1.00 Guru
Valid Frame Trigger Data	EventValidFrameTriggerData	Data of the valid frame trigger event.	1.00 Guru
Valid Frame Trigger Event ID	EventValidFrameTrigger	Generate an event on valid frame trigger.	1.00 Guru
Valid Frame Trigger Event Timestamp	EventValidFrameTriggerTimestamp	Timestamp of the valid frame trigger event.	1.00 Guru
Invalid Frame Trigger Data	EventInvalidFrameTriggerData	Data of the invalid frame trigger event.	1.00 Guru
Invalid Frame Trigger Event ID	EventInvalidFrameTrigger	Generate an event on an invalid frame trigger.	1.00 Guru
Invalid Frame Trigger Event Timestamp	EventInvalidFrameTriggerTimestamp	Timestamp of the invalid frame trigger event.	1.00 Guru
Image lost Data	EventImageLostData	Data of the image lost event.	1.00 Guru
Image Lost Event ID	EventImageLost	Generate an event on image lost.	1.00 Guru
Image Lost Event Timestamp	EventImageLostTimestamp	Timestamp of the image lost event.	1.00 Guru
Line Trigger Overflow Data	EventLineTriggerOverlapData	Data of the line trigger overflow event.	1.00 Guru

Line Trigger Overlap ID	EventLineTriggerOverlap	Represents the event ID to identify the LineTriggerOverlap Event.	1.00 Guru
Line Trigger Overlap event Timestamp	EventLineTriggerOverlapTimestamp	Timestamp of the LineTriggerOverlap event.	1.00 Guru
Invalid Line Trigger Data	EventInvalidLineTriggerData	Data of the invalid line trigger event.	1.00 Guru
Invalid Line Trigger ID	EventInvalidLineTrigger	Represents the event ID to identify the InvalidLineTrigger Event.	1.00 Guru
Invalid Line Trigger event Timestamp	EventInvalidLineTriggerTimestamp	Timestamp of the InvalidLineTrigger event.	1.00 Guru
Line 1 Data	EventLine1Data	Data of the line 1 event.	1.00 Guru
Line 1 Event ID	EventLine1	Represents the event ID to identify the Line1 Event.	1.00 Guru
Line1 Event Timestamp	EventLine1Timestamp	Timestamp of the Line1 event.	1.00 Guru
Line 2 Data	EventLine2Data	Data of the line 2 event.	1.00 Guru
Line 2 Event ID	EventLine2	Represents the event ID to identify the Line2 Event.	1.00 Guru
Line2 Event Timestamp	EventLine2Timestamp	Timestamp of the Line2 event.	1.00 Guru
Line 3 Data	EventLine3Data	Data of the line 3 event.	1.00 Guru
Line 3 Event ID	EventLine3	Represents the event ID to identify the Line3 Event.	1.00 Guru
Line3 Event Timestamp	EventLine3Timestamp	Timestamp of the Line3 event.	1.00 Guru
Line 4 Data	EventLine4Data	Data of the line 4 event.	1.00 Guru
Line 4 Event ID	EventLine4	Represents the event ID to identify the Line4 Event.	1.00 Guru
Line4 Event Timestamp	EventLine4Timestamp	Timestamp of the Line4 event.	1.00 Guru
Line3Pulse Data	EventLine3PulseStartData	Data of the line 3 pulse event.	1.00 Guru
Line3Pulse Event ID	EventLine3PulseStart	Represents the event ID to identify the Line 3 pulse generator Event.	1.00 Guru
Line3Pulse Event Timestamp	EventLine3PulseStartTimestamp	Timestamp of the Line3 Pulse event.	1.00 Guru
Line4Pulse Data	EventLine4PulseStartData	Data of the line 4 pulse event.	1.00 Guru
Line4Pulse Event ID	EventLine4PulseStart	Represents the event ID to identify the Line 4 pulse generator Event.	1.00 Guru
Line4Pulse Event Timestamp	EventLine4PulseStartTimestamp	Timestamp of the Line4 Pulse event.	1.00 Guru
Line5Pulse Data	EventLine5PulseStartData	Data of the line 5 pulse event.	1.00 Guru
Line5Pulse Event ID	EventLine5PulseStart	Represents the event ID to identify the Line 5 pulse generator Event.	1.00 Guru
Line5Pulse Event Timestamp	EventLine5PulseStartTimestamp	Timestamp of the Line5 Pulse event.	1.00 Guru
Line6Pulse Data	EventLine6PulseStartData	Data of the line 6 pulse event.	1.00 Guru
Line6Pulse Event ID	EventLine6PulseStart	Represents the event ID to identify the Line 6 pulse generator Event.	1.00 Guru
Line6Pulse Event Timestamp	EventLine6PulseStartTimestamp	Timestamp of the Line6 Pulse event.	1.00 Guru
Event Overflow Data	EventeventsOverflowData	Data of the event overflow event.	1.00 Guru
Events Overflow Event ID	EventeventsOverflow	Represents the event ID to identify the EventeventsOverflow software Event. (RO)	1.00 Guru
Events Overflow Event Timestamp	EventeventsOverflowTimestamp	Timestamp of the EventeventsOverflow event. (RO)	1.00 Guru



Gev Timestamp Latch	GevtimestampControlLatch	Latch the current timestamp internal counter value in the timestampValue feature. (WO)	1.00 Invisible
Gev Timestamp Value	GevtimestampValue	Returns the 64-bit value of the timestamp counter. (RO)	1.00 Invisible
Gev Timestamp Tick Frequency	GevtimestampTickFrequency	Indicates the number of timestamp ticks (or increments) during 1 second (frequency in Hz). (RO)	1.00 Invisible
Gev Timestamp Reset	GevtimestampControlReset	Resets the timestamp counter to 0. (WO)	1.00 Invisible

# GigE Vision Transport Layer Control Category

The Linea GigE GigE Vision Transport Layer control, as shown by CamExpert, groups parameters used to configure features related to GigE Vision specification and the Ethernet Connection. Parameters in gray are read only, either always or due to another parameter being disabled. Parameters in black are user set in CamExpert or programmable via an imaging application.

Features listed in the description table but tagged as *Invisible* are usually for Teledyne DALSA or third party software usage—not typically needed by end user applications.

Category	Parameter	Value
Camera Information	Device UPnP Auto-Discovery Mode	Active
Sensor Control	Stream Channel Selector	0
I/O Controls	Device Link Speed (in Mbps)	1000
Counter And Timer Control	PacketSize	9000
Advanced Processing	Interpacket Delay	0
Cycling Preset	Packet Resend Buffer Size	25.0
Image Format Controls	Payload Size	4194304
Acquisition and Transfer Control	IP Configuration Status	ForceIP
<b>Device Event Control</b>	Current IP Address	169.254.169.169
<b>GigE Vision Transport Layer</b>	Current Subnet Mask	255.255.0.0
File Access Control	Current Default Gateway	0.0.0.0
GigE Vision Host Controls	Current IP set in LLA	True
	Current IP set in DHCP	True
	Current IP set in PersistentIP	False
	Primary Application IP Address	169.254.104.101
	Device Access Privilege Control	Exclusive Access
	Discovery Acknowledge Delay	Not Enabled
	Current Heartbeat Timeout	3000
	GVCP Heartbeat Disable	Not Enabled
	Communication Timeout (in msec)	0
	Communication Retransmissions C...	0

## GigE Vision Transport Layer Feature Descriptions

The following table describes these parameters along with their view attribute and minimum camera firmware version required. Additionally the Device Version column will indicate which parameter is a member of the DALSA Features Naming Convention (denoted by DFNC), versus the GenICam Standard Features Naming Convention (SFNC not shown).

The Device Version number represents the camera software functional group, not a firmware revision number. As Linea GigE capabilities evolve the device version tag will increase, therefore identifying the supported function package. New features for a major device version release will be indicated by green text for easy identification.

Display Name	Feature & Values	Description	Device Version & View
<u>Device UPnP Auto-Discovery Mode</u>  <i>Off</i>  <i>Active</i>	deviceUPnPDiscoveryMode  <i>Off</i>  <i>Active</i>	Controls the operation mode for the UPnP Discovery function.  <i>UPNP Device will not broadcast its existence on the network and is not visible in the Windows network neighborhood.</i>  <i>UPNP Device will broadcast its existence on the network and is visible in the Windows network neighborhood.</i>	1.00 Beginner
Payload Size	PayloadSize	Provides the number of bytes transferred for each image or chunk on the stream channel. (RO)	1.00 Beginner
Stream Channel Selector	GevStreamChannelSelector	Selects the stream channel to control.	1.00 Expert
Device Link Speed	GevLinkSpeed	Indicates the transmission speed negotiated by the given network interface. (in Mbps) (RO)	1.00 Expert
PacketSize	GevSCPSPacketSize	Specifies the stream packet size in bytes to send on this channel.	1.00 Expert
Interpacket Delay	GevSCPD	Indicates the delay (in $\mu$ s) to insert between each packet for this stream channel.	1.00 Expert
<u>Packet Resend Buffer Size</u>	devicePacketResendBufferSize	Indicates the amount of memory to reserve in MBytes for the packet resend buffer	1.00 DFNC Guru
IP Configuration Status  <i>None</i> <i>PersistentIP</i>  <i>DHCP</i>  <i>LLA</i>  <i>ForceIP</i>	GevIPConfigurationStatus  <i>None</i> <i>PersistentIP</i>  <i>DHCP</i>  <i>LLA</i>  <i>ForceIP</i>	Reports the current IP configuration status. (RO)  <i>Device IP Configuration is not defined.</i>  <i>Device IP Address Configuration is set to Persistent IP (static).</i>  <i>Device IP Address Configuration is set to DHCP (Dynamic Host Configuration Protocol). Network requires a DHCP server.</i>  <i>Device IP Address Configuration is set to LLA (Link-Local Address). Also known as Auto-IP. Used for unmanaged networks including direct connections from a device to a dedicated NIC.</i>  <i>Device IP Address Configuration is set to ForceIP. Used to force an IP address change.</i>	1.00 Guru
Current IP Address	GevCurrentIPAddress	Reports the IP address for the given network interface. (RO)	1.00 Beginner
Current Subnet Mask	GevCurrentSubnetMask	Reports the subnet mask of the given interface. (RO)	1.00 Beginner
Current Default Gateway	GevCurrentDefaultGateway	Reports the default gateway IP address to be used on the given network interface. (RO)	1.00 Beginner
Current IP set in LLA	GevCurrentIPConfigurationLLA	Controls whether the LLA (Link Local Address) IP configuration scheme is activated on the given network interface. (RO)	1.00 Guru
Current IP set in DHCP	GevCurrentIPConfigurationDHCP	Controls whether the DHCP IP configuration scheme (Dynamic Host Configuration Protocol) is activated on the given network interface.	1.00 Guru
Current IP set in Persistent IP	GevCurrentIPConfigurationPersistentIP	Controls whether the PersistentIP configuration scheme is activated on the given network interface.	1.00 Guru

Primary Application IP Address	GevPrimaryApplicationIPAddress	Returns the IP address of the device hosting the primary application. (RO)	1.00 Guru
Device Access Privilege Control  <i>Exclusive Access</i>  <i>Control Access</i>	  <i>ExclusiveAccess</i>  <i>ControlAccess</i>	Controls the device access privilege of an application.  <i>Grants exclusive access to the device to an application. No other application can control or monitor the device.</i>  <i>Grants control access to the device to an application. No other application can control the device.</i>	1.00 Guru DFNC
Discovery Acknowledge Delay	GevDiscoveryAckDelay	Indicates the maximum randomized delay the device will wait to acknowledge a discovery command. (RO)	1.00 Guru
Current Heartbeat Timeout	GevHeartbeatTimeout	Indicates the current heartbeat timeout in milliseconds.	1.00 Guru
GVCP Heartbeat Disable	GevGVCPHeartbeatDisable	Disables the GVCP (GigE Vision Control Protocol) heartbeat monitor. This allows control switchover to an application on another device.	1.00 Expert
Communication Timeout	GevMCTT	Provides the transmission timeout value in milliseconds.	1.00 Guru
Communication Retransmissions Count	GevMCRC	Indicates the number of retransmissions allowed when a message channel message times out.	1.00 Guru
Gev GVSP Extended ID Mode	GevGVSPExtendedIDMode	Enables the extended IDs mode.	1.00 Expert
Stream Channel Selector	GevStreamChannelSelector	Selects the stream channel to control. (RO)	1.00 Expert
Fire Test Packet	GevSCPSFireTestPacket	When this feature is set to True, the device will fire one test packet.	1.00 Invisible
MAC Address	GevMACAddress	MAC address of the network interface. (RO)	1.00 Invisible
Current Camera IP Configuration  <i>LLA</i>  <i>DHCP</i>  <i>PersistentIP</i>	  <i>LLA</i>  <i>DHCP</i>  <i>PersistentIP</i>	Current camera IP configuration of the selected interface. (RO)  <i>Link-Local Address Mode</i>  <i>Dynamic Host Configuration Protocol Mode. Network requires a DHCP server.</i>  <i>Persistent IP Mode (static)</i>	1.00 Invisible
Persistent IP Address	GevPersistentIPAddress	Persistent IP address for the selected interface. This is the IP address the camera uses when booting in Persistent IP mode.	1.00 Invisible
Persistent Subnet Mask	GevPersistentSubnetMask	Persistent subnet mask for the selected interface.	1.00 Invisible
Persistent Default Gateway	GevPersistentDefaultGateway	Persistent default gateway for the selected interface.	1.00 Invisible
Primary Application Socket	GevPrimaryApplicationSocket	Returns the UDP (User Datagram Protocol) source port of the primary application. (RO)	1.00 Invisible
Device Access Privilege Control  <i>Open Access</i>  <i>Exclusive Access</i>  <i>Control Access</i>	  <i>OpenAccess</i>  <i>ExclusiveAccess</i>  <i>ControlAccess</i>	Controls the device access privilege of an application.  <i>OpenAccess</i>  <i>Grants exclusive access to the device to an application. No other application can control or monitor the device.</i>  <i>Grants control access to the device to an application. No other application can control the device.</i>	1.00 Invisible
Interface Selector	GevInterfaceSelector	Selects which physical network interface to control.	1.00 Invisible

Number Of Interfaces	GevNumberOfInterfaces	Indicates the number of physical network interfaces supported by this device. (RO)	1.00 Invisible
Message Channel Count	GevMessageChannelCount	Indicates the number of message channels supported by this device. (RO)	1.00 Invisible
Stream Channel Count	GevStreamChannelCount	Indicates the number of stream channels supported by this device (0 to 512). (RO)	1.00 Invisible
Gev Supported Option Selector	GevSupportedOptionSelector	Selects the GEV option to interrogate for existing support. (RO)	1.00 Invisible
	<i>IPConfigurationLLA  IPConfigurationDHCP  IPConfigurationPersistentIP  StreamChannelSourceSocket  MessageChannelSourceSocket  CommandsConcatenation  WriteMem  PacketResend  Event  EventData  PendingAck  Action  PrimaryApplicationSwitchover  ExtendedStatusCodes  DiscoveryAckDelay  DiscoveryAckDelayWritable  TestData  ManifestTable  CCPApplicationSocket  LinkSpeed  HeartbeatDisable  SerialNumber  UserDefinedName  StreamChannelOBigAndLittleEndian  StreamChannelOIPReassembly  StreamChannelOUnconditionalStreaming  StreamChannelOExtendedChunkData</i>		
Gev Supported Option	GevSupportedOption	Returns TRUE if the selected GEV option is supported. (RO)	1.00 Invisible
LLA Supported	GevSupportedIPConfigurationLLA	Indicates if LLA (Auto-IP) is supported by the selected interface. The LLA method automatically assigns the camera with a randomly chosen address on the 169.254.xxx.xxx subnet. After an address is chosen, the link-local process sends an ARP query with that IP onto the network to see if it is already in use. If there is no response, the IP is assigned to the device, otherwise another IP is selected, and the ARP is repeated. Note that LLA is unable to forward packets across routers. LLA is the recommended scheme when only one NIC is connected to GigE cameras; ensure only one NIC is using LLA on your PC, otherwise IP conflicts will result. (RO)	1.00 Invisible
DHCP Supported	GevSupportedIPConfigurationDHCP	Indicates if DHCP is supported by the selected interface. This IP configuration mode requires a DHCP server to allocate an IP address dynamically over the range of some defined subnet. The camera must be configured to have DHCP enabled. This is the factory default settings. The DHCP server is part of a managed network. Windows itself does not provide a DHCP server function therefore a dedicated DHCP server is required. The DALSA Network Configuration Tool can be configured as a DHCP server on the NIC used for the GigE Vision network. (RO)	1.00 Invisible

Persistent IP Supported	GevSupportedIPConfigurationPersistentIP	Indicates if Persistent IP is supported by the selected interface. This protocol is only suggested if the user fully controls the assignment of IP addresses on the network and a GigE Vision camera is connected beyond routers. The GigE Vision camera is forced a static IP address. The NIC IP address must use the same subnet otherwise the camera is not accessible. If the camera is connected to a network with a different subnet, it cannot be accessed. (RO)	1.00 Invisible
GVCP Extended Status Codes	GevGVCPExtendedStatusCodes	Enables generation of extended status codes. (RO)	1.00 Invisible
Gev MCP HostPort	GevMCPHostPort	Indicates the port to which the device must send messages. (RO)	1.00 Invisible
Gev MCDA	GevMCDA	Indicates the destination IP address for the message channel. (RO)	1.00 Invisible
Gev MCSP	GevMCSP	This feature indicates the source port for the message channel. (RO)	1.00 Invisible
Stream Channel Interface Index	GevSCPInterfaceIndex	Index of network interface. (RO)	1.00 Invisible
Gev SCP HostPort	GevSCPHostPort	Indicates the port to which the device must send the data stream. (RO)	1.00 Invisible
Gev SCDA	GevSCDA	Indicates the destination IP address for this stream channel. (RO)	1.00 Invisible
Gev SCSP	GevSCSP	Indicates the source port of the stream channel. (RO)	1.00 Invisible
Gev First URL	GevFirstURL	Indicates the first URL to the XML device description file. (RO)	1.00 Invisible
Gev Second URL	GevSecondURL	Indicates the second URL to the XML device description file. (RO)	1.00 Invisible
Gev Major Version	GevVersionMajor	Major version of the specification. (RO)	1.00 Invisible
Gev Minor Version	GevVersionMinor	Minor version of the specification. (RO)	1.00 Invisible
Manifest Entry Selector	DeviceManifestEntrySelector	Selects the manifest entry to reference.	1.00 Invisible
XML Major Version	DeviceManifestXMLMajorVersion	Indicates the major version number of the XML file of the selected manifest entry. (RO)	1.00 Invisible
XML Minor Version	DeviceManifestXMLMinorVersion	Indicates the Minor version number of the XML file of the selected manifest entry. (RO)	1.00 Invisible
XML SubMinor Version	DeviceManifestXMLSubMinorVersion	Indicates the SubMinor version number of the XML file of the selected manifest entry. (RO)	1.00 Invisible
Schema Major Version	DeviceManifestSchemaMajorVersion	Indicates the major version number of the Schema file of the selected manifest entry. (RO)	1.00 Invisible
Schema Minor Version	DeviceManifestSchemaMinorVersion	Indicates the minor version number of the Schema file of the selected manifest entry. (RO)	1.00 Invisible
Manifest Primary URL	DeviceManifestPrimaryURL	Indicates the first URL to the XML device description file of the selected manifest entry. (RO)	1.00 Invisible
Manifest Secondary URL	DeviceManifestSecondaryURL	Indicates the second URL to the XML device description file of the selected manifest entry. (RO)	1.00 Invisible
Device Mode Is Big Endian	GevDeviceModeIsBigEndian	Endianess of the device registers. (RO)	1.00 Invisible
Device Mode CharacterSet	GevDeviceModeCharacterSet	Character set used by all the strings of the bootstrap registers. (RO)	1.00 Invisible

		<i>reserved1 UTF8 reserved2</i>	
GevSCPSDoNotFragment	GevSCPSDoNotFragment	This feature state is copied into the "do not fragment" bit of IP header of each stream packet. (RO)	1.00 Invisible
Gev SCPS BigEndian	GevSCPSBigEndian	Endianess of multi-byte pixel data for this stream. (RO)	1.00 Invisible
TLPParamsLocked	TLPParamsLocked	Flag to indicate if features are locked during acquisition.	1.00 Invisible

## Defaults for devicePacketResendBufferSize

The default minimum for devicePacketResendBufferSize allows at least one maximum sized buffer + metadata in memory.

The formula is:

- $\text{packetResendBufferSizeMax} = (\text{Backend Frame Buffer Memory}) - ((\text{SensorWidth} * \text{SensorHeight} * \text{pixelSize}) + \text{end-of-line metadata})$ .

Note that SensorHeight is the virtual frame Height. The value allowed to change dynamically is pixelSize. The values SensorWidth and SensorHeight are used because the Width and Height values can change if binning is used or even while grabbing.

## Device UPnP Auto-Discovery Mode Details

The Linea GigE supports UPnP Network Auto-Discovery (*Universal Plug and Play*), thus allowing other devices on the network to find and access the camera. This section describes the Windows configuration required for UPnP Auto-Discovery, accessing the Linea GigE web page and file access to user accessible memory on the camera.

### **Enable Windows Network Discovery**

These instructions apply to Windows 7:

- Go to Control Panel\All Control Panel Items\Network and Sharing Center\Advanced sharing settings.
- Windows shows a menu to configure options for each network profile available on that computer.
- Most systems used with the Linea GigE will have a second NIC for the camera, therefore the **Public** profile needs to be configured. Expand the options view for **Public**.
- Enable Network Discovery if it is off, then save your change.

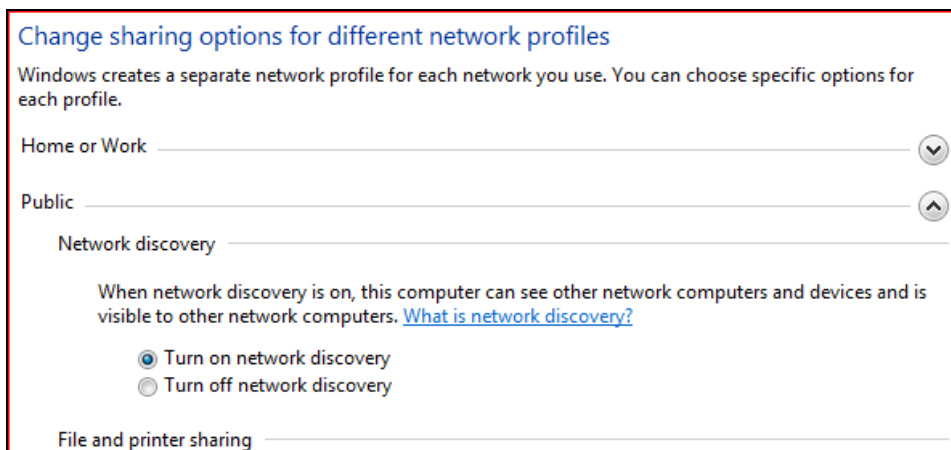

- With Windows Explorer, click on Network where the Linea GigE is shown as a camera network device (see the following screen capture).
- Note that the discovery process is usually fast but may take up to 10 seconds (tested on a Windows 7 pc) and this delay must be accounted for by any application activating the *deviceUPnPDiscoveryMode* feature.

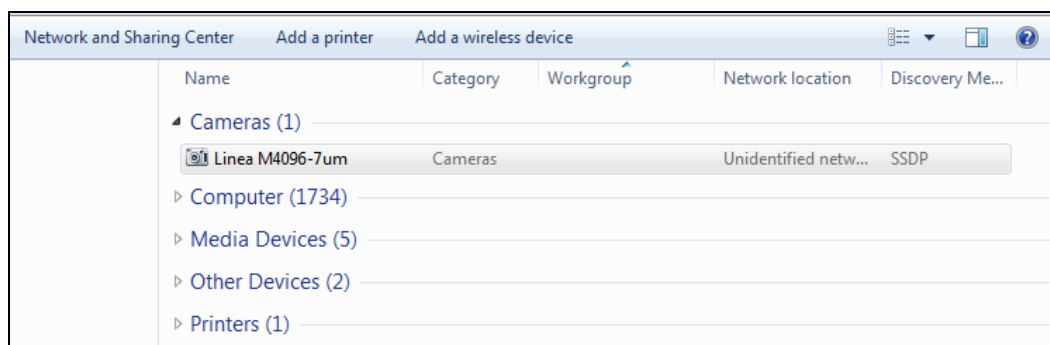



## Accessing the Linea GigE File Memory

- Double-click the Linea GigE icon to access the camera home page as shown below (Windows IE is used as the default browser).

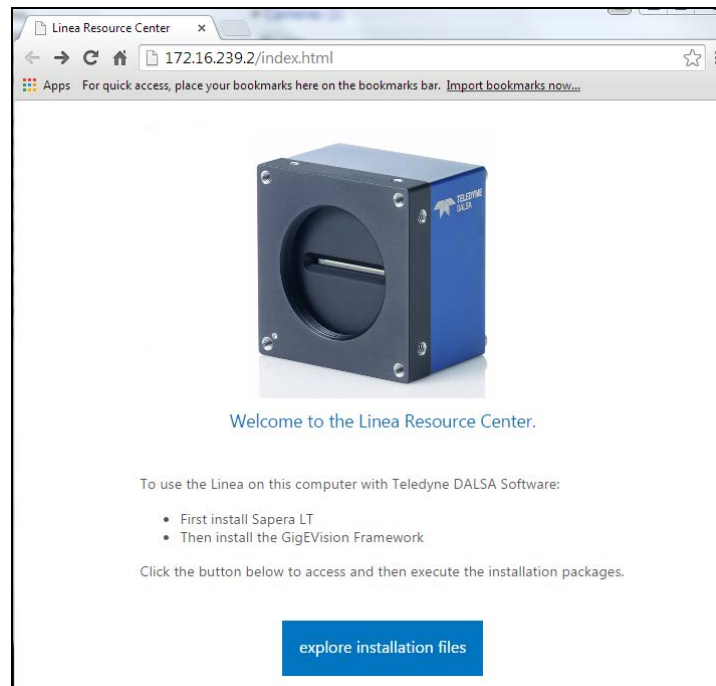

- The Linea GigE home page presents a short welcome message. Click on the file access button to open an ftp client session, but currently there are no files distributed in the camera. Please go to the [Teledyne DALSA support web site](#) to download the latest Sapera LT and Linea GigE firmware.

## Using the Linea GigE File Memory

Any or all of the Linea GigE file memory is usable by the user to store data. Folders can be created and files copied to the camera (limited to available space). Any factory distribution files or folders can be deleted to free additional memory.

To use available memory:

- From the ftp access window (see previous screen capture) open the View drop menu and click *Open FTP Site in Windows Explorer*.
- Perform any file or folder operation as required. Close the Windows Explorer window when done.
- From the open FTP access window, click the refresh button to view changes. **Note:** The refresh button must be clicked for each folder level to view any changes made.

## GigE Vision Host Control Category

The GigE Vision Host controls, as shown by CamExpert, group parameters used to configure the host computer system GigE Vision features used for Linea GigE networking management. None of these parameters are stored in any Linea GigE camera.

These features allow optimizing the network configuration for maximum bandwidth. Settings for these parameters are highly dependent on the number of cameras connected to a NIC, the data rate of each camera and the trigger modes used.

Information on these features is found in the Teledyne DALSA Network Imaging Module User manual.

## File Access Control Category

The File Access control in CamExpert allows the user to quickly upload various data files to the connected Linea GigE. The supported data files are for Linea GigE firmware updates and Flat Field coefficients.

Features listed in the description table but tagged as *Invisible* are usually for Teledyne DALSA or third party software usage—not typically needed by end user applications.

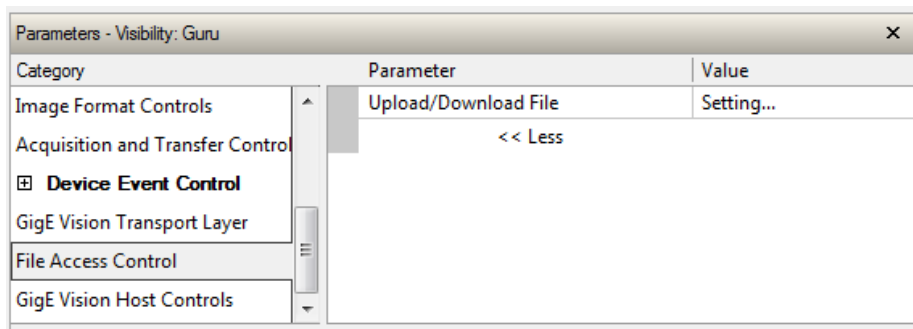

## File Access Control Feature Descriptions

The Device Version number represents the camera software functional group, not a firmware revision number. As Linea GigE capabilities evolve the device version tag will increase, therefore identifying the supported function package. New features for a major device version release will be indicated by green text for easy identification.

Display Name	Feature & Values	Description	Device Version & View
File Selector	FileSelector	Selects the file to access. The file types which are accessible are device-dependent.	1.00 Guru
<i>Firmware</i>	<i>Firmware1</i>	<i>Upload new firmware to the camera which will execute on the next camera reboot cycle. Select the DeviceReset feature after the upload completes.</i>	
<i>Factory FlatField coefficients</i>	<i>FlatFieldCoefficients0</i>	<i>Select factory flatfield coefficients1. These are the factory values used when the camera sensor Gain is 1.0.</i>	

<p>User FlatField coefficients 1 to User FlatField coefficients 4</p> <p>User LUT 1 to User LUT 8</p> <p>NoCorrectionFactory</p> <p>WhiteLEDFactory</p> <p>Matrix User Set 1</p> <p>Matrix User Set 2</p> <p>Future Use File</p> <p>User Defined Pattern Image</p> <p>User Defined Saved Image</p>	<p>FlatFieldCoefficients1 to FlatFieldCoefficients4</p> <p>LutLuminance1 to LutLuminance8</p> <p>ColorCorrectionMatrix0</p> <p>ColorCorrectionMatrix1</p> <p>ColorCorrectionMatrix2</p> <p>ColorCorrectionMatrix3</p> <p>futureUseFile</p> <p>userDefinedPatternImage</p> <p>userDefinedSavedImage</p>	<p>Select to read (download), write (upload) the User flatfield coefficients #.</p> <p>User LUT #</p> <p>Color Matrix file: NoCorrectionFactory</p> <p>Color Matrix file: WhiteLEDFactory</p> <p>Color Matrix file: Matrix User Set 1</p> <p>Color Matrix file: Matrix User Set 2</p> <p>Upload a cross talk correction file to the camera.</p> <p>Upload an user defined image into the camera.</p> <p>Upload and download an image in the camera.</p>	
<p>File Operation Selector</p> <p>Open</p> <p>Close</p> <p>Read</p> <p>Write</p> <p>Delete</p>	<p>FileOperationSelector</p> <p>Open</p> <p>Close</p> <p>Read</p> <p>Write</p> <p>Delete</p>	<p>Selects the target operation for the selected file in the device. This operation is executed when the File Operation Execute feature is called.</p> <p>Select the Open operation - executed by FileOperationExecute.</p> <p>Select the Close operation - executed by FileOperationExecute</p> <p>Select the Read operation - executed by FileOperationExecute.</p> <p>Select the Write operation - executed by FileOperationExecute.</p> <p>Select the Delete operation - executed by FileOperationExecute.</p>	<p>1.00 Guru</p>
<p>File Operation Execute</p>	<p>FileOperationExecute</p>	<p>Executes the operation selected by File Operation Selector on the selected file.</p>	<p>1.00 Guru</p>
<p>File Open Mode</p> <p>Read</p> <p>Write</p>	<p>FileOpenMode</p> <p>Read</p> <p>Write</p>	<p>Selects the access mode used to open a file on the device.</p> <p>Select READ only open mode</p> <p>Select WRITE only open mode</p>	<p>1.00 Guru</p>
<p>File Access Buffer</p>	<p>FileAccessBuffer</p>	<p>Defines the intermediate access buffer that allows the exchange of data between the device file storage and the application.</p>	<p>1.00 Guru</p>
<p>File Access Offset</p>	<p>FileAccessOffset</p>	<p>Controls the mapping offset between the device file storage and the file access buffer.</p>	<p>1.00 Guru</p>
<p>File Access Length</p>	<p>FileAccessLength</p>	<p>Controls the mapping length between the device file storage and the file access buffer.</p>	<p>1.00 Guru</p>
<p>File Operation Status</p> <p>Success</p> <p>Failure</p> <p>File Unavailable</p> <p>File Invalid</p>	<p>FileOperationStatus</p> <p>Success</p> <p>Failure</p> <p>FileUnavailable</p> <p>FileInvalid</p>	<p>Displays the file operation execution status. (RO)</p> <p>The last file operation has completed successfully.</p> <p>The last file operation has completed unsuccessfully for an unknown reason.</p> <p>The last file operation has completed unsuccessfully because the file is currently unavailable.</p> <p>The last file operation has completed unsuccessfully because the selected file is not present in this camera model.</p>	<p>1.00 Guru</p>
<p>File Operation Result</p>	<p>FileOperationResult</p>	<p>Displays the file operation result. For Read or Write operations, the number of successfully read/written bytes is returned. (RO)</p>	<p>1.00 Guru</p>
<p>File Size</p>	<p>FileSize</p>	<p>Represents the size of the selected file in bytes.</p>	<p>1.00 Guru</p>
<p>Device User Buffer</p>	<p>deviceUserBuffer</p>	<p>Unallocated memory available to the user for data storage.</p>	<p>1.00 DFNC Invisible</p>
<p>FTP File Access</p>	<p>ftpFileAccessSupported</p>	<p>Shows whether File Access is supported over FTP.</p>	<p>1.10 DFNC Invisible</p>

## File Access via the CamExpert Tool

- Click on the “Setting...” button to show the file selection menu.

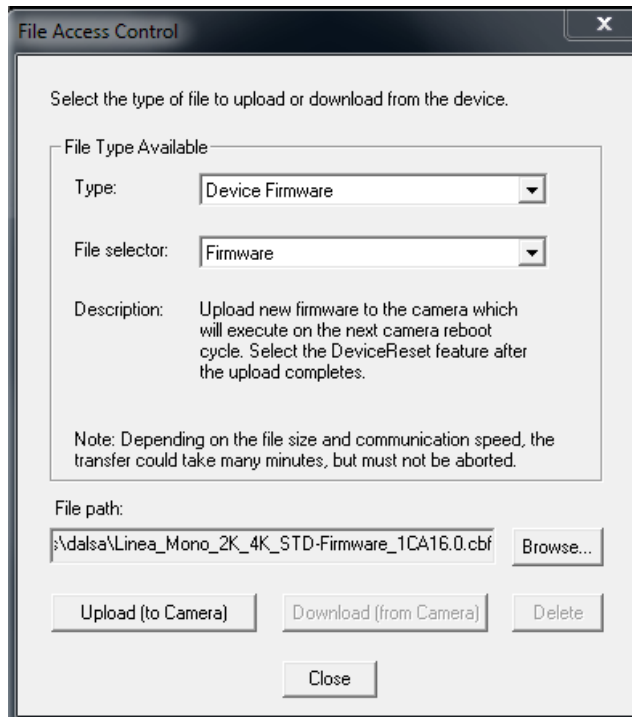

- From the file type drop menu, select the file type that will be uploaded to the Linea GigE. This CamExpert tool allows quick firmware changes or updates.
- From the File Selector drop menu, select the Linea GigE memory location for the uploaded data. This menu presents only the applicable data locations for the selected file type.
- Click the Browse button to open a typical Windows Explorer window.
- Select the specific file from the system drive or from a network location.
- Click the Upload button to execute the file transfer to the Linea GigE.
- Note that firmware changes require a device reset command from the Camera Information Controls.

---

# Device Streaming Registers

## Start – End Command Requirements

**Important:** Every start command must have a corresponding end command. If not, the camera can be in an unpredictable state. This pertains to *DeviceRegistersStreamingStart*, *DeviceRegistersStreamingEnd*, *DeviceFeaturePersistenceStart*, and *DeviceFeaturePersistenceEnd*.

Device Registers Streaming Start	DeviceRegistersStreamingStart	Announces the start of registers streaming without immediate checking for consistency.	1.00 Invisible
Device Registers Streaming End	DeviceRegistersStreamingEnd	Announces end of registers streaming and performs validation for registers consistency before activating them.	1.00 Invisible
Device Feature Streaming Start	DeviceFeaturePersistenceStart	Announces the start of feature streaming without immediate checking for consistency.	1.00 Invisible
Device Feature Streaming End	DeviceFeaturePersistenceEnd	Announces end of feature streaming and performs validation for feature consistency before activating them.	1.00 Invisible
Register Check	DeviceRegistersCheck	Performs an explicit register set validation for consistency.	1.00 Invisible
Registers Valid	DeviceRegistersValid	States if the current register set is valid and consistent.	1.00 Invisible

# Network Overview & Tools

---

## IP Configuration Mode Details

The following descriptions provide more information on the IP configuration modes supported by Linea GigE. In general automatic IP configuration assignment (LLA/DHCP) is sufficient for most installations.

Please refer to the Teledyne DALSA Network Imaging Package manual for information on the Teledyne DALSA Network Configuration tool and network optimization for GigE Vision cameras and devices.

### Link-Local Address (LLA)

- LLA is also known as Auto-IP. It is used for unmanaged networks including direct connections from a GigE Vision device to a dedicated NIC.
- A subnet configured with LLA cannot send packets across routers but only via Ethernet switches.
- LLA is the recommended scheme when only one NIC is connected to GigE cameras. LLA is fully automatic requiring no user input.
  - 📘 Ensure only one NIC is using LLA on your PC, otherwise IP conflicts will result.
- The NIC will automatically assign a random IP address within the 169.254.x.x subnet. The LLA protocol ensures there are no conflicts with other devices through an arbitration scheme.
- The Windows NIC configuration must be set to DHCP (the typical default case) and no DHCP server must be present on the network. Otherwise, an IP address gets assigned by the DHCP server. Windows will turn to LLA when no DHCP server answers requests coming from the NIC.
- Windows and Linea GigE are still running the DHCP process in the background. If a DHCP server becomes available on the network, the NIC will get a DHCP assigned IP address for the connected device but connections on the LLA IP address will be lost. The Teledyne DALSA Network Configuration Tool can enable the Teledyne DALSA DHCP server on the NIC used for the GigE Vision network.
- Important: If the host system has multiple NIC devices configured with LLA, then the communication stack cannot accurately resolve which NIC to forward an IP packet on the 169.254 segment. Limit the number of NIC configured using LLA to one interface. It is preferable that the Teledyne DALSA DHCP server is used instead of LLA mode (see next section).
- Use the Teledyne DALSA Network Configuration Tool to change the Linea GigE from the default DHCP/LLA mode to Persistent IP mode when required, such as when there are multiple NIC devices with Linea GigE connected to each. Note that Teledyne DALSA recommends DHCP/LLA as the mode of operation where a switch is used to connect multiple devices.

## DHCP (Dynamic Host Configuration Protocol)

- This IP configuration mode requires a DHCP server to allocate an IP address dynamically over the range of some defined subnet. The Linea GigE camera must be configured to have DHCP enabled. This is the factory default setting.
- The DHCP server is part of a managed network. Windows itself does not provide a DHCP server function therefore a dedicated DHCP server is required. The Teledyne DALSA Network Configuration Tool can configure the Teledyne DALSA DHCP server on the NIC used for the GigE Vision network.
- The Teledyne DALSA DHCP server is recommended where there are multiple NIC ports with multiple GigE Vision devices attached. Each NIC port must use a different subnet to avoid IP address conflicts. Persistent IP assignment is required if there is no DHCP server for any additional subnet.
- Under Windows, a NIC is configured in DHCP mode by default. If no DHCP server is present on a given subnet, Windows will revert to LLA as explained in the section above.
- Ensure that a different subnet is assigned to each NIC on the network. This will automatically be managed correctly when the Teledyne DALSA DHCP server is enabled on one or all subnets used for GigE Vision devices. The graphic below illustrates a system with one NIC having the Teledyne DALSA DHCP server enabled.

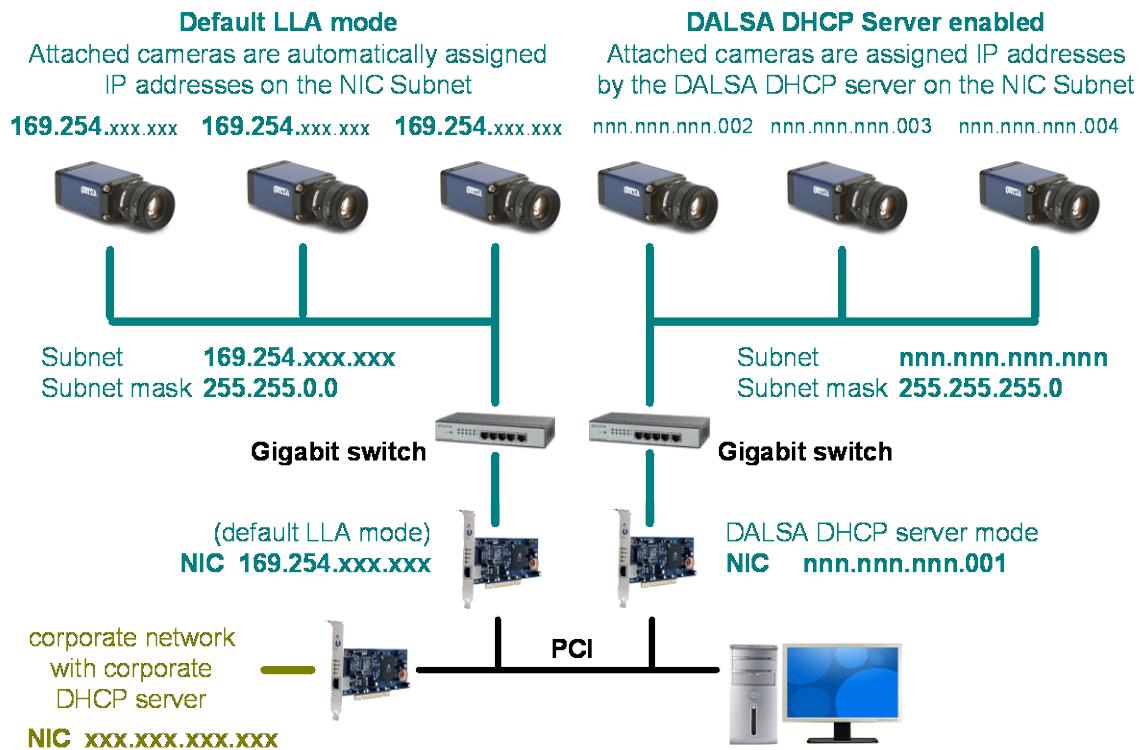

## Persistent IP

- This configuration is only suggested if the user fully controls the assignment of IP addresses on the network.
- The GigE Vision camera is forced a static IP address. The NIC IP address must use the same subnet otherwise the camera is not accessible.
- If the Linea GigE camera is connected to a network with a different subnet, it cannot be accessed.
- The Teledyne DALSA Network Configuration Tool is used to set a persistent IP address. Refer to the Teledyne DALSA Network Imaging manual.
- An example of a Persistent IP address assignment on a class B network:
  - NIC Subnet = 192.168.1.1
  - Subnet Mask = 255.255.0.0
  - Persistent IP = 192.168.1.2
  - Default Gateway = 0.0.0.0
- Warning: an incorrect IP address assignment might make it impossible to connect to the camera. In such a case the Teledyne DALSA Network Configuration tool includes a function to recover a Linea GigE camera with an unknown persistent IP and set the camera to the factory default setting, i.e. DHCP/LLA mode. The camera MAC address must be known to use this function.
- For GigE Vision applications the FORCEIP command is used to force a new persistent IP or to change the IP configuration protocol. The Linea GigE MAC address must be known to use the FORCEIP command.
- The following illustration shows a functional computer setup with three NIC ports, but no DHCP server. Two NIC ports are used for private GigE Vision networks. The first uses the default LLA mode for IP addresses, while the second NIC and the cameras connected to it are configured with persistent IP addresses. An application on the computer can control each camera, on each subnet, without conflict.



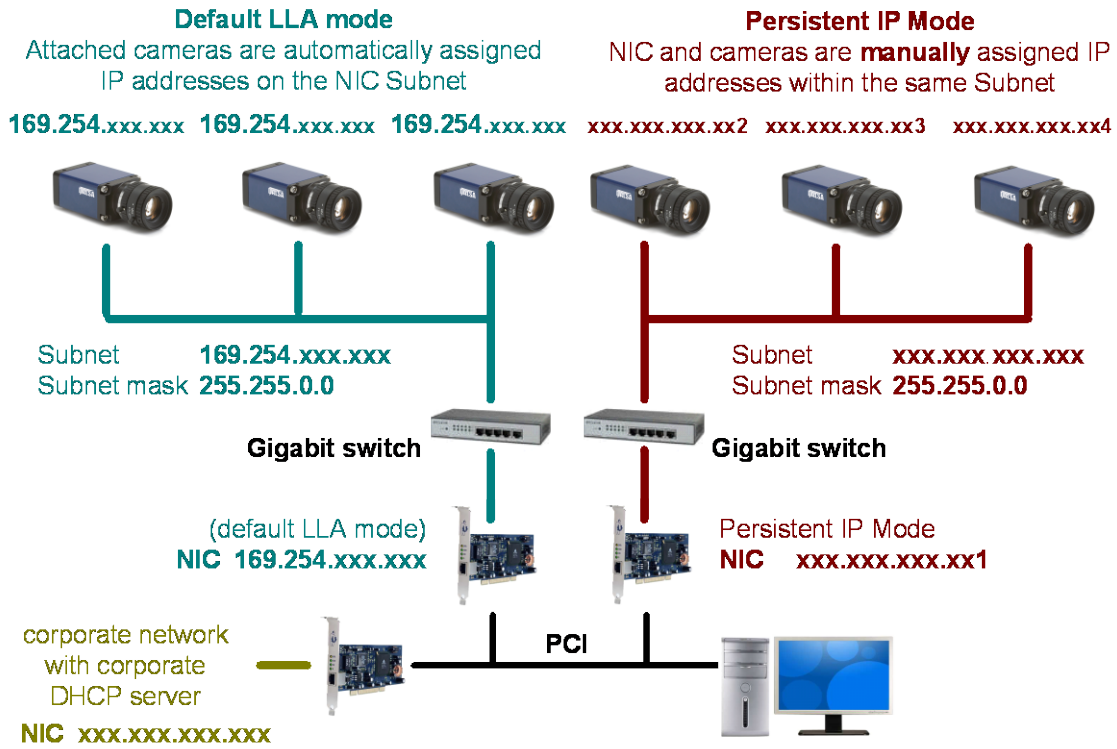

# Technical Specifications

## Mechanical Specifications

### Linea Color GigE 2k and 4k

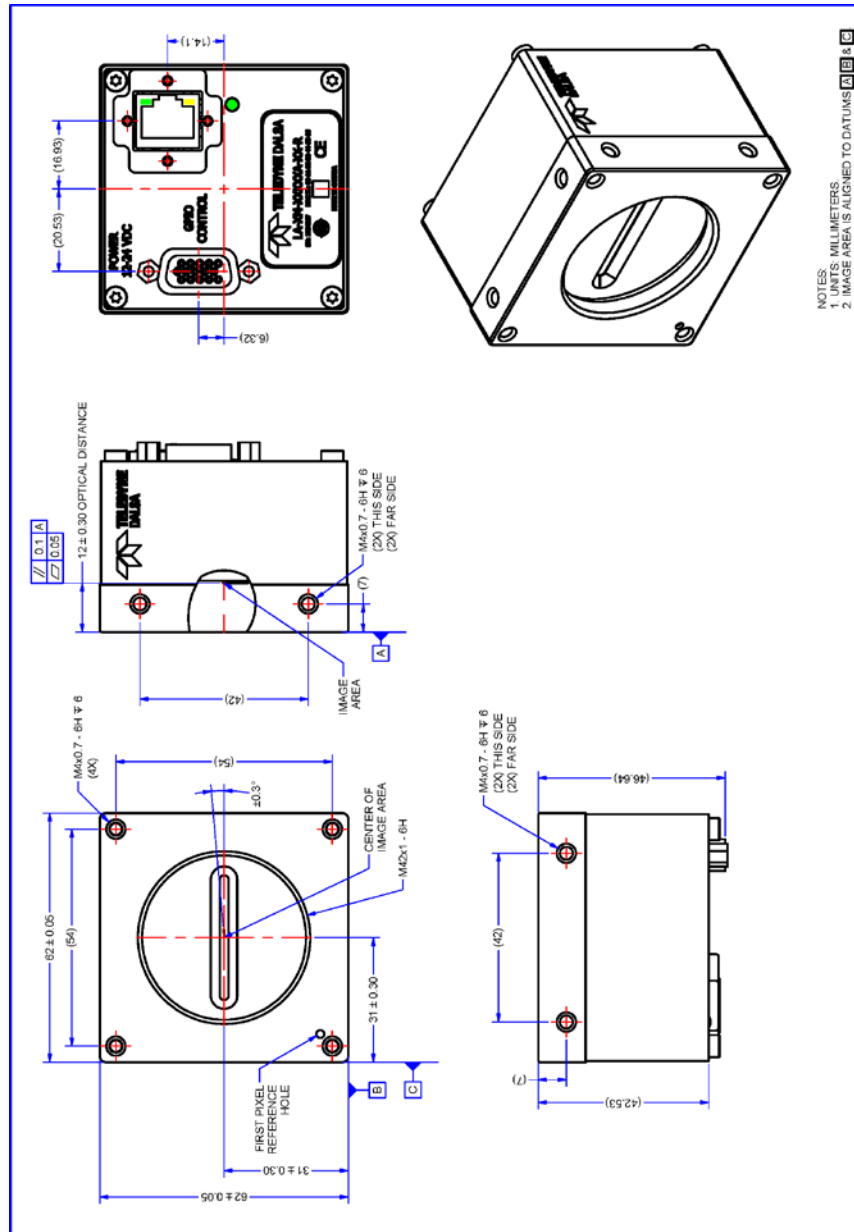

Note: Linea GigE 2k/4k with M42x1 Lens Mount

# Additional Notes on Linea GigE Identification and Mechanical

## Identification Label

	<p>Linea GigE cameras have an identification label applied to the back side, with the following information:</p> <ul style="list-style-type: none"> <li>Model Part number</li> <li>Serial number</li> <li>MAC ID</li> <li>2D Barcode</li> <li>CE and FCC logo</li> <li>"Made in Canada" Statement</li> </ul>
---	--

## Additional Mechanical Notes

	<p>Linea GigE supports a screw lock Ethernet cable (see Ruggedized RJ45 Ethernet Cables). For information on lens requirements see Lens Selection Overview and Optical Considerations. Each camera side has two mounting holes in identical locations, which provide good grounding capabilities. Overall height or width tolerance is <math>\pm 0.05\text{mm}</math>.</p>
---	--

# Sensor Alignment Specification

The following figure specifies sensor alignment for Linea GigE where all specifications define the absolute maximum tolerance allowed for production cameras. Dimensions "x, y, z", are in microns and referenced to the Linea GigE mechanical body or the optical focal plane (for the z-axis dimension). Theta specifies the sensor rotation relative to the sensor's center and camera mechanical.

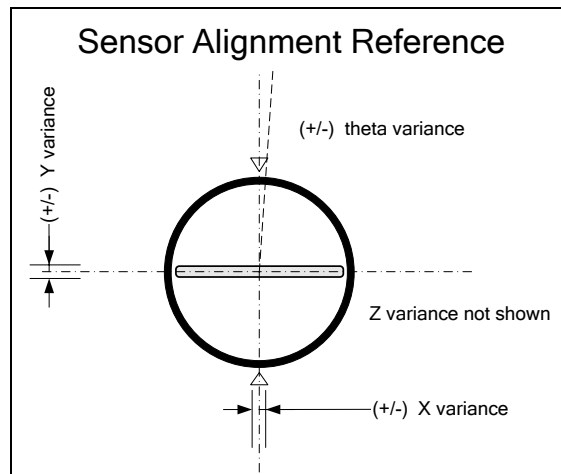

	Linea GigE
X variance	$\pm 300 \mu\text{m}$
Y variance	$\pm 300 \mu\text{m}$
Z variance	$\pm 300 \mu\text{m}$
Theta variance	$\pm 0.3^\circ$

## Connectors

- A single **RJ45 Ethernet** connector for control and video data to the host Gigabit NIC. For industrial environments, Linea GigE supports the use of screw lock Ethernet cables (see "Ruggedized RJ45 Ethernet Cables" on page 131).
- A single **HD15 female** connector for all I/O and DC power source.

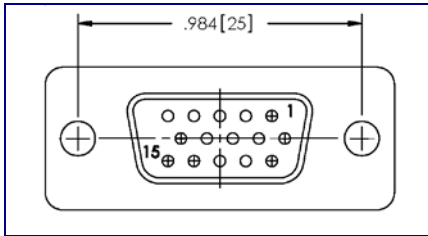

### HD15 type Connector Details

Pin Number	Linea GigE	Direction	Definition
1	Line 1+	In	RS-422/Single ended Input Port 1+
2	Line 1-	In	RS-422 Input Port 1-
3	Line 2+	In	RS-422/Single ended Input Port 2+
4	Line 2-	In	RS-422 Input Port 2-
5	Signals Ground		Signals Ground
6	Line 3+	In/Out	RS-422/Single ended Input <i>or</i> Output Port 3+
7	Line 3-	In/Out	RS-422 Input <i>or</i> Output Port 3-
8	Line 4+	In/Out	RS-422/Single ended Input <i>or</i> Output Port 4+
9	Line 4-	In/Out	RS-422 Input <i>or</i> Output Port 4-
10	PWR-GND		Camera Power Ground
11	Line 5+	Out	RS-422/Single ended Output Port 5+
12	Line 5-	Out	RS-422 Output Port 5-
13	Line 6+	Out	RS-422/Single ended Output Port 6+
14	Line 6-	Out	RS-422 Output Port 6-
15	PWR-VCC	-	Camera Power – DC +12 to +24 Volts

### Mating GPIO Cable Assembly

Teledyne DALSA optionally provides for purchase a GPIO breakout cable (HD15 Male to 26-Pos Euro Block) as shown in the following drawing. Use accessory number #AC-CA-00002-00-R when placing your order.

REVISION HISTORY				
ZONE	REV	DESCRIPTION	DATE	APPROVED
	A	Initial Drawing	3/12/2015	Artur Didyk

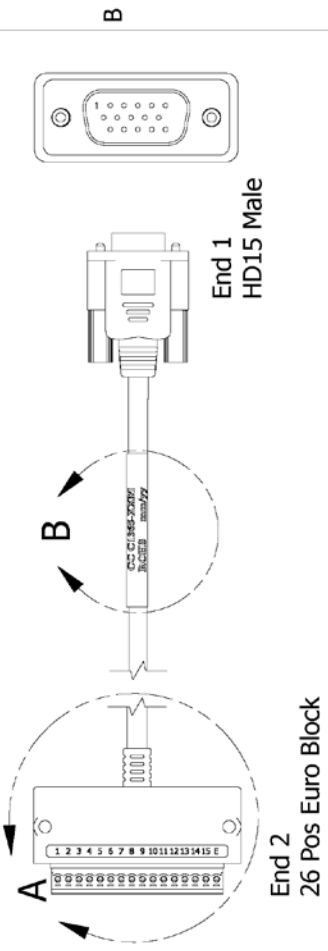
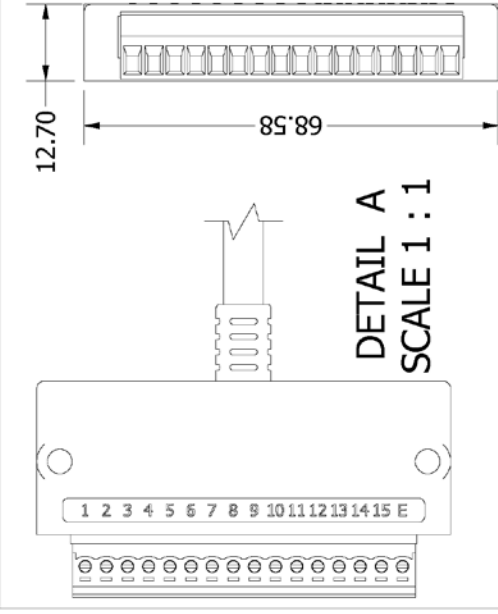

**CC C1365-XXM**  
**ROHS** mm/yy

**DETAIL B**  
**SCALE 2 : 1**

**MUST USE LEAD FREE**  
**SOLDER THROUGHOUT**

TABLE		
End 1	Color Code	End 2
1	WHT/BRN	1
2	BRN/WHT	2
3	WHT/ORG	3
4	ORG/WHT	4
5	WHT/GRY	5
6	GRY/WHT	6
7	WHT/YLW	7
8	YLW/WHT	8
9	WHT/GRN	9
10	GRN/WHT	10
11	WHT/PNK	11
12	PNK/WHT	12
13	TAN/BRN	13
14	WHT/BLU	14
15	BLU/WHT	15
HSG	WHT/VLT	Shield
	VLT/WHT	
	WHT/TAN	
	TAN/WHT	
	BRN/TAN	
	Shield	

DRAWN	1/23/2015	Components Express, Inc.	
CHECKED		TITLE	
QA		HD15 Male to Euro Connector Breakout Cable	
MFG		SIZE	DWG NO
APPROVED		A	CC C1365-XXM
Measurement Units:		SCALE	REV
mm			A
		SHEET 1 OF 1	

# Input Signals Electrical Specifications

## External Inputs Block Diagrams

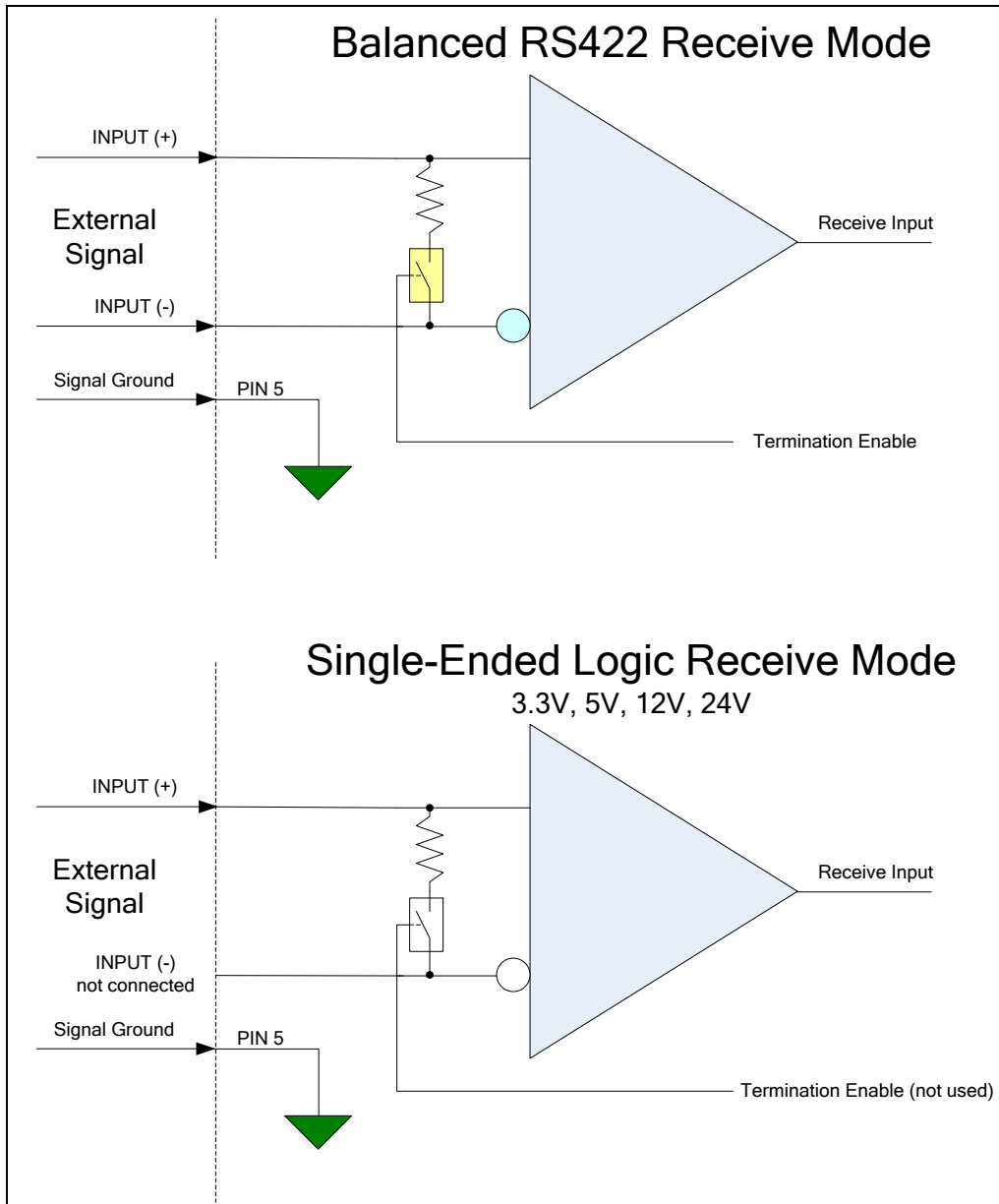

## External Input Overview

- Selectable input trigger threshold levels for RS422 (Differential), 3.3V TTL, 5V TTL, 12V, and 24V single-ended signal inputs (see *lineDetectionLevel* feature). Note that the selected detection level applies to all inputs.
- Used as trigger acquisition event, counter or timestamp event, or integration control.
- User programmable debounce time from 0 to 255 $\mu$ s in 1 $\mu$ s steps.
- **Caution:** It is important to correctly configure external inputs before connecting external signals. Connecting higher voltage signals to inputs configured as RS422 should be avoided, but will not automatically damage the internal termination circuits. The following condition *will* damage the inputs: selecting an RS422 input, grounding the negative RS422 input

(should be floating, if running single ended signals), turning the termination on and then supplying single-ended signals > 5V. This will damage the termination circuits.

### External Input Electrical Characteristics

RS422 Inputs	
Common Mode Input Voltage ( $V_{cm}$ )	-25V min. 25V max.
Differential Input Signal Threshold	$-25V \leq V_{cm} \leq 25V$ ( $\pm 200mV$ )
Differential Input Signal Hysteresis	$V_{cm} = 0V$

Single-Ended Inputs		
	Switching Voltage	
	low to high	high to low
3.3 V TTL	1.5 V	1.5 V
5.0 V TTL	2.5 V	2.5 V
12 V	5 V	5 V
24 V	5 V	5 V

### External Input Timing Reference

Input Level Standard	Maximum Input Frequency	Minimum Pulse Width	Source Current Requirements	Maximum Signal Propagation Delay at 60°C	
				<i>Input Signal Direction</i>	
LVTTTL (3.3V)	20MHz	25ns		0 to 3.3V	<100ns
				3.3V to 0	<100ns
TTL (5.0V)	20MHz	25ns		0 to 5V	<100ns
				5V to 0	<100ns
12V	20MHz	25ns		0 to 12V	<100ns
				12V to 0	<100ns
24V	20MHz	25ns		0 to 24V	<100ns
				24V to 0	<100ns

# Output Signals Electrical Specifications

## External Outputs Block Diagrams

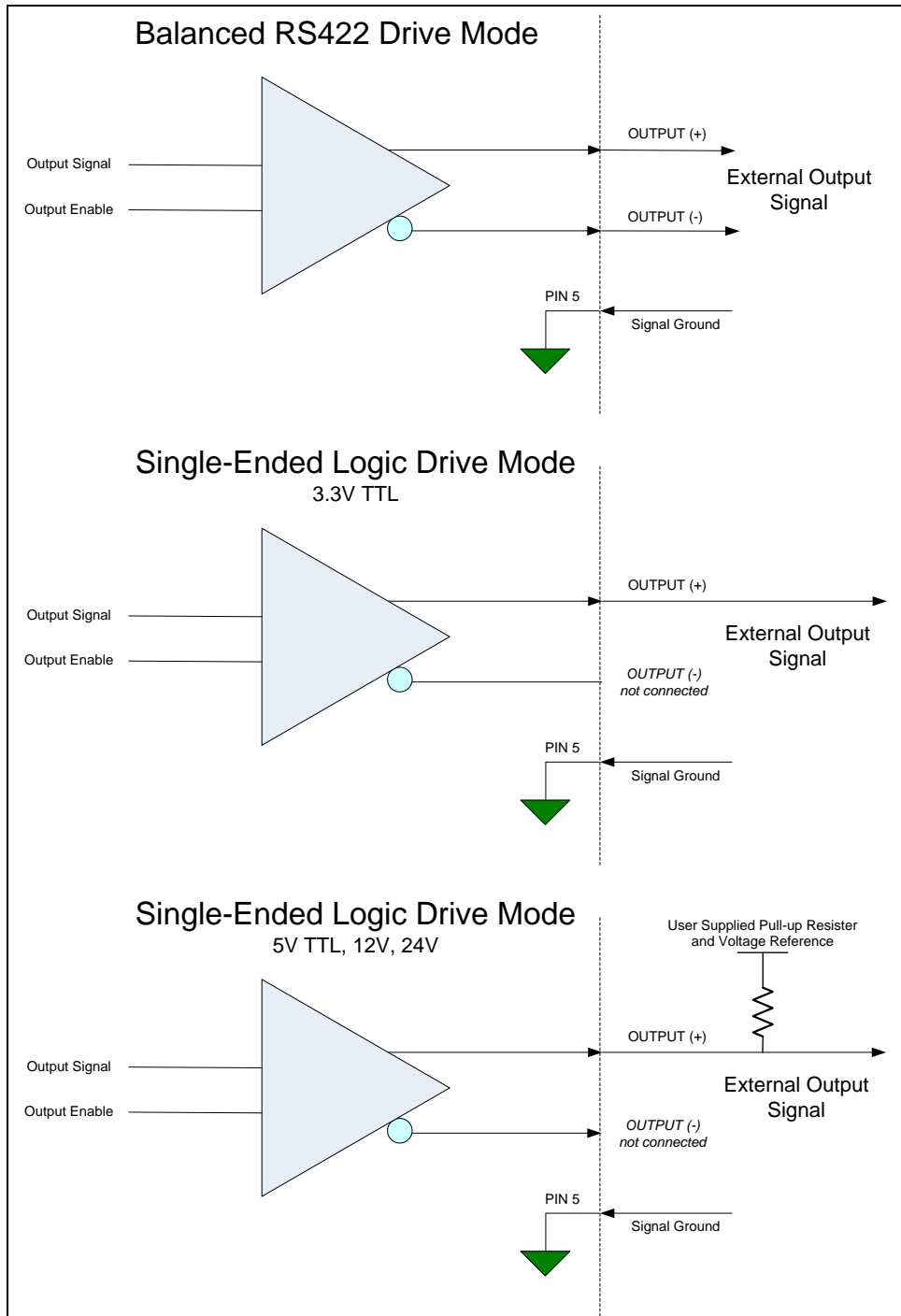

### External Output Details

- Programmable output mode such as strobe, event notification, etc. (see [outputLineSource](#) feature).
- User supplied Pull-up resistor value should be between 1K and 10K depending on supply rail. Resistor Wattage should be calculated accordingly.



- Outputs are open on power-up with the default factory settings
- A software reset will not reset the outputs to the open state if the outputs are active
- A user setup configured to load on boot will not reset the outputs to the open state if the outputs are active
- No output signal glitch on power-up or polarity reversal
- Protection Circuit – DC Ratings:
  - Output protected against shorts to ground or other voltages
  - Output maximum voltage of 26V at 10 mA, (60°C)

---

## Computer Requirements for Linea GigE Cameras

The following information is a guide to computer and networking equipment required to support the Linea GigE camera at maximum performance. The Linea GigE camera series complies with the current IPv4 Internet Protocol, therefore current Gigabit Ethernet (GigE) equipment should provide trouble free performance.

### Host PC System

- Operating System: Windows Vista, Windows 7/8 (either 32-bit or 64-bit for all) are supported.

### Network Adapters

- GigE network adapter (either add on card or on motherboard). The Intel PRO/1000 MT adapter is an example of a high performance NIC. Typically a system will need an Ethernet GigE adapter to supplement the single NIC on the motherboard.
- PCI Express adapters will outperform PCI adapters.
- Network adapters that support Jumbo Frames will outperform adapters with fixed packet size frames. Optimal settings will be system dependent.

### Ethernet Switch Requirements

When there is more than one device on the same network or a camera-to-PC separation greater than 100 meters, an Ethernet switch is required. Since the Linea GigE camera complies with the Internet Protocol, it should work with all standard Ethernet switches. However, switches offer a range of functions and performance grades, so care must be taken to choose the right switch for a particular application.

#### ***IEEE 802.3x Pause Frame Flow Control***

Ethernet Switches supporting Full-duplex IEEE 802.3x Pause Frame Flow Control must be used in situations where multiple cameras may be triggered simultaneously. In such a case the NIC maximum bandwidth would be exceeded if there was no mechanism to temporarily hold back data from cameras. Linea GigE cameras support the IEEE 802.3x pause frame flow control protocol automatically so that images from many cameras can be transmitted through the switch to the NIC efficiently, without data loss. As a working example, one such switch tested at Teledyne DALSA is the NETGEAR GS716T.



**Important:** The maximum virtual frame rate possible from a large number of cameras which are simultaneously triggered will depend on the camera model, frame size, and network configuration. Additionally using Pause Frame may change the Jumbo Frame value which maximizes data throughput. Each imaging system should be tested for data rate maximums.

## **Ethernet to Fiber-Optic Interface Requirements**

In cases of camera-to-PC separations of more than 100 meters but an Ethernet switch is not desired, a fiber-optic media converter can be used. The FlexPoint GX from Omnitron Systems ([www.omnitron-systems.com](http://www.omnitron-systems.com)) converts GigE to fiber transmission and vice versa. It supports multimode (MM) fiber over distances of up to 220 m (720 ft.) and single-mode (SM) fiber up to 65 km (40 mi.) with SC, MT-RJ, or LC connector types.

Important: The inclusion in this manual of GigE to fiber-optic converters does not guarantee they will meet specific application requirements or performance. The user must evaluate any supplemental Ethernet equipment.

# EC & FCC Declarations of Conformity



## EC & FCC DECLARATION OF CONFORMITY

We:  
Teledyne DALSA inc.  
605McMurray Road,  
Waterloo, Ontario, Canada,  
N2V 2E9

Declare under sole legal responsibility that the following products conform to the protection requirements of council directive 2004/108/EC (2014/30/EU after April 2016) on the approximation of the laws of member states relating to electromagnetic compatibility and are CE-marked accordingly:

LA-GC-04K05B-00-R  
LA-GC-02K05B-00-R

The products to which this declaration relates are in conformity with the following relevant harmonized standards, the reference numbers of which have been published in the Official Journal of the European Communities:

EN55032 (2012)	Electromagnetic compatibility of multimedia equipment — Emission requirements
EN55011 (2009) with A1(2010)	Industrial, scientific and medical equipment — Radio-frequency disturbance characteristics — Limits and methods of measurement
EN 61326-1 (2013)	Electrical equipment for measurement, control and laboratory use — EMC requirements — Part 1: General requirements
EN 55024 (2010)	Information technology equipment — Immunity characteristics — Limits and methods of measurement

Further declare under our sole legal responsibility that the product listed also conforms to the following international standards:

CFR 47	part 15 (2008), subpart B, for a class A product. Limits for digital devices
ICES-003	Information Technology Equipment (ITE) — Limits and Methods of Measurement
CISPR 11	Industrial, scientific and medical equipment - Radio-frequency disturbance characteristics - Limits and methods of measurement
CISPR 32	Electromagnetic compatibility of multimedia equipment - Emission requirements

Note: this product is intended to be a component of a larger system.

Waterloo, Canada

May 6, 2016

Location

Date

  
Hank Helmond.  
Director, Quality Assurance

# Additional Reference Information

---

## Lens Selection Overview

This section provides a general overview to selecting a lens for the Linea GigE. Mechanical drawings and Teledyne DALSA part numbers for available lens adapters is provided.

The first two lens parameters, Lens Mount and Lens Image Circle, are based on correctly matching the lens to the sensor. Brief information on other lens parameters to consider follows those sections.

## Lens Mount Types

### *Linea GigE 2k and 4k*

Linea GigE 2k and 4k cameras uses a M42x1 lens screw mount and optionally has adapters for F-mount (AC-LA-00115-A1-R ) and C-mount (AC-LC-00001-00-R) lenses, as described below.

**M42x1 to Nikon F Bayonet Adapter (AC LA 00115 A1-R)**

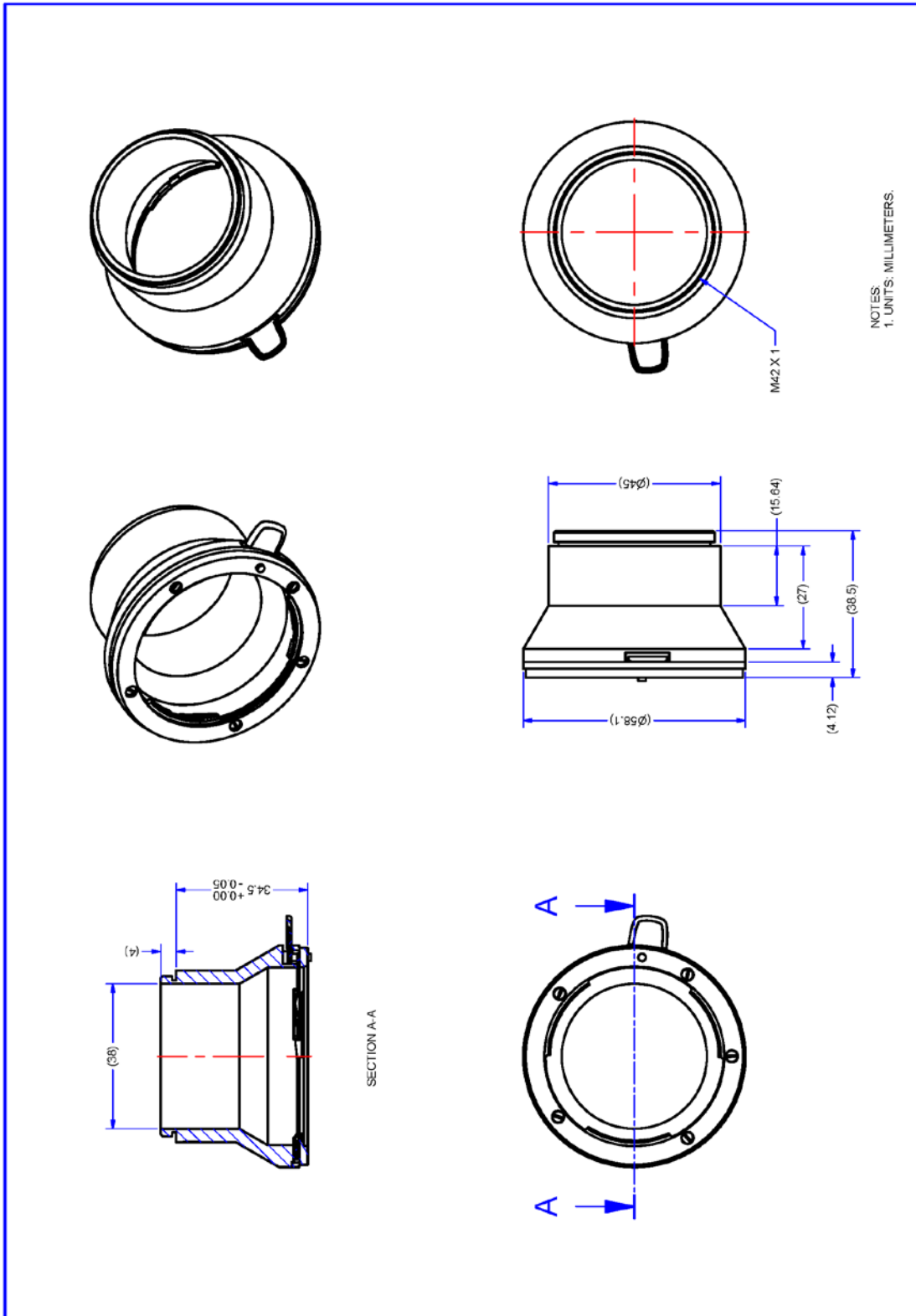

*Nikon F Bayonet to M42x1 Adapter, 12mm BFD, HEAVY DUTY w/clip*

**M42x1 to C-Mount Adapter (AC-LC-00001-00-R)**

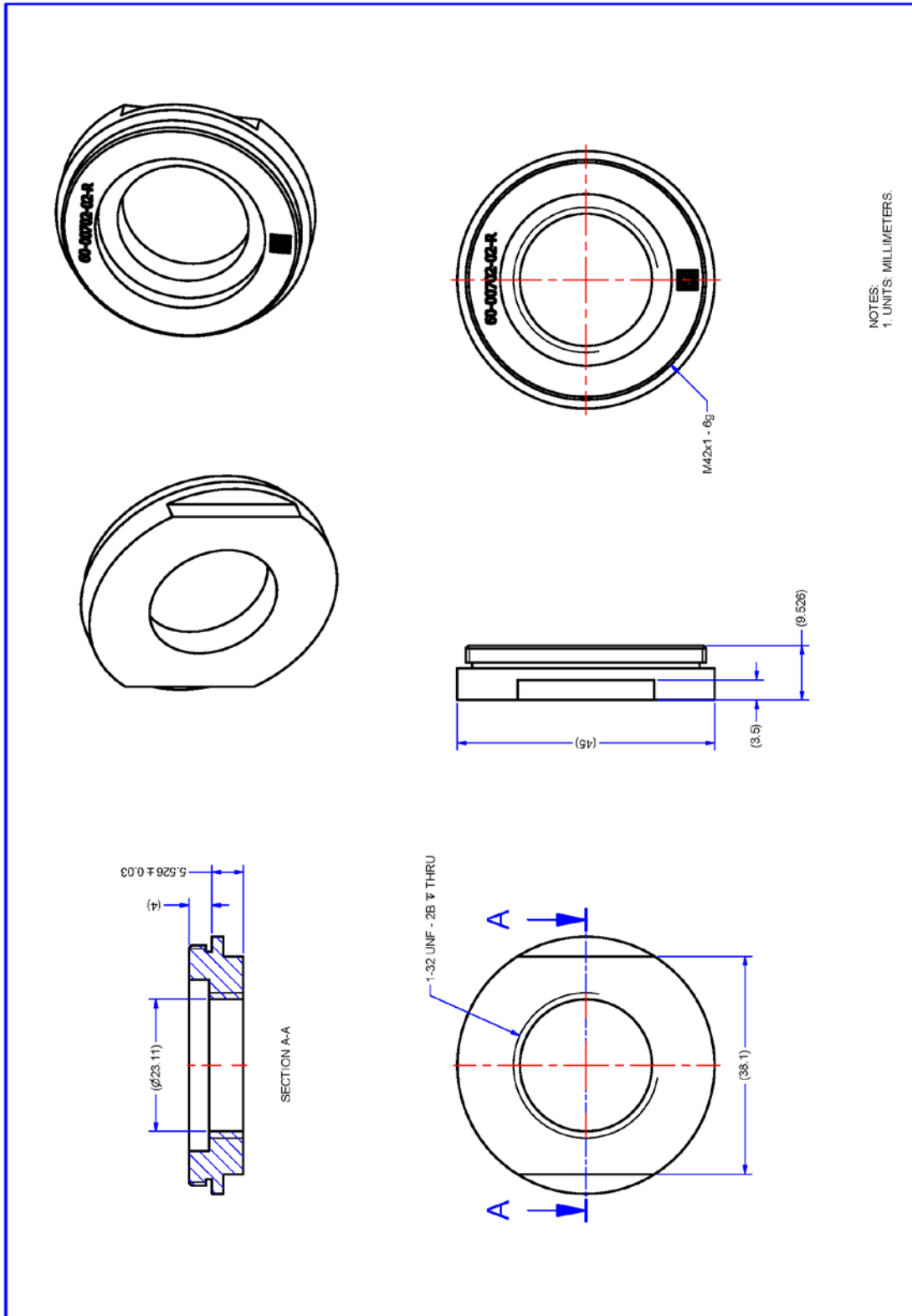

M42 to C-Mount Adapter, 12mm BFD

## Lens Image Circle Illustration

The graphic below illustrates the Linea GigE 2k/4k active sensor relative to the lens image circle.

- The upper graphic compares the Linea GigE 4k relative to a Nikon FDX lens (using the optional F-mount adapter).
- The lower graphic compares the Linea GigE 2k relative to 1.3" and 1" lens (using the optional C-mount adapter).

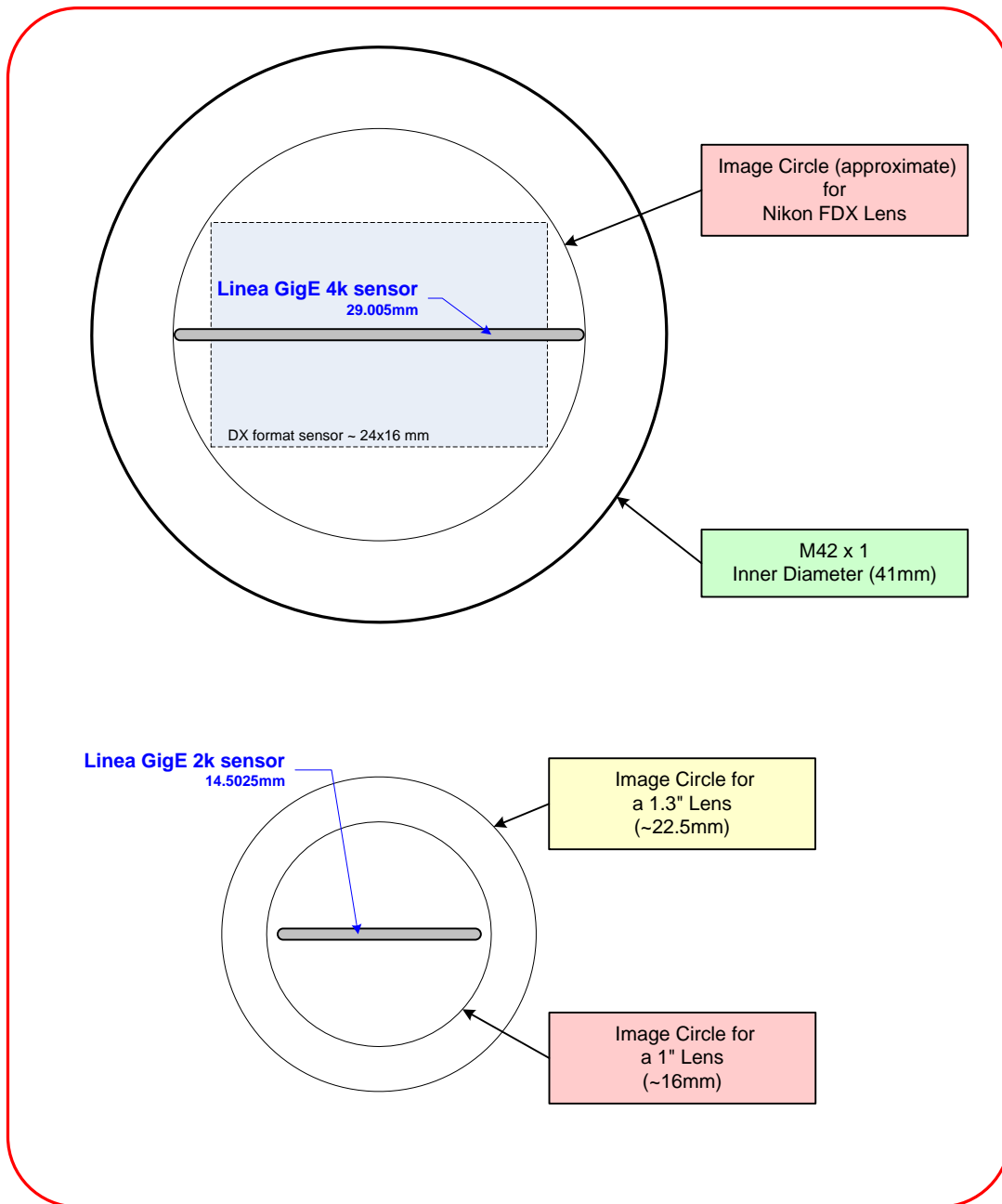

*Lens Image Circle Illustration*

## Additional Lens Parameters (application specific)

There are other lens parameters that are chosen to meet the needs of the vision application. These parameters are independent of the Linea GigE (assuming that the Lens Mount and Lens Sensor Size parameters are correct, as previously covered in this section). A vision system integrator or lens specialist should be consulted when choosing lenses since there is a trade-off between the best lenses and cost. An abridged list of lens parameters follows – all of which need to be matched to the application.

- **Focal Length:** Defines the focus point of light from infinity. See Camera Specifications — Back Focal Distance.
- **Field of View:** A lens is designed to image objects at some limited distance range, at some positive or negative magnification. This defines the field of view.
- **F-Number (aperture):** The lens aperture defines the amount of light that can pass. Lenses may have fixed or variable apertures. Additionally the lens aperture affects Depth of Field which defines the distance range which is in focus when the lens is focus at some specific distance.
- **Image Resolution and Distortion:** A general definition of image quality. A lens with poor resolution seems to never be in focus when used to image fine details.
- **Aberrations (defect, chromatic, spherical):** Aberrations are specific types of lens faults affecting resolution and distortion. Lens surface defects or glass faults distort all light or specific colors. Aberrations are typically more visible when imaging fine details.
- **Spatial Distortions:** Describes non-linear lens distortions across the field of view. Such distortion limits the accuracy of measurements made with that lens.



---

# Optical Considerations

This section provides an overview to illumination, light sources, filters, lens modeling, and lens magnification. Each of these components contributes to the successful design of an imaging solution.

## Illumination

The amount and wavelengths of light required to capture useful images depend on the particular application. Factors include the nature, speed, and spectral characteristics of objects being imaged, exposure times, light source characteristics, environmental and acquisition system specifics, and more. The Teledyne DALSA Web site, <http://mv.dalsa.com/>, provides an introduction to this potentially complicated issue. Click on Knowledge Center and then select Application Notes and Technology Primers. Review the sections of interest.

It is often more important to consider exposure than illumination. The total amount of energy (which is related to the total number of photons reaching the sensor) is more important than the rate at which it arrives. For example,  $5\mu\text{J}/\text{cm}^2$  can be achieved by exposing  $5\text{mW}/\text{cm}^2$  for 1ms just the same as exposing an intensity of  $5\text{W}/\text{cm}^2$  for  $1\mu\text{s}$ .

## Light Sources

Keep these guidelines in mind when selecting and setting up light source:

- LED light sources are relatively inexpensive, provide a uniform field, and longer life span compared to other light sources. However, they also require a camera with excellent sensitivity.
- Halogen light sources generally provide very little blue relative to infrared light (IR).
- Fiber-optic light distribution systems generally transmit very little blue relative to IR.
- Some light sources age such that over their life span they produce less light. This aging may not be uniform—a light source may produce progressively less light in some areas of the spectrum but not others.

## Lens Modeling

Any lens surrounded by air can be modeled for camera purposes using three primary points: the first and second principal points and the second focal point. The primary points for a lens should be available from the lens data sheet or from the lens manufacturer. Primed quantities denote characteristics of the image side of the lens. That is,  $h$  is the object height and  $h'$  is the image height.

The focal point is the point at which the image of an infinitely distant object is brought to focus. The effective focal length ( $f'$ ) is the distance from the second principal point to the second focal point. The back focal length (BFL) is the distance from the image side of the lens surface to the second focal point. The object distance (OD) is the distance from the first principal point to the object.

### Primary Points in a Lens System

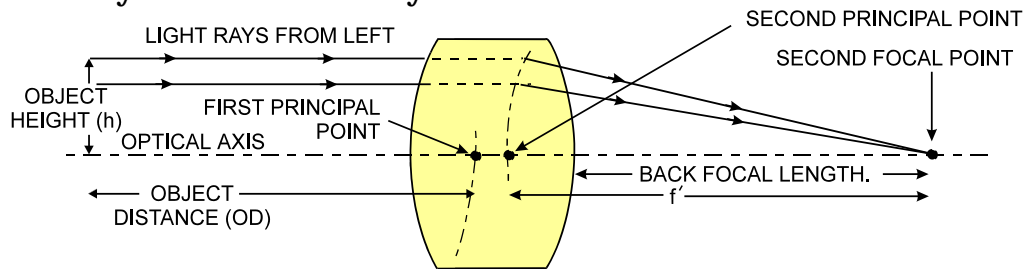

## Magnification and Resolution

The magnification of a lens is the ratio of the image size to the object size:

$m = \frac{h'}{h}$	Where $m$ is the magnification, $h'$ is the image height (pixel size) and $h$ is the object height (desired object resolution size).
--------------------	--

By similar triangles, the magnification is alternatively given by:

$m = \frac{f'}{OD}$
---------------------

These equations can be combined to give their most useful form:

$\frac{h'}{h} = \frac{f'}{OD}$	This is the governing equation for many object and image plane parameters.
--------------------------------	--

**Example:** An acquisition system has a 512 x 512 element, 10 $\mu$ m pixel pitch area scan camera, a lens with an effective focal length of 45mm, and requires that 100 $\mu$ m in the object space correspond to each pixel in the image sensor. Using the preceding equation, the object distance must be 450mm (0.450m).

$\frac{10\mu m}{100\mu m} = \frac{45mm}{OD}$	$OD = 450mm(0.450m)$
--	----------------------

---

## Sensor Handling Instructions

This section reviews proper procedures for handling, cleaning, or storing the Linea GigE camera. Specifically the camera sensor needs to be kept clean and away from static discharge to maintain design performance.

### Electrostatic Discharge and the Sensor

Cameras sensors containing integrated electronics are susceptible to damage from electrostatic discharge (ESD).

Electrostatic charge introduced to the sensor window surface can induce charge buildup on the underside of the window that cannot be readily dissipated by the dry nitrogen gas in the sensor package cavity. With charge buildup, problems such as higher image lag or a highly non-uniform response may occur. The charge normally dissipates within 24 hours and the sensor returns to normal operation.



**Important:** Charge buildup will affect the camera's flat-field correction calibration. To avoid an erroneous calibration, ensure that you perform flat-field correction only after a charge buildup has dissipated over 24 hours.

### Protecting Against Dust, Oil and Scratches

The sensor window is part of the optical path and should be handled like other optical components, with extreme care.

Dust can obscure pixels, producing dark patches on the sensor response. Dust is most visible when the illumination is collimated. The dark patches shift position as the angle of illumination changes. Dust is normally not visible when the sensor is positioned at the exit port of an integrating sphere, where the illumination is diffuse.

Dust can normally be removed by blowing the window surface using a compressed air blower, unless the dust particles are being held by an electrostatic charge, in which case either an ionized air blower or wet cleaning is necessary.

Oil is usually introduced during handling. Touching the surface of the window barehanded will leave oily residues. Using rubber finger cots and rubber gloves can prevent oil contamination. However, the friction between the rubber and the window may produce electrostatic charge that may damage the sensor.

Scratches can be caused by improper handling, cleaning or storage of the camera. When handling or storing the camera without a lens, always install the protective cap. Scratches diffract incident illumination. When exposed to uniform illumination, a sensor with a scratched window will normally have brighter pixels adjacent to darker pixels. The location of these pixels changes with the angle of illumination.

## **Cleaning the Sensor Window**

Even with careful handling, the sensor window may need cleaning. The following steps describe various cleaning techniques to clean minor dust particles to accidental finger touches.

- Use compressed air to blow off loose particles. This step alone is usually sufficient to clean the sensor window. Avoid moving or shaking the compressed air container and use short bursts of air while moving the camera in the air stream. Agitating the container will cause condensation to form in the air stream. Long air bursts will chill the sensor window causing more condensation. Condensation, even when left to dry naturally, will deposit more particles on the sensor.
- When compressed air cannot clean the sensor, Dalsa recommends using lint-free ESD-safe cloth wipers that do not contain particles that can scratch the window. The Anticon Gold 9"x 9" wiper made by Milliken is both ESD safe and suitable for class 100 environments. Another ESD acceptable wiper is the TX4025 from Texwipe.
- An alternative to ESD-safe cloth wipers is Transplex swabs that have desirable ESD properties. There are several varieties available from Texwipe. Do not use regular cotton swabs, since these can introduce static charge to the window surface.
- Wipe the window carefully and slowly when using these products.

---

## Ruggedized RJ45 Ethernet Cables

Components Express Inc. has available an industrial RJ45 CAT6 cable that on one end has a molded shroud assembly with top/bottom thumbscrews, while the other end has a standard RJ45. This cable is recommended when Linea GigE is installed in a high vibration environment.

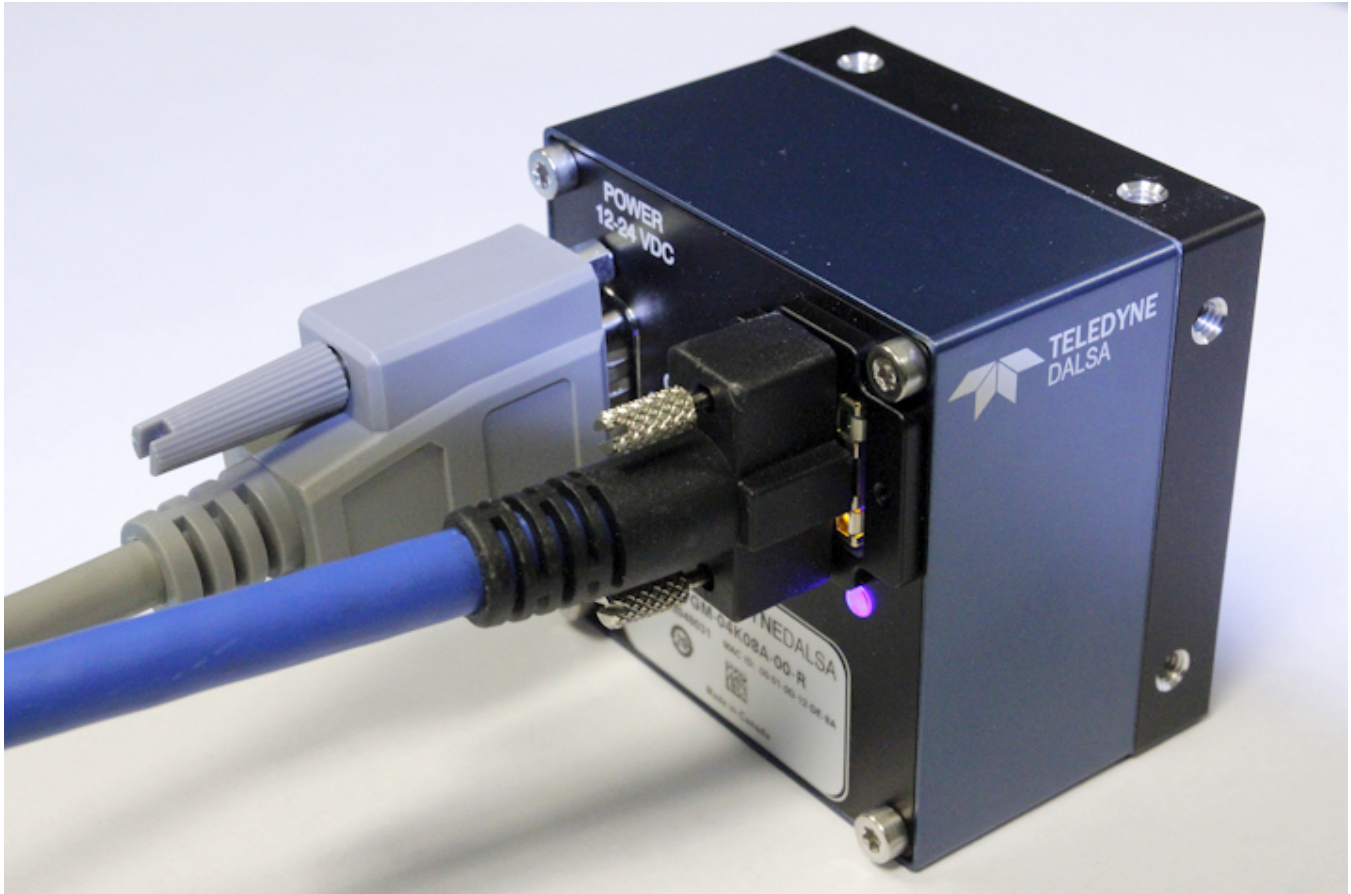

**All cables made in U.S.A. – all cables RoHS compliant.**

CAT6 certified (tested for near end / far end crosstalk and return loss).

IGE-3M (3meters)  
IGE-10M (10meters)  
IGE-25M (25meters)  
IGE-50M (50meters)  
IGE-100M (100meters)

**For Information contact:**



Components Express, Inc. (CEI)  
10330 Argonne Woods Drive, Suite 100  
Woodridge, IL 60517-4995  
Phone: 630-257-0605 / 800.578.6695 (outside Illinois)  
Fax: 630-257-0603  
<http://www.componentsexpress.com/>

# Troubleshooting

## Overview

In rare cases an installation may fail or there are problems in controlling and using the Linea GigE camera. This section highlights issues or conditions which may cause installation problems. Emphasis is on the user to perform diagnostics with the tools provided and methods are described to correct the problem.

The GigE Server status provides visual information on possible Linea GigE problems. The three states are shown in the following table. Descriptions of possible conditions causing an installation or operational problem follow. Note that even an installation with no networking issue may still require optimization to perform to specification.

	Device Not Available	Device IP Error	Device Available
<b>GigE Server Tray Icon:</b>			
Note: It will take a few seconds for the GigE Server to refresh its state after any change.	A red X will remain over the GigE server tray icon when the camera device is not found. This indicates a network issue where there is no communication with the camera.	The GigE server tray icon shows a warning when a device is connected but there is some type of IP error.	The GigE server tray icon when the device is found. The camera has obtained an IP address and there are no network issues. Optimization may still be required to maximize performance.

## Problem Type Summary

Linea GigE problems are either installation types where the camera is not found on the network or setup errors where the camera is found but not controllable. Additionally the Linea GigE may be properly installed but network optimization is required for maximum performance. The following links jump to various topics in this troubleshooting section.



### Device Not Available

A red X over the GigE server tray icon indicates that the camera device is not found. This indicates either a major camera fault or condition such as disconnected power, or a network issue where there is no communication.

- Review the section "Using " on page 21 to verify required installation steps.
- Refer to the Teledyne DALSA Network Imaging manual to review networking details.
- The Linea GigE camera cannot acquire a DHCP.
- In multiple NIC systems where the NIC for the Linea GigE is using LLA mode, ensure that no other NIC is in or switches to LLA mode. It is preferable that the Teledyne DALSA DHCP

server is enabled on the NIC used with the camera instead of using LLA mode, which prevents errors associated with multiple NIC ports.

- Verify that your NIC is running the latest driver available from the manufacturer.



### **Device IP Error**

The GigE server tray icon shows a warning with IP errors. Review the following topics on network IP problems to identify and correct the condition.

Please refer to the Teledyne DALSA Network Imaging Package manual for information on the Teledyne DALSA Network Configuration tool and network optimization for GigE Vision cameras and devices.

### **Multiple Camera Issues**

- When using multiple cameras with a computer with multiple NIC ports, confirm each Linea GigE has been assigned an IP address by checking the GigE server.
- To reduce network traffic in configured problem free systems, use the Network Configuration tool to stop camera discovery broadcasts. Refer to the Teledyne DALSA Network Imaging manual.
- When using multiple cameras connected to an VLAN Ethernet switch, confirm that all cameras are on the same subnet setup on that switch. See the Teledyne DALSA Network Imaging package manual for more information. .
- If a Linea GigE camera installed with other GigE Vision cameras cannot connect properly with the NIC or has acquisition timeout errors, there may be a conflict with the third party camera's filter driver. In some cases third party filter drivers modify the NIC properties such that the Teledyne DALSA Sopera Network Imaging Driver does not install. Verify such a case by uninstalling the third party driver and installing the Linea GigE package again.
- Verify that your NIC is running the latest driver available from the manufacturer.



### **Device Available but with Operational Issues**

A properly installed Linea GigE with no network issues may still not perform optimally. Operational issues concerning cabling, Ethernet switches, multiple cameras, and camera exposure are discussed in the following sections:

#### **Always Important**

- Why should Linea GigE firmware be updated? See "Firmware Updates" on page 134.
- "Power Failure During a Firmware Update—Now What?" on page 135.
- "Cabling and Communication Issues" on page 135.
- See "Preventing Operational Faults due to ESD" on page 20 to avoid random packet loss, random camera resets, and random loss of Ethernet connections.

#### **No Timeout messages**

- I can use CamExpert to grab (with no error message) but there is no image (display window stays black). See "Acquisition Error without Timeout Messages" on page 136.
- I can use CamExpert to grab (with no error message) but the frame rate is lower than expected. See "Camera acquisition is good but frame rate is lower than expected" on page 136.
- There is no image and the line rate is lower than expected. See "Camera is functional but frame rate is lower than expected" on page 136.

- There is no image but the frame rate is as expected.  
See "Camera is functional, line rate is as expected, but image is black" on page 136.

### **Other problems**

- Buffer Incomplete message. See Buffer Incomplete Error Message.

## **Verifying Network Parameters**

Teledyne DALSA provides the Network Configuration tool to verify and configure network devices and the Linea GigE network parameters. See section Network Configuration Tool of the Teledyne DALSA Network Imaging manual, if there were any problems with the automatic Linea GigE software installation.

### ***Before Contacting Technical Support***

Carefully review the issues described in this Troubleshooting section. To aid Teledyne DALSA personnel when support is required, the following should be included with the request for support.

- From the Start menu, go to **Programs • Dalsa • Sopera LT • Tools** and run the **Log Viewer** program. From its File menu click on **Save Messages** to generate a log text file.
- Report the version of GigE Vision software and Sopera version used.

---

## **Installation Issues and Functional Problems**

This section covers issues that are apparent after installation or are indicated by the GigE server tray icon showing a warning symbol.

---

## **Device Available with Operational Issues**

This section considers issues with cabling, Ethernet switches, multiple cameras, and camera exposure. All information concerning the Teledyne DALSA Network Configuration Tool and other networking considerations is available in the **Teledyne DALSA Network Imaging manual**.

### **Firmware Updates**

As a general rule any Linea GigE installation must include the firmware update procedure (see "File Access Control Category" on page 104). Linea GigE camera firmware that does not match a newer version of installed GigE Vision software is likely to have unpredictable behavior. Problems might be:

- Linea GigE is not found by the device discovery process.
- Linea GigE is found by the Sopera GigE Server but an application such as CamExpert does not see the camera.
- A Linea GigE that had a fault with a firmware update will automatically recover by booting with the previous firmware version.



**Important:** New cameras installed in previously deployed systems are fully backward compatible with the older vision application.



## Power Failure During a Firmware Update—Now What?

Don't panic! There is far greater chance that the host computer OS is damaged during a power failure than any permanent problems with the Linea GigE. When electrical power returns and the host computer system starts, follow this procedure:

- Connect power to the Linea GigE. The camera processor knows that the firmware update failed.
- The Linea GigE will boot with the previous version of firmware and will operate normally.
- Perform the firmware update procedure (see "File Access Control Category" on page 104) again.

## Cabling and Communication Issues

With only two cables connected to Linea GigE, possible cabling issues are limited.

### Power supply problems:

- If the Linea GigE status LED is off, the DC supply power is not connected or faulty. Verify the power supply voltage.

### Communication Problems:

- Use a shielded cable where the connector shell electrically connects the Linea GigE chassis to the power supply earth ground. This can eliminate trigger issues in a high EMI environment.
- Check that the Ethernet cable is clipped both to the camera and the NIC or switch on the other end.
- Verify the Ethernet cabling. Poor cables will cause connections to auto-configure at lower speeds.
- Use a secured Ethernet cable when the Linea GigE is in a high vibration environment. See "Ruggedized RJ45 Ethernet Cables" on page 131.
- Check the Ethernet status LEDs on the Linea GigE RJ45 connector. The Link Status indicator is on and the activity LED should flash with network messages.
- Verify that the Ethernet cable is CAT5e or CAT6. This is very important with long cable lengths.
- When using very long cables, up to the maximum specified length of 100m for gigabit Ethernet, different NIC hardware and EMI conditions can affect the quality of transmission.
- Minimum recommended Ethernet cable length is 3 feet (1 meter).
- Use the Log Viewer tool (see point below) to check on packet resend conditions.
- Run the Sopera Log Viewer: **Start • Programs • Teledyne DALSA • Sopera LT • Tools • Log Viewer**. Start the camera acquisition program, such as CamExpert. There should not be any "packet resend" messages, else this indicates a control or video transmission problem due to poor connections or extremely high EMI environments.

## Acquisition Error without Timeout Messages

Streaming video problems range from total loss of image data to occasional loss of random video data packets. The following section describes conditions identified by Teledyne DALSA engineering while working with GigE Vision cameras in various computers and setups. See the Teledyne DALSA Network Imaging manual for information on network optimizations.

### ***No camera exposure when expected***

- Verify by using the camera in free-running mode. Do not use external trigger mode when testing a camera setup.
- If using free-running mode, verify that the exposure period is set to the maximum possible for the set frame rate.
- Load factory default from the Power-up Configuration in CamExpert. This will reset the camera to its nominal acquisition rate.

### ***Camera is functional but frame rate is lower than expected***

- Verify Ethernet link speed. If the LAN connection is limited to 100 Mbps, the line rate maximum will be limited once the internal buffers are filled. See the Teledyne DALSA Network Imaging manual for information on network optimizations.
- If using an external trigger, verify the trigger source rate and camera parameters such as trigger to exposure delay.

### ***Camera acquisition is good but frame rate is lower than expected***

- While running CamExpert and grabbing in free-run mode at the maximum frame rate, start the **Sapera Monitor** tool from the Sapera Tools installed with Sapera.
- Make sure the **Memory Overflow** event monitor is enabled.
- Continue grabbing from the camera at maximum frame rate. If any memory overflow events are counted, then the internal buffer could not be transmitted on time and was discarded. Such a condition may occur with large frame color or high frame rate cameras.
- Note that the Sapera CamExpert tool has limits to the maximum frame rate possible due to CamExpert generating an interrupt for each acquired frame. The Sapera Grab Demo may be better suited for testing at higher frame rates.
- Verify that network parameters are optimal as described in the Teledyne DALSA Network Imaging Module manual. Ensure the host computer is not executing other network intensive tasks. Try a different Gigabit NIC.
- Note that a changed acquisition frame rate becomes active only when the acquisition is stopped and then restarted.

### ***Camera is functional, line rate is as expected, but image is black***

- Verify that the lens iris is open.
- Aim the Linea GigE at a bright light source.
- Check that the programmed exposure duration is not too short or set it to maximum. See "Sensor Control Category" on page 37.
- Using CamExpert set the Linea GigE to output its Internal Pattern Generator. This step is typically done for any camera installation to quickly verify the Linea GigE and its software package. See "Metadata Format" on page 83 for information on using CamExpert to select internal patterns.

## **Other Problems or Issues**

This section describes problems that do not fit any of the categories above. Typically these are issues found in the field under specific or unusual conditions.

### ***Buffer Incomplete Error Message***

This message is generated when the logical acquisition frame buffer takes longer to fill (line rate x frame buffer height) than the time set for the GigE Vision Host Control feature "**Image Timeout**". Simply increase the "Image Timeout" value as required.

### ***Issues with Cognex VisionPro***

When the Cognex VisionPro package is uninstalled, the Linea GigE becomes not available within CamExpert due to the Cognex uninstaller removing GigE Vision components. This forces the user to reinstall the camera package.

Cognex VisionPro remains a useable third party product except for their uninstaller fault. Users just need to account for this issue until resolved by Cognex.

# Contact Information

---

## Sales Information

<b>Visit our web site:</b>	<a href="http://www.teledynedalsa.com/mv">www.teledynedalsa.com/mv</a>
<b>Email:</b>	<a href="mailto:info@teledynedalsa.com">mailto:info@teledynedalsa.com</a>

Canadian Sales	
Teledyne DALSA — Head office 605 McMurray Road Waterloo, Ontario, Canada, N2V 2E9 Tel: 519 886 6000 Fax: 519 886 8023	Teledyne DALSA — Montreal office 880 Rue McCaffrey Saint-Laurent, Quebec, Canada, H4T 2C7 Tel: (514) 333-1301 Fax: (514) 333-1388
USA Sales	European Sales
Teledyne DALSA — Billerica office 700 Technology Park Drive Billerica, Ma. 01821 Tel: (978) 670-2000 Fax: (978) 670-2010 <a href="mailto:sales.americas@teledynedalsa.com">sales.americas@teledynedalsa.com</a>	Teledyne DALSA GMBH Lise-Meitner-Str. 7 82152 Krailling (Munich), Germany Tel: +49 – 89 89545730 Fax: +49 – 89 895457346 <a href="mailto:sales.europe@teledynedalsa.com">sales.europe@teledynedalsa.com</a>
Asian Sales	
Teledyne DALSA Asia Pacific Ikebukuro East 13F 3-4-3 Higashi Ikebukuro, Toshima-ku, Tokyo, Japan Tel: +81 3 5960 6353 Fax: +81 3 5960 6354 <a href="mailto:sales.asia@teledynedalsa.com">sales.asia@teledynedalsa.com</a>	Shanghai Industrial Investment Building Room G, 20F, 18 North Cao Xi Road, Shanghai, China 200030 Tel: +86-21-64279081 Fax: +86-21-64699430

---

## Technical Support

Submit any support question or request via our web site:

Technical support form via our web page: Support requests for imaging product installations, Support requests for imaging applications	<a href="http://www.teledynedalsa.com/mv/support">http://www.teledynedalsa.com/mv/support</a>
Camera support information	
Product literature and driver updates	