

*Operator's Manual*  
*Coherent StingRay Diode Laser Products*





*Operator's Manual*  
*Coherent StingRay Diode Laser Products*



27650 SW 95th Ave.  
Wilsonville, OR 97070

This document is copyrighted with all rights reserved. Under the copyright laws, this document may not be copied in whole or in part or reproduced in any other media without the express written permission of Coherent, Inc. Permitted copies must carry the same proprietary and copyright notices as were affixed to the original. This exception does not allow copies to be made for others, whether or not sold, but all the material purchased may be sold, given, or loaned to another person. Under the law, copying includes translation into another language.

Coherent and the Coherent Logo are trademarks or registered trademarks of Coherent, Inc. All other trademarks or registered trademarks are the property of their respective owners.

Patents referenced in this document were active as of the printing date of the manual (see last page for date). The patents referenced herein may have expired. You are advised to check to see if the patents are still active: <http://portal.uspto.gov/external/portal/pair>.

Every effort has been made to ensure that the data given in this document is accurate. The information, figures, tables, specifications and schematics contained herein are subject to change without notice. Coherent makes no warranty or representation, either expressed or implied with respect to this document. In no event will Coherent be liable for any direct, indirect, special, incidental or consequential damages resulting from any defects in its documentation.

## **Technical Support**

### **In the US:**

Should you experience any difficulties with your laser or need any technical information, please visit our website: [www.Coherent.com](http://www.Coherent.com). Additional support can be obtained by contacting our Technical Support Hotline at 1.800.367.7890 (1.408.764.4557 outside the U.S.), or e-mail [Product.Support@Coherent.com](mailto:Product.Support@Coherent.com). Telephone coverage is available around the clock (except U.S. holidays and company shutdowns).

If you call outside our office hours, your call will be taken by our answering system and will be returned when the office reopens.

If there are technical difficulties with your laser that cannot be resolved by support mechanisms outlined above, e-mail, or telephone Coherent Technical Support with a description of the problem and the corrective steps attempted. When communicating with our Technical Support Department via the web or telephone, the Support Engineer responding to your request will require the model and Laser Head serial number of your laser system.

### **Outside the US:**

If you are located outside the U.S., visit our website for technical assistance or contact our local service representative. Representative phone numbers and addresses can be found on the Coherent website: [www.Coherent.com](http://www.Coherent.com).

Coherent provides telephone and web technical assistance as a service to its customers and assumes no liability thereby for any injury or damage that may occur contemporaneous with such services. These support services do not affect, under any circumstances, the terms of any warranty agreement between Coherent and the buyer. Operation of any Coherent laser with any of its interlocks defeated is always at the operator's own risk

# TABLE OF CONTENTS

Preface .....	vi
Export Control Laws Compliance .....	vi
Signal Words and Symbols in this Manual .....	vii
Signal Words .....	vii
Symbols .....	viii
Incoming Inspection .....	ix
Installing the Coherent Connection Software .....	ix
<b>Section One: Laser Safety .....</b>	<b>1-1</b>
Protecting Devices .....	1-1
Cap .....	1-2
Laser Controller with Safety Interlock for Class IIIb Lasers.....	1-2
Laser Safety and Classification.....	1-3
Classification .....	1-3
CDRH Classification .....	1-6
IEC Classification .....	1-6
Classification Requirements .....	1-7
CDRH Requirements .....	1-7
IEC Requirements.....	1-8
Declaration of Conformity.....	1-8
<b>Section Two: Laser Operation .....</b>	<b>2-1</b>
Power Requirements .....	2-2
115 or 220 VAC Operation .....	2-2
Turning the Laser ON .....	2-2
Turning the Laser OFF.....	2-4
Lasers with a Controller.....	2-4
Modulating the Laser .....	2-4
Operating Environment.....	2-6
Installing a Mounting Bracket .....	2-7
Coherent StingRay and RS-232 .....	2-8
<b>Section Three: Servicing Your Coherent StingRay Laser .....</b>	<b>3-1</b>
Focusing Lasers .....	3-2
Focusing Coherent StingRay Lasers.....	3-2
Cleaning the Optics.....	3-2
Cleaning Diffraction Gratings.....	3-3
Operating Hints.....	3-3
<b>Section Four: Laser Controller .....</b>	<b>4-1</b>
Front Panel.....	4-2
Keypad .....	4-2
Status LED Indicators .....	4-3
Interlock Jumper .....	4-3

Back Panel .....	4-4
Laser Head Connector .....	4-4
Power In Connector .....	4-4
BNC Connector.....	4-4
USB Connector .....	4-5
Specifications.....	4-5
<b>Section Five: Host Interface.....</b>	<b>5-1</b>
Host Command Quick Reference .....	5-1
Message Considerations .....	5-2
Communication Port Selection .....	5-2
Message Completion Handshake.....	5-3
Message Terminators .....	5-4
Messages Received by the Laser .....	5-4
Messages Sent by the Laser .....	5-4
Message Syntax .....	5-4
Command Prompt.....	5-5
Commands and Queries .....	5-5
SCPI Error Codes.....	5-10
<b>Section Six: Product Repair.....</b>	<b>6-1</b>
Product Shipping Instructions.....	6-1
<b>Appendix A: Warranty .....</b>	<b>A-1</b>
<b>Glossary .....</b>	<b>Glossary-1</b>
<b>Index .....</b>	<b>Index-1</b>

## LIST OF FIGURES

1-1. Laser Controller with Safety Interlock .....	1-2
1-2. Setup for CDRH and IEC Classification .....	1-4
2-3. Modulation Curves .....	2-5
2-4. Standard Coherent StingRay with Mounting Bracket.....	2-7
3-5. Coherent StingRay Focus Ring and Focus Lock .....	3-2
4-6. Coherent StingRay Controller Front Panel .....	4-2
4-7. Coherent StingRay Controller Back Panel .....	4-4

# LIST OF TABLES

1-1.	Possible CDRH and IEC Classifications for Coherent StingRay Lasers.....	1-4
2-2.	Pin Out Table .....	2-2
2-3.	LED Indicator and Analog Output Status.....	2-3
2-4.	Modulation Characteristics and States.....	2-6
2-5.	RS-232 Pinouts and Wiring .....	2-8
4-6.	Coherent StingRay Controller Status LED States.....	4-3
4-7.	Coherent StingRay Controller Specifications.....	4-5
5-1.	Host Command Quick Reference .....	5-1
5-2.	Fault Bit Codes .....	5-6
5-3.	Status Code Bit Definitions .....	5-8
5-4.	SCPI Error Codes.....	5-10

## **Preface**

This manual contains user information for Coherent StingRay Diode Laser. Your Coherent StingRay structured light-generating laser features high quality glass optics that provides uniform intensity distribution laser light and a rugged housing to maximize the reliability of the laser. For insured longer lifetime, each diode laser has undergone a burn-in period and a final quality control check before shipment.

## **Export Control Laws Compliance**

It is the policy of Coherent to comply strictly with U.S. export control laws.

Export and re-export of lasers manufactured by Coherent are subject to U.S. Export Administration Regulations, which are administered by the Commerce Department. In addition, shipments of certain components are regulated by the State Department under the International Traffic in Arms Regulations.

The applicable restrictions vary depending on the specific product involved and its destination. In some cases, U.S. law requires that U.S. Government approval be obtained prior to resale, export or re-export of certain articles. When there is uncertainty about the obligations imposed by U.S. law, clarification must be obtained from Coherent or an appropriate U.S. Government agency.

Products manufactured in the European Union, Singapore, Malaysia, Thailand: These commodities, technology, or software are subject to local export regulations and local laws. Diversion contrary to local law is prohibited. The use, sale, re-export, or re-transfer directly or indirectly in any prohibited activities are strictly prohibited.



## Signal Words and Symbols in this Manual

This documentation may contain sections in which particular hazards are defined or special attention is drawn to particular conditions. These sections are indicated with signal words in accordance with ANSI Z-535.6 and safety symbols (pictorial hazard alerts) in accordance with ANSI Z-535.3 and ISO 7010.

### Signal Words

Four signal words are used in this documentation: **DANGER**, **WARNING**, **CAUTION** and **NOTICE**.

The signal words **DANGER**, **WARNING** and **CAUTION** designate the degree or level of hazard when there is the risk of injury:

---

#### **DANGER!**

Indicates a hazardous situation that, if not avoided, will result in death or serious injury. This signal word is to be limited to the most extreme situations.

---

---

#### **WARNING!**

Indicates a hazardous situation that, if not avoided, could result in death or serious injury.

---

---

#### **CAUTION!**

Indicates a hazardous situation that, if not avoided, could result in minor or moderate injury.

---

The signal word “**NOTICE**” is used when there is the risk of property damage:

---

#### **NOTICE!**

Indicates information considered important, but not hazard-related.

---

Messages relating to hazards that could result in both personal injury and property damage are considered safety messages and not property damage messages.

## Symbols

The signal words **DANGER**, **WARNING**, and **CAUTION** are always emphasized with a safety symbol that indicates a special hazard, regardless of the hazard level:



---

**This symbol is intended to alert the operator to the presence of important operating and maintenance instructions.**

---



---

**This symbol is intended to alert the operator to the danger of exposure to hazardous visible and invisible laser radiation.**

---



---

**This symbol is intended to alert the operator to the presence of dangerous voltages within the product enclosure that may be of sufficient magnitude to constitute a risk of electric shock.**

---



---

**This symbol is intended to alert the operator to the danger of Electro-Static Discharge (ESD) susceptibility.**

---



---

**This symbol is intended to alert the operator to the danger of crushing injury.**

---



---

**This symbol is intended to alert the operator to the danger of a lifting hazard.**

---

## Incoming Inspection

Immediately upon receipt of your product, examine the packaging material and contents for shipment damage. Report any such instance to your receiving department or shipping company.

Your shipment should contain the items shown below.

<p>(1) Coherent StingRay laser</p> 	<p>(1) USB flash drive and (1) Allen key</p> 
<p>(1) <i>Laser Safety and Installation Quick Start Guide</i> (1223125)</p> 	<p>(1) Final QC report</p> 

## Installing the Coherent Connection Software



To install the software (P/N 1255080):

1. Close all programs.
2. Insert the Coherent StingRay flash drive into a USB port on your computer.
3. Double-click the *Coherent\_Connection\_Setup.exe* file to start the installation process.

4. Follow the on-screen instructions.

---

**The Coherent Connection software is an optional interface that, if enabled, can be used to communicate with the RS-232 feature of the laser. This software is not required to interface and communicate with the laser—any serial communication interface can be used. See “Section Five: Host Interface” (p. 5-1) for protocol and commands**

---

# SECTION ONE: LASER SAFETY

In this section:

- Protecting devices (this page)
- Laser safety and classification (p. 1-3)
- Declaration of conformity (p. 1-8)



---

## **DANGER!**

**The laser light emitted by this laser may be in the infrared area of the electromagnetic spectrum and may not be visible to the human eye. Use extreme caution at all times when using the laser.**

---



---

## **DANGER!**

**The output power of this laser is high enough to cause permanent damage to the human eye. Wear appropriate laser safety goggles at all times when the laser is operational.**

---

## **Protecting Devices**



---

## **WARNING!**

**Use of controls, adjustments, or performance of procedures other than those specified herein may result in hazardous radiation exposure and will void the product warranty.**

---

There are two types of protecting devices for your laser:

- Cap
- Laser controller with remote interlock (optional)

These are discussed, next.

## Cap

The cap serves to protect the laser during storage or inactivity. To use the cap, slide it onto the laser face. Do not use the cap to block laser light because the heated material could contaminate the optical components.

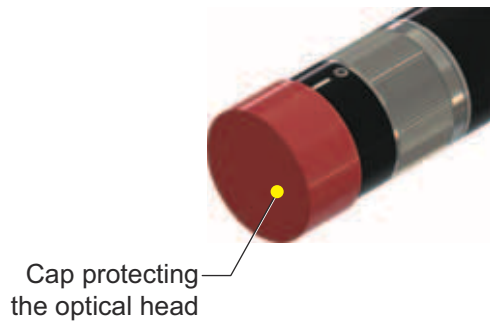

## Laser Controller with Safety Interlock for Class IIIb Lasers

To be used as standalone units, Class IIIb lasers require the installation of a safety mechanism that prevents exposure to the laser light. As such, if you intend to bring your laser into Class IIIb compliance, you may wish to purchase a laser controller with safety interlock (P/N 1225414).

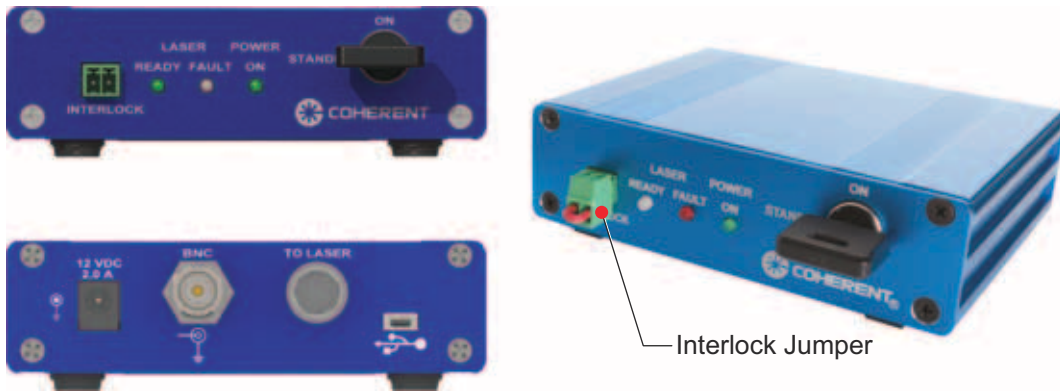

**Figure 1-1. Laser Controller with Safety Interlock**

The controller has an interlock circuit that must be closed for the laser to operate—it must have the interlock jumper plugged into it and the key switched to ON. This means that you can use the Interlock connector two ways:

1. *(for general use)* Plug the shorted jack into the safety interlock and switch ON the key for normal laser operation. After a short delay, light is emitted from the laser. The laser automatically shuts off if the shorted jack is not in place.
2. *(for the interlock system)* When the interlock circuit is opened, the laser automatically shuts off. This can be used as a safety feature. For example, you can connect the two wires of the 1/8" interlock plug to a door contact switch (remove the cover and solder from the interlock connector, then re-solder the twin leads to the appropriate pins and replace the cover). Opening the door will open the Interlock circuit and the laser will turn off automatically.

The laser controller is a multi-functional interface which provide feedback, status, and control of the laser, in addition to the safety features, to comply with end-use applications. The controller also provides interface to the laser for remote connection of power, modulation, and communication. Features include:

1. Power to the Laser
2. Modulation to the laser via the BNC connector
3. USB interface to the laser for communication and parameter setting
4. Visible indication of the laser status

For information on how to install a laser controller into your Coherent StingRay laser system, refer to the *Coherent StingRay Laser Safety and Installation Quick Start Guide* (1223125) that shipped with your product.

## **Laser Safety and Classification**

### **Classification**

Lasers are classified based upon the output power and the wavelength of a laser beam in a particular setup according to the United States Center for Devices & Radiological Health (CDRH) document 21 CFR 1040.10 and upon demand, to the International Electrotechnical Commission (IEC) document 60825-1:2<sup>nd</sup> edition, 2007-03. The protocol for classification described herein is a general outline of the procedures. In actual practice, the settings can differ depending on the laser. Call us for details.

The laser beam (either as a raw or modified beam) is aimed into a 7 mm aperture located some distance away from the laser. The sensor placed just behind the aperture records the highest output power level of the laser beam—see Table 1-1 (p. 1-4) for details. In the case of a line laser, the entire line is scanned to find the highest output power.

With conventional Gaussian line generators, it is generally the hot central spot that causes its safety rating to go up one class (from CDRH Class II to IIIa, for example). Our optics produce a line of uniform intensity that does not have a hot spot at the center. Therefore, a Coherent StingRay non-Gaussian laser offers a safer level of exposure, in addition to more light and uniform illumination transmitted to your part.

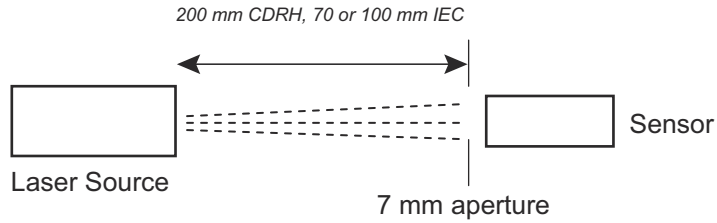

Figure 1-2. Setup for CDRH and IEC Classification

Table 1-1. Possible CDRH and IEC Classifications for Coherent StingRay Lasers

Organization	Class	Wavelength	Maximum Power <sup>a</sup> Some Distance Away From the Laser Source	Distance For Measuring Power <sup>b</sup>
CDRH	II	400 to 710 nm	1 mW	200 mm
	IIIa	400 to 710 nm	5 mW	200 mm
	IIIb	400 to 710 nm	500 mW	200 mm
		or > 710 nm	500 mW	200 mm
IEC	1	500 to 700 nm	0.39 mW	70 mm
	1M	500 to 700 nm	0.39 mW	100 mm
	2	400 to 700 nm	1 mW	70 mm
	2M	400 to 700 nm	1 mW	100 mm
	3R	400 to 700 nm	5 mW	70 mm
	3B	400 to 700 nm	500 mW	70 mm

a. For the IEC, wavelengths outside of those stated have different maximum power values.

b. CDRH—between laser aperture and sensor; IEC—between apparent focal point and sensor.

Generally speaking, the higher the safety class your laser is given, the higher becomes the risk of eye injury. **As a precaution, it is always advisable to wear appropriate safety goggles to protect your eyes from harmful radiation and, even for “eye-safe” classes, the laser beam should never be intentionally aimed at people.**

### CDRH Class II and IEC Class 1 and Class 2

Considered eye-safe, including while using optical instruments for intrabeam viewing. Normal exposure to this type of beam will not cause permanent damage to the retina, since the blinking reflex of the human eye is fast enough to avoid any damage. This safety rating is considered eye-safe, but can be hazardous if there is direct long-term ocular exposure. Lasers with this rating can be installed on the shop floor with a minimum of concerns.



### **CDRH Class IIIa and IEC Class 1M, Class 2M, and Class 3R**

Considered eye-safe with caution, but may present an eye hazard if viewed using collecting optics (magnifiers, binoculars, etc.). Focusing of this light into the eye could cause eye damage.

### **CDRH Class IIIb and IEC Class 3B**

Considered dangerous to your retina if exposed, including exposure when looking directly into a reflection from a specular (mirror-like) surface. Normally, lasers from this class will not produce a hazardous diffuse reflection. At higher levels of the class, these lasers can be skin hazards. It is important to follow laser safety rules and **wear appropriate protective eyewear** when working around these lasers.

The following directives are taken from section 12.5.2 of IEC 60825-1, 2001-08, and are good safety measures for both CDRH Class IIIb and IEC Class 3B lasers:

Class 3B lasers are potentially hazardous if a direct beam or specular reflection is viewed by the unprotected eye (intrabeam viewing). The following precautions should be taken to avoid direct beam viewing and to control specular reflections:

1. The laser should only be operated in a controlled area.
2. Care should be exercised to prevent unintentional specular reflections.
3. The laser beam should be terminated where possible at the end of its useful path by a material that is diffuse and of such a color and reflectivity as to make beam positioning possible while still minimizing the reflection hazards.



---

#### **CAUTION!**

**Conditions for safe viewing of diffuse reflections for Class 3B visible lasers are: minimum viewing distance of 13 cm between screen and cornea and a maximum viewing time of 10 sec. Other viewing conditions require a comparison of the diffuse reflection exposure with the MPE (maximum permissible exposure limit).**

---

4. **Eye protection is required** if there is any possibility of viewing either the direct or specularly reflected beam, or of viewing a diffuse reflection not complying with the conditions of item 3, above.
5. The entrance to areas should be posted with a standard laser warning sign.

## CDRH Classification

Our lasers can comply with CDRH classification and fall in different safety classes, depending on output power, wavelength, and fan angle.

### CDRH Class II, IIIa, and IIIb Warning/ID/Aperture Label Examples

Statement indicating that laser radiation is emitted from the aperture. Warning statement follows.

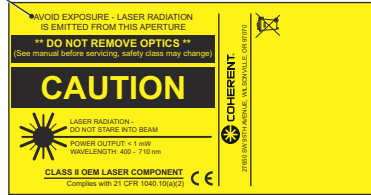

Trademark, company address, and serial number are printed on the right side of the label.

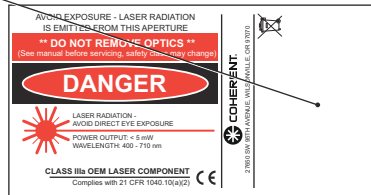

Power output and wavelength details are located here.

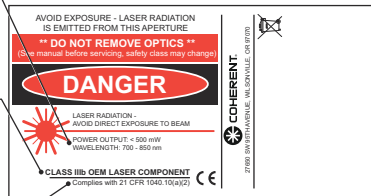

CDRH laser classification appears here.

Statement confirming laser CDRH compliance is printed on the bottom of the label.

## IEC Classification

Our lasers can comply with IEC classification (if it is required, make sure to mention it when ordering) and fall in different safety classes, depending on output power, wavelength, and fan angle.

### IEC Warning/ID/Aperture Label Examples



## **Classification Requirements**

Classification is obtained once the laser meets the criteria established by the CDRH or the IEC. Lasers are always classified in a safety class (CDRH Class II, IIIa, IIIb, and IEC Class 1, 1M, 2, 2M, 3R, 3B).

---

**Lasers do not need to be fully compliant unless the end-user requires it to be so. If required, make sure to mention it when ordering.**

---

## **CDRH Requirements**

### **Class II and IIIa**

1. Laser radiation emission indicator (LED lights up when laser is powered)
2. Permanently attached beam attenuator (a shutter)
3. Warning/ID/aperture label—see “CDRH Classification” (p. 1-6) and “IEC Classification” (p. 1-6)
4. Instruction manual

### **Class IIIb**

1. All items mentioned for Class II and IIIa lasers
2. Removable, key-actuated master control preventing lasing when removed
3. Remote interlock connector that prevents lasing when removed
4. Laser radiation emission indicator that turns on prior to lasing (LED that lights up 5 to 10 seconds before the laser lights up)
5. I/O switch

A laser controller can be ordered to fulfill criteria 2, 3, and 4. For more information, refer to “Laser Controller with Safety Interlock for Class IIIb Lasers” (p. 1-2).

**IEC Requirements**

**Class 1, 1M, 2, and 2M**

1. Warning/ID/aperture label affixed (sticker on the laser with all the required information – see above)
2. Instruction manual

**Class 3R**

1. All items mentioned for Class 1, 1M, 2, and 2M lasers
2. Laser radiation emission indicator (LED turning on when laser is powered) for lasers > 700 nm
3. A permanently attached beam attenuator (a shutter or switch)

**Class 3B**

1. All items mentioned for Class 3R lasers
2. Laser radiation emission indicator, regardless of wavelength
3. Removable, key-actuated master control that prevents lasing when removed
4. Remote interlock connector that prevents lasing above Class 1M or 2M when removed
5. Manual reset mechanism for Class 4

A laser controller can be ordered to fulfill criteria 3 and 4. For more information, refer to “Laser Controller with Safety Interlock for Class IIIb Lasers” (p. 1-2).

**Declaration of  
Conformity**

Declaration of Conformity certificates are available upon request.

## SECTION TWO: LASER OPERATION

In this section:

- Power requirements (p. 2-2)
- Turning the laser ON (p. 2-2)
- Turning the laser OFF (p. 2-4)
- Lasers with a controller (p. 2-4)
- Modulating the laser (p. 2-4)
- Operating environment (p. 2-6)
- Installing a mounting bracket (p. 2-7)
- Coherent StingRay and RS-232 (p. 2-8)



---

### **DANGER!**

**The laser light emitted by this laser may be in the infrared area of the electromagnetic spectrum. The laser light may not be visible to the human eye. Use extreme caution at all times when laser is in use.**

---



---

### **DANGER!**

**The output power of these laser is sometimes high enough to cause permanent damage to the human eye. Wear appropriate laser safety goggles at all times when the laser is operational.**

---

---

### **NOTICE!**

**Any reference in this manual to the “ON” and “OFF” positions of the main switch or safety interlock refers to the corresponding I/O button in the “I” (ON) and “O” (OFF) positions, respectively.**

---

## Power Requirements

The Coherent StingRay laser utilizes an auto scaling input power feature. The user can apply from 5 to 24 VDC to the system and the laser will regulate this input voltage to the operating requirement.

**Table 2-2. Pin Out Table**

Pin	Assignment	Wire Color
1	V <sub>in</sub> Gnd	Black
2	V <sub>mod</sub>	Blue
3	V <sub>mod</sub> Gnd	Red/Black
4	RS <sub>232</sub> Recv	White <sup>a</sup>
5	RS <sub>232</sub> Gnd	White/Black <sup>b</sup>
6	RS <sub>232</sub> Trans	Orange <sup>c</sup>
9	V <sub>in</sub>	Red
10	Fault	Green

- a. White = RS-232 receive from computer (serial connector, pin 3)
- b. White/Black = RS-232 ground (serial connector, pin 5)
- c. Orange = RS-232 transmit to computer (serial connector, pin 2)

## 115 or 220 VAC Operation

If your laser was ordered with a laser controller, it must be activated for the laser to function. Refer to “Laser Controller with Safety Interlock for Class IIIb Lasers” (p. 1-2) for details.

Coherent offers an optional power supply (P/N 1232091) for flying lead configurations.

## Turning the Laser ON



---

### **DANGER!**

**Do not point the laser towards an eye. You should wear appropriate laser safety goggles at all times when the laser is operational.**

---



**WARNING!**  
Use extreme caution at all times when laser is in use.



**WARNING!**  
Do not place any flammable objects directly in front of the free, non-extended beam (without the line generating optics), especially with higher power beams.

Once the laser is properly connected to the power supply, turn the power supply ON to operate the laser. The green LED at the back of the laser will light up—refer to Table 2-3 (p. 2-3).

**Table 2-3. LED Indicator and Analog Output Status**

	Red	Green	Analog Fault Output	Comment
Fault Condition	5 Hz flashing		5 Hz toggling	Reset by cycling power
Health Monitor	0.5 Hz flashing		0.5 Hz toggling	Reset automatically
All other conditions		Steady on	Low	

Pin 1

Pin 10

Multi-State LED

Fault Output (black & green)

For information on the controller Status LEDs, refer to Table 4-6 (p. 4-3).

## Turning the Laser OFF

To turn the laser off:

- Disconnect the power supply from its source.
- Disconnect the power supply from the laser.

## Lasers with a Controller

The input voltage for a controller is 12 VDC. For more information, refer to “Laser Controller with Safety Interlock for Class IIIb Lasers” (p. 1-2).

## Modulating the Laser

The standard laser runs in Continuous Wave mode; however, lasers can have two power adjustment options. These options must be chosen at the time of order.

1. **Pulsing and Power Adjustment:** Laser power can be modulated or pulsed by using an external signal. Lasers equipped with this option can be controlled by connecting the following-lines to the modulation source. (other connectors or wires are only available upon demand)
2. **Modulation Connection:**  $V_{Mod}$  Blue wire,  $V_{Mod}$  Gnd Red/Black wire.

To pulse and/or to modulate the laser power:

1. Mount the laser as desired and follow the procedure for aligning and focusing—refer to “Focusing Lasers” (p. 3-2).
2. Provide the laser with power—refer to “Turning the Laser ON” (p. 2-2).
3. Supply an appropriate voltage (variable power supply, computer, manual potentiometer, pulse generator, etc.) to the appropriate signal lines. As you vary the voltage being applied to the connector, the output power of the laser will also vary according to one of the modulation curves shown in Figure 2-3 (p. 2-5).



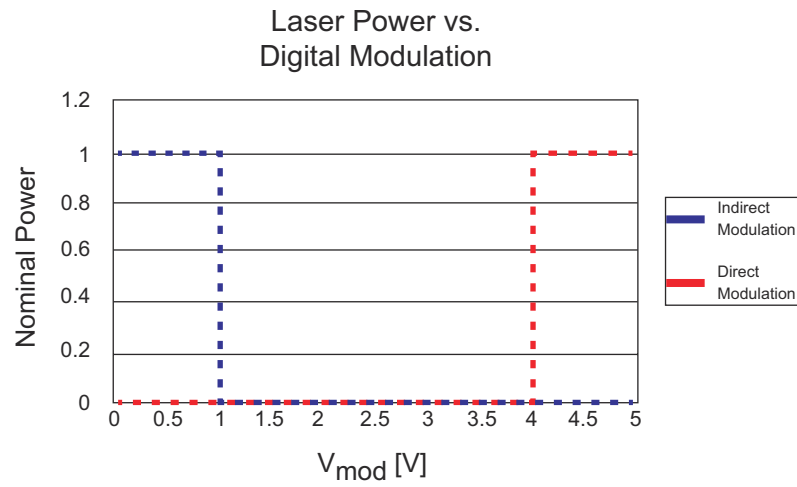
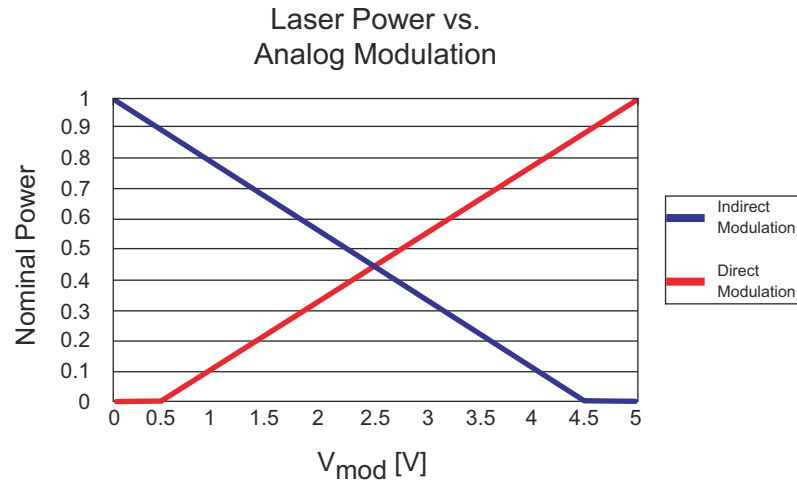

**Figure 2-3. Modulation Curves**

Table 2-4 (p. 2-6) describes the modulation characteristics and states for given applied voltages.

**Table 2-4. Modulation Characteristics and States**

Modulation	F <sub>max</sub>	Direct	Indirect
Analog	500 KHz	0 to 0.5 VDC	4.5 to 5 VDC
		<b>OFF</b>	
		0.5 to 5 VDC	0 to 4.5 VDC
		<b>LINEAR REGION</b>	
TTL	100 KHz	0 to 1 VDC	4 to 5 VDC
		<b>OFF</b>	
		4 to 5 VDC	0 to 1 VDC
		<b>ON</b>	
		1 to 4 VDC	1 to 4 VDC
<b>UNDEFINED</b>			
Fast TTL	2 MHz	0 to 1 VDC	4 to 5 VDC
		<b>OFF</b>	
		4 to 5 VDC	0 to 1 VDC
		<b>ON</b>	
		1 to 4 VDC	1 to 4 VDC
<b>UNDEFINED</b>			

## Operating Environment

Coherent StingRay lasers are suitable for regular indoor and outdoor use and function normally when the following environmental conditions are met:

- Altitudes up to 2000 m.
- Environments where the maximum relative humidity (RH) is 80% (for temperatures up to 31°C). Note that above 31°C, the RH decreases linearly from 80 to 50% (at 50°C).
- Environments in which the diode is soaked -10 to 50°C. In warmer environments, a heatsink or a thermoelectric cooler should be used to minimize the heat build-up. In extremely cold environments, care should be taken to maintain the laser above -10°C at all times.

---

### **NOTICE!**

**As with all semiconductor materials, avoid prolonged or repeated exposure to electrostatic charges or water droplets. All Coherent StingRay lasers are designed with ESD protection.**

---

Operate the laser in an environment in which there is normal aeration.

## Installing a Mounting Bracket

It is important to use a mounting bracket that is specifically designed to handle the heat dissipation requirements of our lasers, especially for those operating above 20 mW. Coherent StingRay lasers contain a built-in temperature monitoring circuit. Should the laser become too hot, the unit is designed to temporarily shut down. Full laser operation will only resume once the laser returns to normal operating temperatures and power is cycled.

If you would like to have a mounting bracket (P/N 1222896) shipped with your laser, make sure to mention it at the time you place the order. The standard mounting bracket has 4 thru-holes or M3 metric-threaded holes from the bottom for easy mounting. Once attached to the assembly, slide the laser (front end first) into the mount. Position the laser so there is full accessibility to the focusing element. Tighten the clamp on the laser mount.

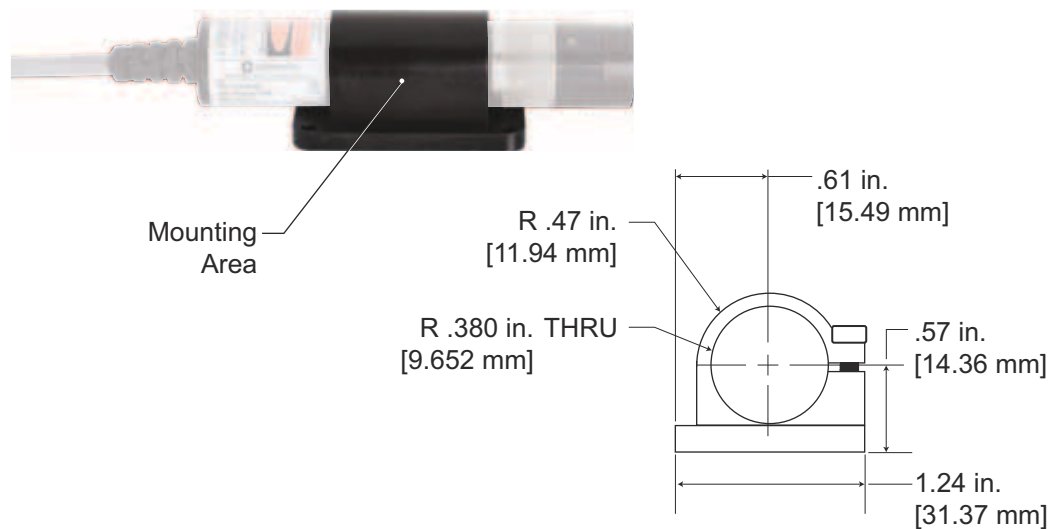

*Figure 2-4. Standard Coherent StingRay with Mounting Bracket*



---

### **NOTICE!**

**Always ensure that any support on which the laser is mounted is not made of insulating material, and that the heat of the laser can be properly transferred.**

---

# Coherent StingRay and RS-232

RS-232 can be connected directly to the laser via a flying lead or Hirose connector. For a list of RS-232 commands, refer to “Section Five: Host Interface” (p. 5-1). For a complete list of pin outs, refer to Table 2-2 (p. 2-2).

**Table 2-5. RS-232 Pinouts and Wiring**

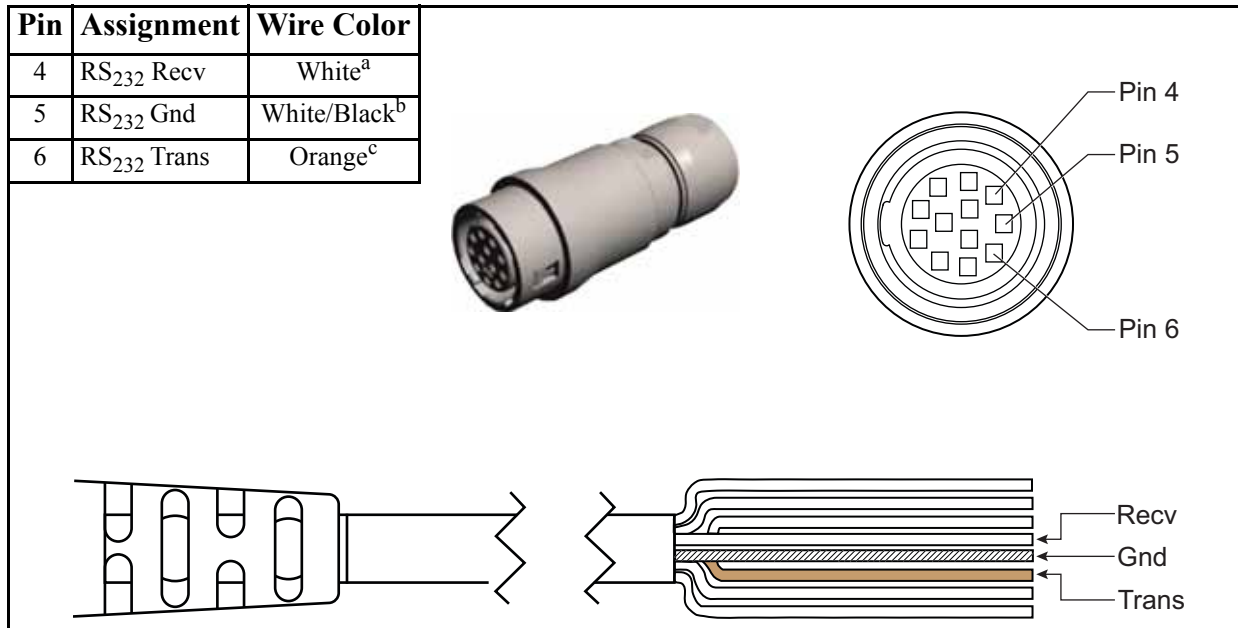

- a. White = RS-232 receive from computer (serial connector, pin 3)
- b. White/Black = RS-232 ground (serial connector, pin 5)
- c. Orange = RS-232 transmit to computer (serial connector, pin 2)

## SECTION THREE: SERVICING YOUR COHERENT STINGRAY LASER

In this section:

- Focusing lasers (p. 3-2)
- Cleaning the optics (p. 3-2)
- Operating hints (p. 3-3)



---

### **WARNING!**

Due to our optical design, most of our visible laser products are classified as CDRH Class II and IIIa products. These structured light devices meet this classification only as complete assemblies. Removal of the optical head (image generating optics) for cleaning could expose personnel to hazardous laser radiation (sometimes equivalent to a Class IIIb/3B laser) and will void the product safety classification. Turn the laser off whenever the optical head is removed unless alignment is being performed. Use extreme caution when performing these servicing operations and wear appropriate eyewear at all times. Servicing operations have to be performed by personnel trained to manipulate Class IIIb/3B lasers. Never look directly at a raw laser beam. Coherent will not be held liable for any injuries caused by product misuse.

---



---

### **WARNING!**

Use caution around all laser products. Lasers are highly concentrated light sources, some invisible to the eye. Never point a laser beam into your eyes or the eyes of another person—permanent damage to the retina can occur!

---



---

### **WARNING!**

Use of controls, adjustments, or performance of procedures other than those specified herein may result in hazardous radiation exposure and will void the product warranty.

---

Each Coherent StingRay laser is a self-contained unit and, as such, the only required service and maintenance procedures are explained in detail later in this section.

## Focusing Lasers

All lasers have been designed so that the focusing lens cannot be removed. If you have a specific application that requires accurate focusing and you would like your laser to be pre-focused using a beam profiler, contact your sales representative or Coherent.

### Focusing Coherent StingRay Lasers

Coherent StingRay is equipped with a state of the art translation focus mechanism. To focus the laser:

1. Using the 0.035 hex Allen wrench (provided), loosen the focus lock.
2. Grasp the focus ring and rotate the focus until it reaches the desired minimum thickness at the working distance you are using the laser.
3. Tighten the focus lock.



Figure 3-5. Coherent StingRay Focus Ring and Focus Lock

## Cleaning the Optics

If the laser pattern becomes fuzzy or unclear:

- Confirm that the image is focused. If it is not focused, follow the instructions under the “Focusing Coherent StingRay Lasers” heading, above.

- Verify that the optics are not contaminated. If the optics are contaminated, it is best to try and remove visible contamination by blowing dry air across the surface. Make sure the air product is oil- and moisture-free. If this technique fails to remove the contaminants, gently wipe the glass surface with a piece of slightly damp lens tissue.

## Cleaning Diffraction Gratings

All lasers projecting a pattern other than a dot, a single line, or a crosshair, have a diffraction grating. If your laser has a diffraction grating, only use a sterile jet of nitrogen or air to clean the surface of the grating. Using other products will cause damage.

## Operating Hints

A broad line or band of light can be projected (*line-generating lasers only*) by slightly de-focusing the laser source. Follow the instructions under “Focusing Lasers” (p. 3-2), but try to enlarge the image spot at your desired target distance. A larger dot area at the focus distance creates a dimmer pattern. Try to determine the best focused spot size for your band of light application.

The angle of illumination and detection can greatly enhance a characteristic or defect you may be trying to capture. If physical parameters allow, optimize the camera or sensor position relative to the laser position. See the examples in the following figure.

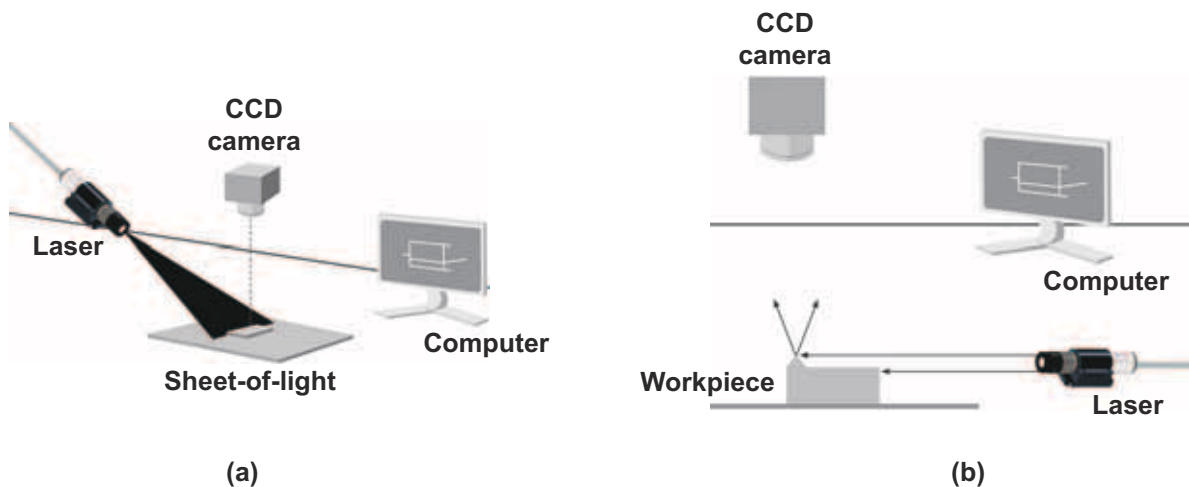

(a) A laser at a steep angle can be useful for edge, trim, and insertion detection.

(b) A laser mounted at a low angle tends to highlight surface topography and edge characteristics. This has proven to be useful in such applications as semiconductor orientation systems or magazine and newspaper counting systems. As the material moves by, the lines are bent by the edges and a vision system counts the bent line shapes.



## SECTION FOUR: LASER CONTROLLER

In this section:

- Front panel (p. 4-2)
- Back panel (p. 4-4)
- Specifications (p. 4-5)

The Coherent StingRay Controller is a small control box that allows you to connect to—and interface with—a single laser head. Coherent StingRay Controllers are “stackable,” which permits multiple controllers to be set up in a single system.



---

***NOTICE!***

**To be CDRH compliant, you must use a Coherent StingRay Controller with the laser head—the laser head alone is not CDRH compliant.**

---

The Coherent StingRay Controller offers an ON/STANDBY keyswitch, a remote interlock, and an emission indicator. With these safety features, the system is CDRH compliant.



---

***NOTICE!***

**In RS-232-enabled units, the CDHR Delay flag can be turned on or off. If the flag is ON, the laser will begin emitting 3 seconds after power is applied. In units that do not have this feature, the default is OFF.**

---

The modulation BNC connector is used for analog or digital modulation or variable power control. Review Analog Modulation specifications for input requirements.

## Front Panel

Indicators and connectors on the Coherent StingRay Controller front panel are shown in the following figure.

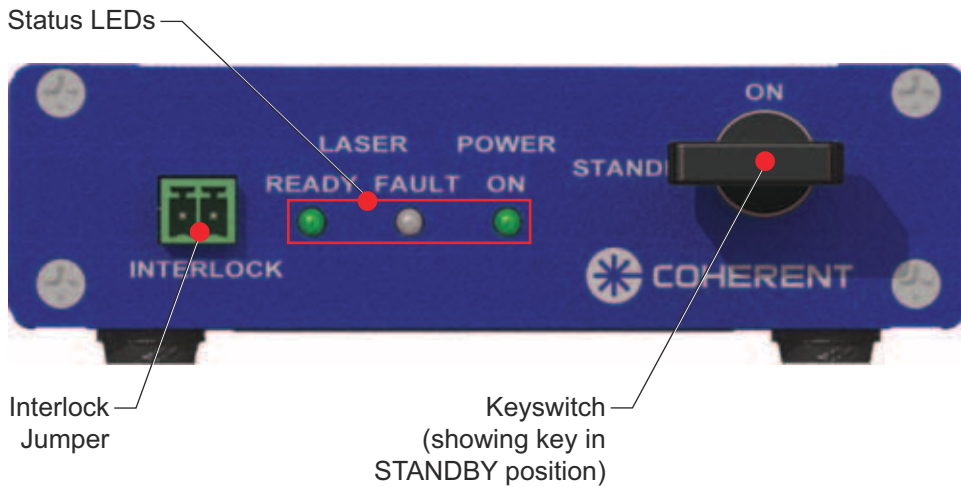

**Figure 4-6. Coherent StingRay Controller Front Panel**

## Keyswitch

This is a single keyswitch master power control for laser emission supply.

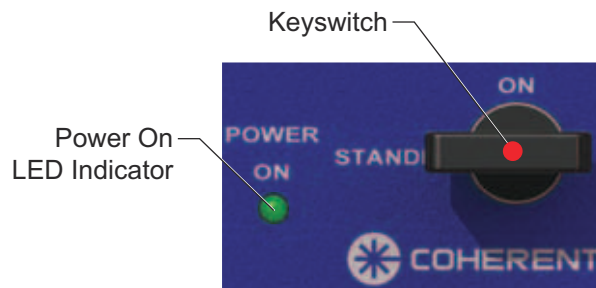

The following illustration shows the keyswitch in the STANDBY and the ON positions.

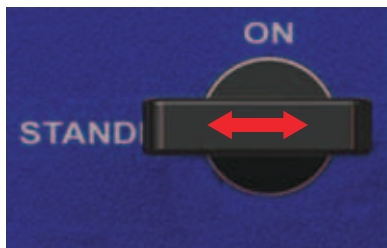

STANDBY Position



ON Position

## Status LED Indicators

There are three Status LEDs on the front panel:

- Laser Ready
- Laser Fault
- Power On



The following table lists all the possible states of the controller Status LEDs.

**Table 4-6. Coherent StingRay Controller Status LED States**

Action	Ready	Fault	On
No power			
Power to Control board			Green
Power to Laser	Green		Green
Interlock disconnect	Red		Green
Interlock reapplied after disconnect (must toggle keyswitch to reset)			Green
Fault	Green	Flashing	

For information on the laser Status LED, refer to Table 2-3 on page 2-3.

## Interlock Jumper

This is a mechanical-style jumper for CDRH interlock. The interlock has terminal style connections that allow connection to an external control device.

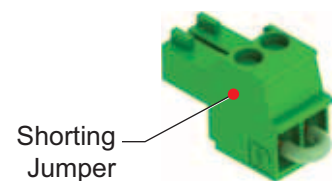

## Back Panel

The back panel of the Coherent StingRay Controller (Figure 4-7, below) has the following connectors: laser head, power in, BNC, and USB.

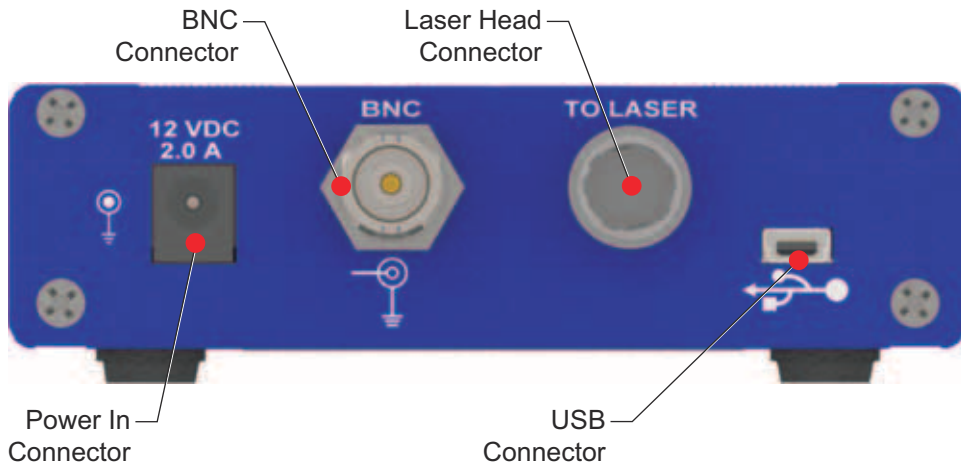

**Figure 4-7. Coherent StingRay Controller Back Panel**

### Laser Head Connector

Use this connector to connect the Coherent StingRay laser to the Controller.



### Power In Connector

Power is supplied to the Coherent StingRay Controller through a 1 mm barrel connector. The Coherent StingRay Controller, in turn, supplies power to the laser head through a 12-pin connector.

A power supply for the Controller can be purchased separately from Coherent (P/N 1105427).

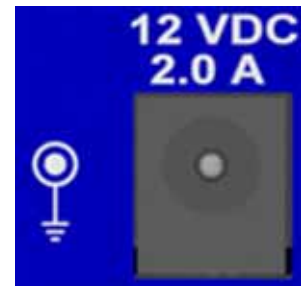

### BNC Connector

The BNC connector provides a path for the modulation signal to pass from an external source to the laser while connected to the Controller. Both Analog and Digital signals can be applied to this connection.



## USB Connector

This Mini-B connector allows you to connect a PC to the Coherent StingRay Controller and issue commands. The commands pass to the laser via RS-232. The controller converts the USB signal to RS-232.



## Specifications

*Table 4-7. Coherent StingRay Controller Specifications (Sheet 1 of 2)*

Parameter	Specification
Coherent StingRay Controller dimensions	84.5 x 108.5 x 30.0 mm
Laser-In connectors	One
Operating temperature range	10 to 50°C
Operating humidity range	30 to 85%
Storage temperature range	-20 to 70°C
Storage humidity range (non-condensing)	30 to 95%
Interlock(s)	One keyswitch One dual pin
Power input	12V $\pm$ 2 VDC
Mechanical expandability	No
Modulation capability	Pass-through only; 50 Ohm
Modulation connectors	One input: pass-through
Modulation connector style	BNC
<b>LEDs</b>	
READY - On conditions	Power to Laser; Fault
FAULT - On conditions	Laser Fault
ON - On conditions	- Power to Controller - Power to Laser - Interlock and Fault conditions
<b>Laser I/O Connector</b>	
1. Laser power	12V $\pm$ 2 VDC
2. Laser power	Connected to Pin 1
3. GND	Ground
4. Communications input	Host input signal - RS-232 signal
5. GND	Ground
6. GND	Ground
7. GND	Ground
8. Communications output	Host output signal - RS-232 signal
9. Modulation GND	Modulation ground
10. Modulation signal	Modulation input signal - Coherent StingRay pass-through
11. GND	Ground
12. Laser fault signal	0V - fault; open collector input

**Table 4-7. Coherent StingRay Controller Specifications (Sheet 2 of 2)**

<b>Parameter</b>	<b>Specification</b>
Communications protocol to laser	RS-232
USB connector	One
Power-In connector	Kycon KLDX-SMT-0202-AP
RS-232 connector	DB-9 standard female
Laser-In connector	Hirose 12-pin HR10A-10R-12PB(72)

## SECTION FIVE: HOST INTERFACE

In this section:

- Host command quick reference (this page)
- Message considerations (p. 5-2)
- Commands and queries (p. 5-5)
- SCPI error codes (p. 5-10)

---

**When a command is sent to the Coherent StingRay laser, the parameter for the command is stored in internal persistent memory, which has a logic cell life of 10 thousand cycles. The cell life sets the limits for repetitive commands sent to the Coherent StingRay laser.**

**This only applies to commands and not queries.**

---

### **Host Command Quick Reference**

The following table gives a brief description of all host commands and queries. For detailed information about a specific command or query, go to the page referenced in the right-hand column.

*Table 5-1. Host Command Quick Reference (Sheet 1 of 2)*

<b>Command</b>	<b>Description</b>	<b>Page No.</b>
*IDN?	Device ID query	5-5
SYST:CDRH	Enables/disables 5-second CDRH delay	5-5
SYST:CDRH?	Queries CDRH delay state	5-5
SYST:COMM:BAUD	Sets serial communication baud rate	5-6
SYST:COMM:BAUD?	Queries serial communication baud rate	5-6
SYST:COMM:HAND	Enables/disables SCPI handshaking	5-6
SYST:COMM:HAND?	Queries SCPI handshaking state	5-6
SYST:COMM:PROM	Enables/disables interactive prompt	5-6
SYST:COMM:PROM?	Queries interactive prompt state	5-6
SYST:DIOD:HOURL?	Queries laser diode usage hours	5-6
SYST:FAUL?	Queries system fault	5-6
SYST:INF:CDAT?	Queries factory calibration date	5-7

**Table 5-1. Host Command Quick Reference (Sheet 2 of 2)**

<b>Command</b>	<b>Description</b>	<b>Page No.</b>
SYST:INF:FVER?	Queries firmware version	5-7
SYST:INF:MDAT?	Queries manufacture date	5-7
SYST:INF:MOD?	Queries Coherent laser model	5-7
SYST:INF:PNUM?	Queries Coherent part number	5-7
SYST:INF:POW?	Queries laser power in Watts at maximum calibrated output	5-7
SYST:INF:SNUM?	Queries serial number	5-7
SYST:INF:USER	Enters and stores user-defined identification	5-7
SYST:INF:USER?	Queries user-defined name	5-7
SYST:INF:WAV?	Queries laser wavelength	5-8
SYST:STAT?	Queries system status	5-8
SOUR:AM:MPOL?	Queries modulation input polarity	5-8
SOUR:AM:SOUR?	Queries device operating mode	5-8
SOUR:AM:STAT	Switches laser on/off	5-8
SOUR:AM:STAT?	Queries laser on/off state	5-8
SOUR:CUR:LEV?	Queries diode operating current	5-8
SOUR:POW:LEV?	Queries diode operating power	5-9
SOUR:POW:LEV:IMM:AMPL	Sets laser output power in Watts for CW power mode	5-9
SOUR:POW:LEV:IMM:AMPL?	Queries laser output power in Watts for CW power mode	5-9
SOUR:POW:NOM?	Queries laser nominal power	5-9
SOUR:TEMP:DIOD?	Queries diode temperature	5-9
SOUR:TEMP:INT?	Queries internal temperature	5-9
SOUR:TEMP:PROT:DIOD:LOW?	Queries laser diode low temperature limit	5-9
SOUR:TEMP:PROT:DIOD:HIGH?	Queries laser diode high temperature limit	5-9

## Message Considerations

### Communication Port Selection

The laser head uses RS-232 serial port for host communications. If the laser head is connected to a Coherent StingRay controller, the communication with host is through USB port. The communication protocol described within this section works identically on either port.



## **Message Completion Handshake**

SCPI message round trip handshaking is implemented on every message sent by the laser head firmware; however, the handshaking may be disabled using an SCPI command. Change of the setting will be saved in non-volatile memory.

This handshake serves several purposes:

1. It provides an indication to the host/controller that the message was received
2. It provides a synchronization mechanism to the host/controller so it will know when a message has been processed to completion so a new message may be sent
3. It provides the host/controller with an indication of any errors that may have occurred.

The handshake is a short message string that is sent as the last action performed when handling a received message. The handshake string represents either an OK response or an error response if a received message raises an error condition.

Note that quotation marks as depicted here are never included in the handshake string.

The OK response is formatted as “OK\r\n”.

Error responses are formatted as “ERR<n>\r\n” where <n> represents the error code number. Negative numbers are permitted in the error string.

When handshaking is enabled, Coherent StingRay devices transmit one of the following handshake reply strings in response to each received command or query:

- Valid commands with valid data parameters will reply with “OK\r\n”
- Valid queries with any optional valid data reply as explicitly defined elsewhere in this section, followed by “OK\r\n”. For example, if querying the model name string, the laser will transmit the model name string followed by the “OK\r\n” string.
- Valid commands or queries which result in an error reply with “ERR<n>\r\n”
- Unrecognized or unsupported commands or queries reply with “ERR-100\r\n”

## **Message Terminators**

Messages between the laser head or controller and the host computer are comprised entirely of ASCII string characters; no binary messages are supported. All message strings passing through the host interface are terminated to signal the end of a message string. The maximum message length supported is 255 bytes, which includes all terminating characters.

## **Messages Received by the Laser**

Messages received by the laser head or controller must be terminated by a carriage return (decimal 13). A line feed (decimal 10) following the carriage return is ignored so messages may be terminated with a carriage return and line feed pair. A command or query is considered incomplete without proper termination.

## **Messages Sent by the Laser**

All messages sent by the laser head or controller are terminated by a carriage return (decimal 13) and line feed (decimal 10) pair. The maximum length of any message sent by the laser is limited to 255 bytes, including all terminating characters.

## **Message Syntax**

Syntax specified by the SCPI and IEEE 488.2 Standards is followed unless otherwise specified. Refer to the SCPI and IEEE 488.2 Standards for more information.

Notably, the base-10 numeric data format specification is used heavily in this document and covered in the IEEE 488.2 Standard. Unless otherwise specified, numeric data items referred to as NRf (IEEE flexible numeric representation) are interchangeable and may be represented in any of these formats:

- integer values
- non-scientific notation floating point values
- scientific notation floating point values (uppercase or lowercase E)

For example, the following data values are functionally equivalent:

- 31256
- 31256.0
- 3.1256E4
- 31.256E3
- +3.1256E+4.

Unless otherwise specified, non-numeric data items (typically referred to as strings) are not quoted.

Devices interpret hexadecimal data using the following rules:

- Uppercase and lowercase are accepted (“FE” is the same as “fe”)
- Leading zeroes are required and accepted (“0A” is the same as “A”)
- The data string may optionally be preceded by a “0x” or “0X” C hexadecimal notation idiom (0xD2C4 is the same as D2C4)
- Following the optional “0x” prefix, the acceptable characters are from the list: 0, 1, 2, 3, 4, 5, 6, 7, 8, 9, a, b, c, d, e, f, A, B, C, D, E, and F

Enumerated values must match exactly, using the long form/short form comparison rules defined under the SCPI Standard.

Dates (manufacturing date, calibration date, etc.) will use the YYYYMMDD format. Using this format, dates may be stored as ASCII strings or as numeric long integers and converted easily from one format to the other.

## Command Prompt

Each device implements the ability to output a command prompt to support interactive operation by an operator typing commands in a terminal program. A command has been specified to describe the command prompt behavior.

## Commands and Queries

**\*IDN?**

Device ID query.

Query: \*IDN?

Return: Coherent, Inc - StingRay - <firmware version> - <firmware build date>

**SYST:CDRH**



---

***NOTICE!***

**Disabling the CDRH delay will render the Coherent StingRay system non-CDRH compliant.**

---

5-second CDRH delay control command (persistent).

Command: SYST:CDRH {ON|OFF}

Query: SYST:CDRH?

**SYST:COMM:BAUD**

Serial communication baud rate control command (persistent).

Command: SYST:COMM:BAUD <baud rate>

Query: SYST:COMM:BAUD?

Note: Default = 115200.

**SYST:COMM:HAND**

SCPI handshaking control command (persistent).

Command: SYST:COMM:HAND {ON|OFF}

Query: SYST:COMM:HAND?

**SYST:COMM:PROM**

Interactive prompt control command (persistent).

Command: SYST:COMM:PROM {ON|OFF}

Query: SYST:COMM:PROM?

**SYST:DIOD:HOURL?**

Queries laser diode usage hour.

Query: SYST:DIOD:HOURL?

Return: Hours in x.xx format.

Note: The usage hours are saved to persistent memory every 15 minutes.

**SYST:FAUL?**

System fault query - returns bit-coded fault conditions.

Query: SYST:FAUL?

The following table describes fault code bit mapping.

**Table 5-2. Fault Bit Codes**

Bit	Mask	Bit Label	Definition
1	2	Diode Temperature Fault	Diode temperature out of range
2	4	Internal Temperature Fault	Internal temperature out of range
4	10	I2C Error	I2C bus error
5	20	Over Current	Diode over current
6	40	Laser Checksum Error	Persistent memory checksum error
17	20000	Watchdog Timer Reset	Firmware resumed from watchdog reset
19	80000	Diode End of Life	Laser diode reaches end of life

**SYST:INF:CDAT?**

Queries factory calibration date.

Query: SYST:INF:CDAT?

**SYST:INF:FVER?**

Queries firmware version.

Query: SYST:INF:FVER?

Return: Version in format VX.X.X.

**SYST:INF:MDAT?**

Queries manufacture date.

Query: SYST:INF:MDAT?

**SYST:INF:MOD?**

Queries Coherent laser model.

Query: SYST:INF:MOD?

Return: "STINGRAY" as default.

**SYST:INF:PNUM?**

Queries Coherent part number.

Query: SYST:INF:PNUM?

**SYST:INF:POW?**

Queries laser power in Watts at maximum calibrated output.

Query: SYST:INF:POW?

**SYST:INF:SNUM?**

Queries serial number.

Query: SYST:INF:SNUM?

**SYST:INF:USER**

Enters and stores user-defined identification (persistent). Queries user-defined name.

Command: SYST:INF:USER {0,<character string>}

Query: SYST:INF:USER?

Return: "STINGRAY" as default.

**SYST:INF:WAV?**

Queries laser wavelength in nanometers.

Query: SYST:INF:WAV?

**SYST:STAT?**

System status query.

Query: SYST:STAT?

Return: Bit-coded laser operational status.

The following table describes status code bit mapping.

**Table 5-3. Status Code Bit Definitions**

Bit	Mask	Bit Label	Definition
0	1	Laser Fault	Any laser faults
1	2	Laser Emission	Laser emission status
2	4	Laser Ready	Laser ready status
3	8	Laser Standby	Laser standby status
4	10	CDRH Delay	Laser CDRH delay status
5	20	Laser Hardware Fault	Any hardware faults

**SOUR:AM:MPOL?**

Queries modulation input polarity control command (persistent) (ON = PASS, OFF = INVERT).

Query: SOUR:AM:MPOL?

**SOUR:AM:SOUR?**

Queries device operating mode (constant power, external analog, digital, or fast digital modulation).

Query: SOUR:AM:SOUR?

**SOUR:AM:STAT**

Laser on/off control command.

Command: SOUR:AM:STAT {ON|OFF}

Query: SOUR:AM:STAT?

**SOUR:CUR:LEV?**

Queries diode operating current in Amps.

Query: SOUR:CUR:LEV?

**SOUR:POW:LEV?**

Queries diode operating power in Watts.

Query: SOUR:POW:LEV?

**SOUR:POW:LEV:IMM:AMPL**

Laser output power control command for CW power mode (persistent).

Command: SOUR:POW:LEV:IMM:AMPL <laser power in Watts>}

Query: SOUR:POW:LEV:IMM:AMPL?

**SOUR:POW:NOM?**

Queries laser nominal power in Watts.

Query: SOUR:POW:NOM?

**SOUR:TEMP:DIOD?**

Queries diode temperature.

Query: SOUR:TEMP:DIOD?

Return: Value in Celsius degrees.

**SOUR:TEMP:INT?**

Queries laser internal temperature.

Query: SOUR:TEMP:INT?

Return: Value in Celsius degrees.

**SOUR:TEMP:PROT:DIOD:LOW?**

Queries laser diode low temperature limit (degrees C).

Query: SOUR:TEMP:PROT:DIOD:LOW?

**SOUR:TEMP:PROT:DIOD:HIGH?**

Queries laser diode high temperature limit (degrees C).

Query: SOUR:TEMP:PROT:DIOD:HIGH?

## SCPI Error Codes

*Table 5-4. SCPI Error Codes*

<b>Error</b>	<b>Code</b>
SCPI_ERROR_QUEUE_OVERFLOW	-350
SCPI_ERROR_SYSTEM_ERROR	-310
SCPI_ERROR_NONE	0
SCPI_ERROR_UNRECOGNIZED	100
SCPI_ERROR_INVALID_PARAM	101
SCPI_ERROR_DATA_ERROR	102



## SECTION SIX: PRODUCT REPAIR

Each Coherent StingRay laser has been designed to exhibit proper mechanical and temperature stability. As such, no user-serviceable parts are located inside the laser. **Do not attempt to take the assembly apart—this will void the product warranty.**

---

***NOTICE!***

**Coherent recommends that the shipping box and packing materials be saved after initial purchase, as they will be required should the laser need to be shipped or returned.**

---

### ***Product Shipping Instructions***

To prepare the product for shipping:

1. Repack the laser in the packaging insert.
2. Repack the insert into the original shipping box.
3. Close the box and tape it securely.
4. Obtain a Coherent RMA number by contacting our Technical Support Hotline at 1.800.367.7890 (1.408.764.4557 outside the U.S.), or by e-mailing [Product.Support@Coherent.com](mailto:Product.Support@Coherent.com).
5. Fill out a shipping label and attach it to the outside of the box. ***Make sure to include the Coherent RMA number on the shipping label.***



## APPENDIX A: WARRANTY

Each Coherent StingRay laser has been designed to exhibit proper mechanical and temperature stability. As such, no user-serviceable parts are located inside the laser. **Do not attempt to take the assembly apart, as any such action will void the product warranty.**

Coherent StingRay lasers are guaranteed to be free from material and manufacturing defects for a period of two years from the date of shipment, with the exception of products that have a wavelength < 635 nm, which have a warranty of one year. Should a product fail during this period, Coherent will, at its discretion, repair or replace the damaged unit. Repaired or replacement units will be covered for the remainder of the original equipment warranty period. The warranty does not apply to units examined by Coherent that are found to have failed due to abuse, acts of nature, mishandling, alteration, improper installation, or negligence.



# GLOSSARY

## **ANSI**

American National Standards Institute. An organization that generates the ANSI Z136.1 Standard for the Safe Use of lasers and other safety standards for laser users.

## **Collimation**

The process by which a divergent beam of radiation is converted to a parallel beam. A diode laser focused at more than about 45 inches is said to be “collimated” for all practical purposes.

## **CCD**

Acronym for **Charged Couple Device**. In common terms, it is the semiconductor chip that is used to collect light and convert it into a digital image. The conversion process involves grabbing the collected light from small sections of the chip in a continuous fashion similar to a television screen. The data is typically taken every 1/30<sup>th</sup> of a second.

## **CDRH**

Center for Devices and Radiological Health. A regulatory organization that publishes legal regulations for laser product manufacturers, applicable in the U.S.

## **CW**

An acronym for Continuous Wave. A term used to describe the output of a laser emitting radiation continuously rather than in short bursts.

## **Depth-of-Field**

The physical distance one can move the image plane (+/-) without affecting the focused image sharpness by more than 1.4 times its smallest size.

## **Fan Angle**

The (full) angle at which light “fans out” from the front of the laser, to form the image. Used to determine the “length” of a projected line at a fixed distance from the laser source.

## **IEC**

International Electrotechnical Commission. An organization that publishes the IEC 60825-1 laser safety standard.

## **Infrared (IR)**

The invisible portion of the electromagnetic spectrum that lies between 0.75 and 1000  $\mu\text{m}$ . All IR Coherent StingRay lasers emit in the region of 780 nm to 1550 nm (near IR).

## **Interbeam Angle**

The interbeam angle is the angle between two diverging light images from a single source. It is used to determine how far apart the projections (that is, dots, lines, etc.) will be from one another at a distance D from the source.

## **Modulation**

A change in the output level generated by a change in supplied voltage.

## **Nanometer**

A unit of length in the metric system equal to 10<sup>-9</sup> meter.

**Structured Light**

A term used in Machine Vision applications to describe any light source that projects a known geometric distribution of light.

**Visible**

The region of the electromagnetic spectrum which is visible by the human eye. Light in the visible region falls between 400 and 700 nm.

**Wavelength**

Electromagnetic energy is transmitted in the form of a sinusoidal wave. The wavelength is the physical distance covered by one cycle of this wave. Wavelength is inversely proportional to the frequency.

# INDEX

## C

- Cap, protecting device 1-2
- Classification
  - Laser 1-3
  - Laser requirements 1-7
- Cleaning
  - Diffraction Gratings 3-3
  - Optics 3-2
- Coherent StingRay and RS-232 2-8
- Coherent StingRay laser, servicing 3-1
- Commands and queries 5-5
- Communication port selection 5-2
- Compliance, U.S. export control laws -vi

## D

- Declaration of conformity 1-8
- Diffraction gratings, cleaning 3-3

## E

- Error codes, SCPI 5-10

## F

- Focusing
  - Coherent StingRay lasers 3-2
  - Lasers 3-2

## H

- Hints, operating 3-3
- Host
  - Command quick reference 5-1
  - Interface 5-1

## I

- Incoming inspection -ix
- Inspection, incoming -ix

## L

- Laser
  - Classification 1-3
  - Classification requirements 1-7
  - Controller with remote interlock for class IIIb lasers, protecting device 1-2
  - Declaration of conformity 1-8
  - Operating environment 2-6
  - Safety 1-1
  - Safety and classification 1-3
  - Turning off 2-4
  - Turning on 2-2
- Lasers
  - Focusing 3-2
  - Focusing Coherent StingRay 3-2
  - With a controller 2-4

## M

- Message
  - Completion handshake 5-3
  - Syntax 5-4
  - Terminators 5-4
- Message considerations
  - Communication port selection 5-2
  - Message completion handshake 5-3
  - Message syntax 5-4
  - Message terminators 5-4
- Modulating the laser 2-4

## O

- Operating
  - Environment, laser 2-6
  - Hints 3-3
- Optics, cleaning 3-2

## P

- Power requirements 2-2
  - 115 or 220 VAC operation 2-2
- Product
  - Repair 6-1
  - Shipping instructions 6-1
- Protecting devices 1-1
  - Cap 1-2
  - Laser controller with remote interlock for class IIIb lasers 1-2

## Q

- Quick reference, host command 5-1

## R

- Repair, product 6-1
- RS-232 and Coherent StingRay 2-8

## S

- Safety, laser 1-1
- SCPI error codes 5-10
- Servicing your Coherent StingRay laser 3-1
- Shipping instructions, product 6-1
- Signal words and symbols in this manual -vii

## T

- Turning the laser
  - Off 2-4
  - On 2-2

## U

- U.S. export control laws compliance -vi

## W

- Warranty A-1







