

VP series

User Manual

English

VP-31MC-M/C 26 H

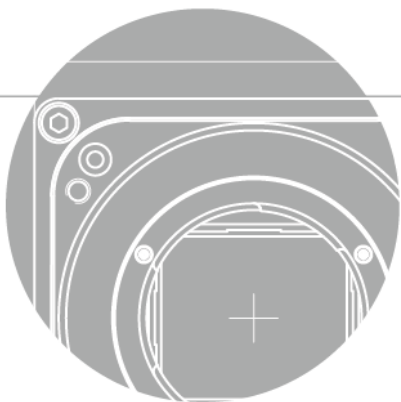

VIEWWORKS

Revision History

Version	Date	Description
1.0	2021-03-31	Initial Release

Contents

1	Precautions	6
2	Warranty	7
3	Compliance & Certifications	7
3.1	FCC Compliance.....	7
3.2	CE: DoC.....	7
3.3	KC.....	7
4	Package Component	8
5	Product Specifications	9
5.1	Overview.....	9
5.2	Specifications.....	10
5.3	Camera Block Diagram.....	12
5.4	Spectral Response.....	13
5.4.1	Monochrome Spectral Response.....	13
5.4.2	Color Spectral Response.....	14
5.5	Mechanical Specification.....	15
5.5.1	Camera Mounting and Heat Dissipation.....	16
6	Connecting the Camera	17
6.1	Precaution to Center the Image Sensor.....	18
6.2	Precaution about Blurring Compared to the Center.....	18
6.3	Controlling the Camera.....	18
7	Camera Interface	19
7.1	General Description.....	19
7.2	Camera Link SDR Connector.....	19
7.3	Power Input Receptacle.....	23
7.4	Control I/O Receptacle.....	24
7.5	Trigger Input Circuit.....	25
7.6	Strobe Output Circuit.....	25
8	Acquisition Control	26
8.1	Overview.....	26
8.2	Acquisition Start/Stop Commands and Acquisition Mode.....	29

8.3	Exposure Start Trigger	31
8.3.1	Trigger Mode	31
8.3.2	Using a Software Trigger Signal.....	35
8.3.3	Using a CC1 Trigger Signal.....	36
8.3.4	Using an External Trigger Signal.....	37
8.3.5	Exposure Mode	39
8.3.6	Short Exposure Mode.....	41
8.3.7	Exposure Offset.....	42
8.4	Setting the Exposure Time	43
8.5	Overlapping Exposure with Sensor Readout.....	44
8.6	Global Shutter	46
8.7	Maximum Allowed Frame Rate.....	47
8.7.1	Increasing the Maximum Allowed Frame Rate.....	48
9	Camera Features	49
9.1	Image Region of Interest.....	49
9.2	Multi-ROI.....	52
9.3	Binning (Monochrome Only).....	55
9.4	Frame Averaging.....	57
9.5	Pixel Format.....	58
9.6	Device Tap Geometry.....	59
9.7	Camera Link Clock.....	60
9.8	Data ROI (Color Camera).....	61
9.9	White Balance (Color Camera).....	62
9.9.1	Balance White Auto	62
9.10	Gain and Black Level	63
9.11	Defective Pixel Correction	64
9.11.1	Correction Method	64
9.12	Photo Response Non-uniformity Correction	65
9.12.1	Generating and Saving User PRNU Correction Values	66
9.13	Flat Field Correction.....	67
9.13.1	Flat Field Data Selector.....	71
9.14	Digital I/O Control.....	72
9.14.1	Debounce	74
9.15	Timer Control	75
9.16	Cooling Control	77
9.17	Temperature Monitor	78

9.18 Status LED.....	78
9.19 Test Pattern.....	79
9.20 Reverse X.....	82
9.21 Reverse Y.....	83
9.22 Device User ID.....	84
9.23 Device Reset.....	84
9.24 Field Upgrade.....	84
9.25 User Set Control.....	85
9.26 Sequencer Control.....	87
10 Camera Configuration.....	90
10.1 Serial Communication.....	90
10.2 Actual Runtime of Parameters.....	90
10.3 Configurator.....	91
10.3.1 Starting the Configurator.....	91
10.4 Command List.....	94
11 Troubleshooting.....	103
Appendix A Defective Pixel Map Download.....	104
Appendix B Field Upgrade.....	106

1 Precautions

General



- Do not drop, disassemble, repair or alter the device. Doing so may damage the camera electronics and cause an electric shock.
- Do not let children touch the device without supervision.
- Stop using the device and contact the nearest dealer or manufacturer for technical assistance if liquid such as water, drinks or chemicals gets into the device.
- Do not touch the device with wet hands. Doing so may cause an electric shock.
- Make sure that the temperature of the camera does not exceed the temperature range specified in [5.2 Specifications](#). Otherwise the device may be damaged by extreme temperatures.

Installation and Maintenance



- Do not install in dusty or dirty areas - or near an air conditioner or heater to reduce the risk of damage to the device.
- Avoid installing and operating in an extreme environment where vibration, heat, humidity, dust, strong magnetic fields, explosive/corrosive mists or gases are present.
- Do not apply excessive vibration and shock to the device. This may damage the device.
- Avoid direct exposure to a high intensity light source. This may damage the image sensor.
- Do not install the device under unstable lighting conditions. Severe lighting change will affect the quality of the image produced by the device.
- Do not use solvents or thinners to clean the surface of the device. This can damage the surface finish.

Power Supply



- Applying incorrect power can damage the camera. If the voltage applied to the camera is greater or less than the camera's nominal voltage, the camera may be damaged or operate erratically. Please refer to [5.2 Specifications](#) for the camera's nominal voltage.
 - ※ Vieworks Co., Ltd. does NOT provide power supplies with the device.
- Make sure the power is turned off before connecting the power cord to the camera. Otherwise damage to the camera may result.

2 Warranty

Do not open the housing of the camera. The warranty becomes void if the housing is opened.

For information about the warranty, please contact your local dealer or factory representative.

3 Compliance & Certifications

3.1 FCC Compliance

This equipment has been tested and found to comply with the limits for a Class A digital device, pursuant to part 15 of the FCC Rules. These limits are designed to provide reasonable protection against harmful interference when the equipment is operated in a commercial environment. This equipment generates, uses, and can radiate radio frequency energy and, if not installed and used in accordance with the instruction manual, may cause harmful interference to radio communications. Operation of this equipment in a residential area is likely to cause harmful interference in which case the user will be required to correct the interference at his own expenses.

3.2 CE: DoC

EMC Directive 2014/30/EU

EN 55032:2012 (Class A), EN 55024:2010

Class A

3.3 KC

KCC Statement

Type	Description
Class A (Broadcasting Communication Device for Office Use)	This device obtained EMC registration for office use (Class A), and may be used in places other than home. Sellers and/or users need to take note of this.

4 Package Component

Package Component

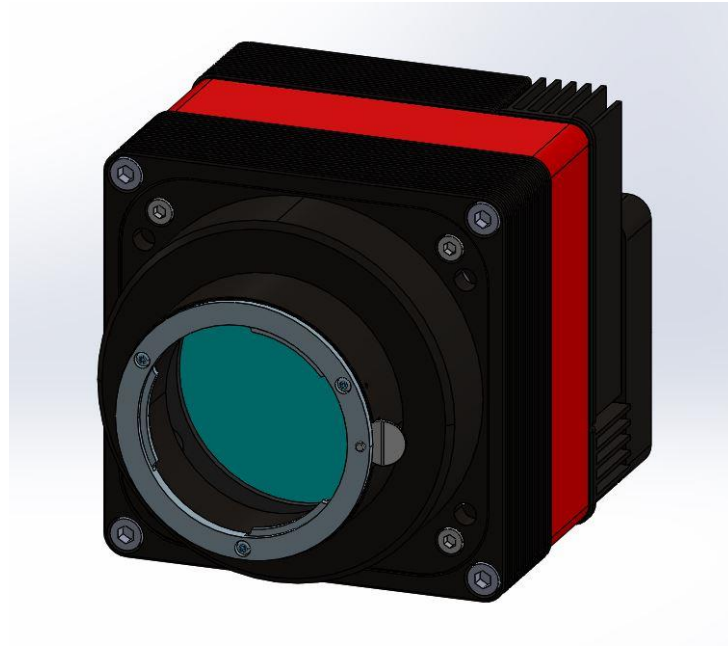

VP-31MC-26 H <F-mount>

5 Product Specifications

5.1 Overview

The VP-31MC-26 H, the latest model of the industrial proven VP series, is a new 31-megapixel resolution CMOS camera available with the Camera Link interface. This camera is based on the latest CMOS image sensor technology (IMX342) from Sony Semiconductor Solutions Corporation. The VP-31MC-26 H offers up to 26.2 frames per second at 6464 × 4852 resolution. This camera uses thermo-electric Peltier (TEC) cooling technology developed for and used by many demanding medical market customers. The TEC maintains the operating temperature of the image sensor at up to $15\pm 2^{\circ}\text{C}$ below ambient temperature. The VP-31MC camera provides a stable operating condition and the ability to expose for a long period of time to increase the camera's sensitivity. Featuring high-speed and high-resolution with stable performance, this camera is ideal for demanding applications such as FPD, PCB and semiconductor inspections.

Main Features

- High Speed 31 Megapixel CMOS Image Sensor
- Thermoelectric Peltier Cooling – about $15\pm 2^{\circ}\text{C}$ below ambient temperature
- Minimizing the number of hot pixels with TEC
- Electronic Exposure Time Control (Global Shutter)
- Output Pixel Format: 8 / 10 / 12 bit
- Line Output
- Defective Pixel Correction
- Frame Averaging
- Camera Link Base / Medium / Full / 10 Tap
- Camera Link Tap Geometry: 2 Tap, 4 Tap, 8 Tap, 10 Tap
- Camera Link Clock Frequency Selector
- Gain / Black Level Control
- Test Image
- Temperature Monitor
- Field Upgrade
- PRNU Correction
- Flat Field Correction with Sequencer Control
- Hot Pixel Correction
- GenICam Compatible – XML based Control

5.2 Specifications

The technical specifications of the VP-31MC camera are as follows.

Specifications		VP-31MC-M/C 26 H
Active Image (H × V)		6464 × 4852
Sensor		Sony IMX342
Sensor Type		Global Shutter CMOS Image Sensor
Optical Format (Diagonal)		APS-C (27.9 mm)
Pixel size		3.45 μm × 3.45 μm
Interface		Camera Link Base / Medium / Full / 10 Tap
Electronic Shutter		Global Shutter
Max. Frame Rate	2 Tap	5.3 fps
	4 Tap	10.6 fps
	8 Tap	21.1 fps
	10 Tap	26.2 fps
Pixel Data Format	Mono	Mono 8 / Mono 10 / Mono 12
	Color	RG Bayer 8 / RG Bayer 10 / RG Bayer 12
Camera Link Pixel Clock		65 MHz / 85 MHz
Exposure Time		2.4 μs ~ 60 s
Partial Scan (Max. Speed)		1442.3 fps at 4 Lines
Binning	Sensor	×1, ×2 (Horizontal and Vertical Dependent)
Black Level Control		0 ~ 255 LSB at 12 bit
Gain Control		1× ~ 32×
Trigger Synchronization		Free-Run, Hardware Trigger, Software Trigger, CC1 or User Output0
External Trigger		3.3 V ~ 24.0 V, 10 mA, Logical level input, Optically isolated
Software Trigger		Asynchronous, Programmable via Camera API
Dynamic Range		72 dB
Lens Mount		F-mount
Cooling Method		Thermoelectric Peltier Cooling
Cooling Performance		15±2°C below ambient temperature – Standard cooling with a fan

Table 5.1 Specifications of VP-31MC-26 H (continuous)

Specifications		VP-31MC-M/C 26 H
Power	External	11 ~ 24 V DC
	Dissipation	Typ. 30.0 W
Environmental		Operating: 0 ~ 40°C, Storage: -40°C ~ 70°C
Dimension / Weight		90.0 mm × 90.0 mm × 129.3 mm, 1256.1 g (with F-mount)
Configuration SW		Configurator / Vieworks Imaging Solution 7.X

Table 5.2 Specifications of VP-31MC-26 H

5.3 Camera Block Diagram

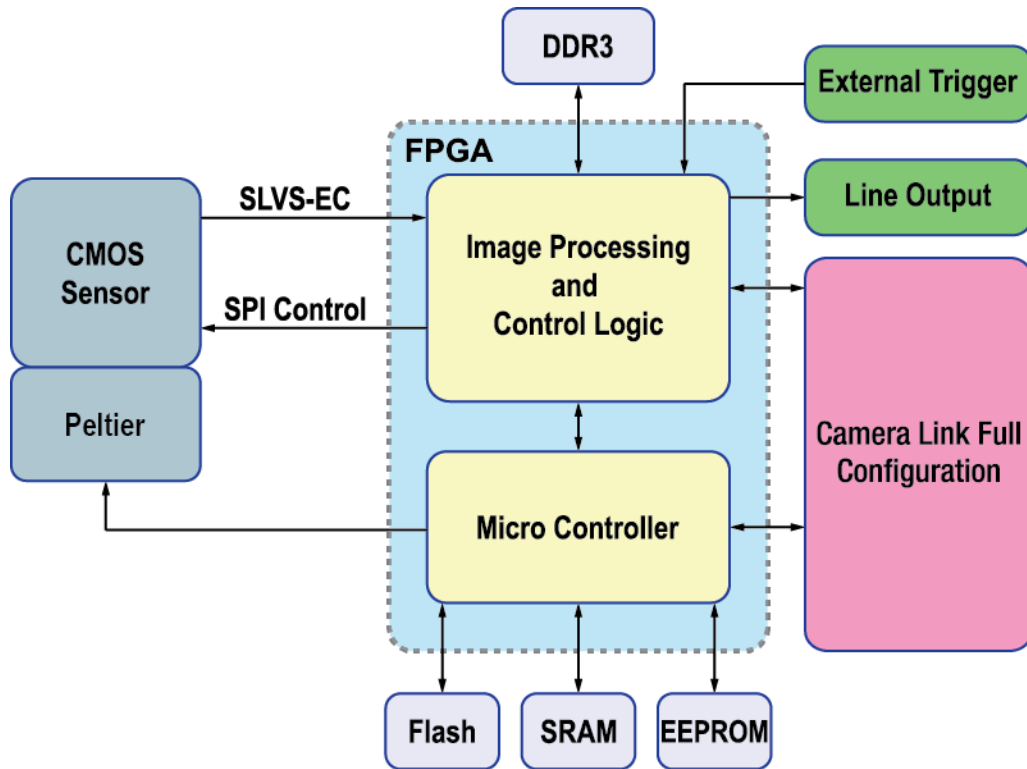

Figure 5.1 Camera Block Diagram

All controls and data processing of the VP-31MC camera are carried out in one FPGA chip.

The FPGA generally consists of a 32-bit RISC Micro-Controller and Processing & Control logic. The Micro-Controller receives commands from the user through the Camera Link interface and then processes them.

The Processing & Control logic processes the image data received from the CMOS image sensor and then transmits data through the Camera Link interface. The Processing & Control logic also controls time-sensitive trigger inputs and output signals. Furthermore, Flash and DDR3 are installed outside FPGA. The DDR3 is used to process images and the Flash stores the firmware to operate the Micro-Controller.

5.4 Spectral Response

5.4.1 Monochrome Spectral Response

The following graph shows the spectral response of the VP-31MC-26 H monochrome camera.

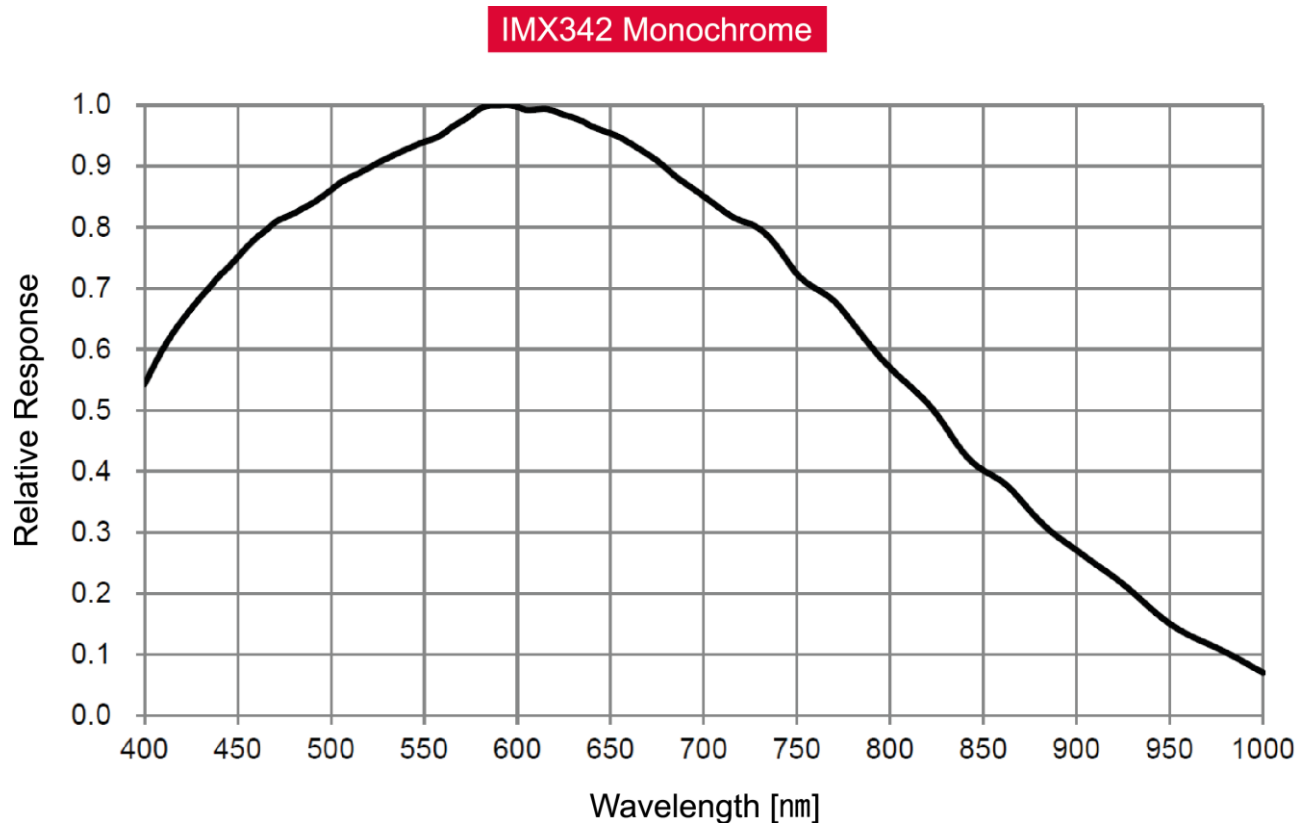

Figure 5.2 VP-31MC-M26 H Spectral Response

5.4.2 Color Spectral Response

The following graph shows the spectral response of the VP-31MC-26 H color camera.

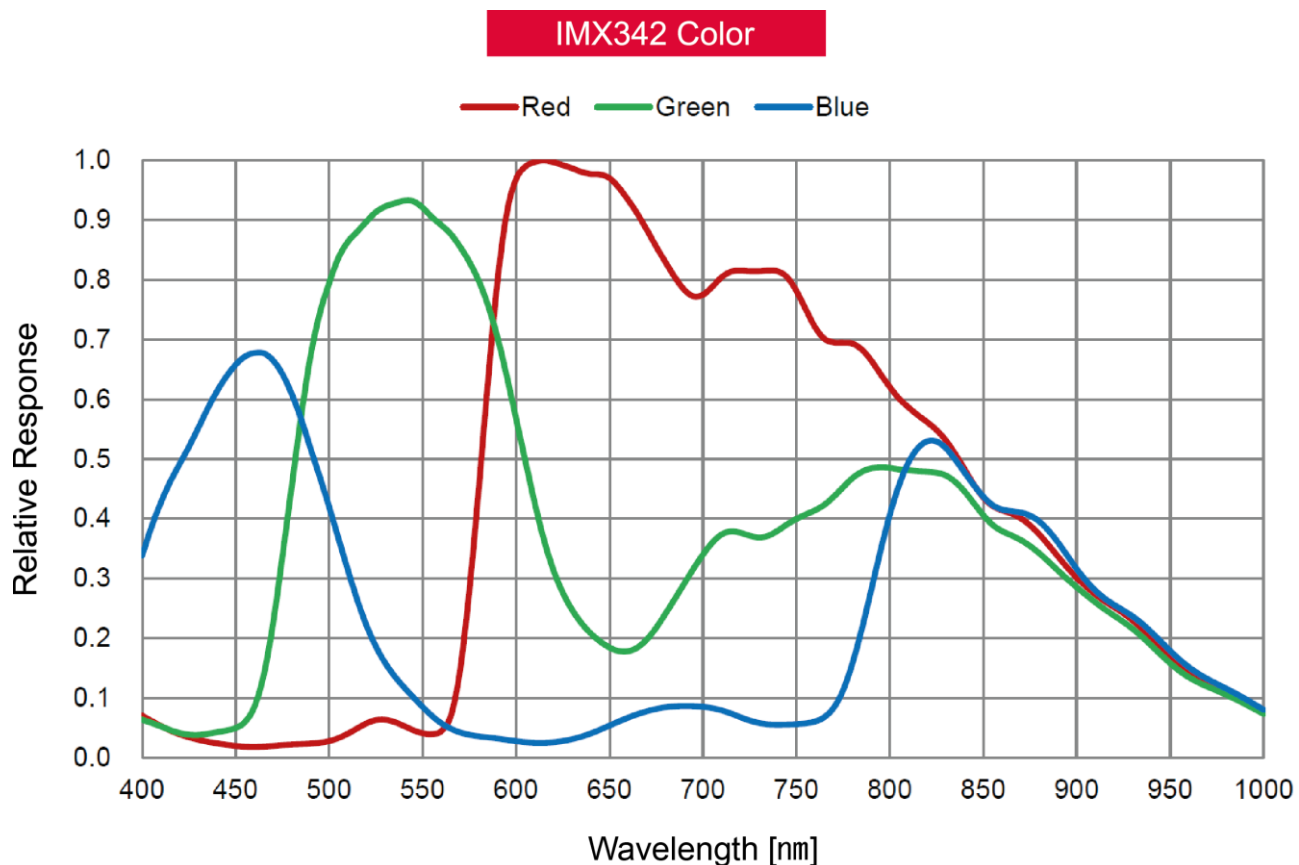

Figure 5.3 VP-31MC-C26 H Spectral Response

5.5 Mechanical Specification

The camera dimensions in millimeters are shown in the following figures.

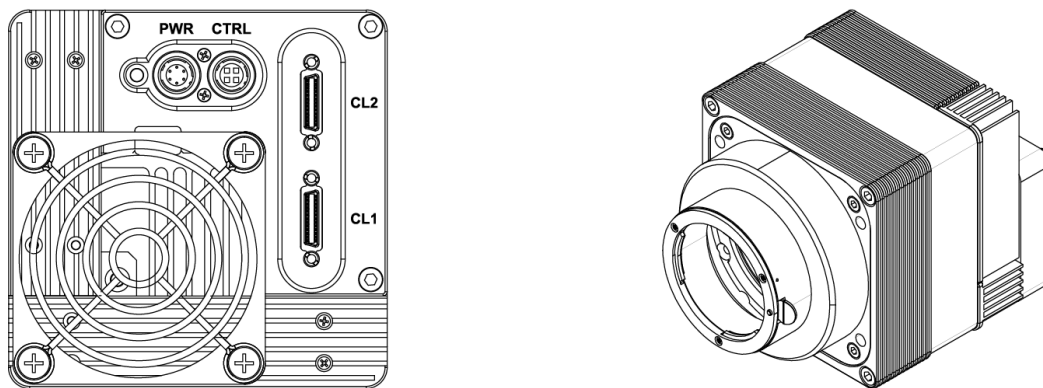
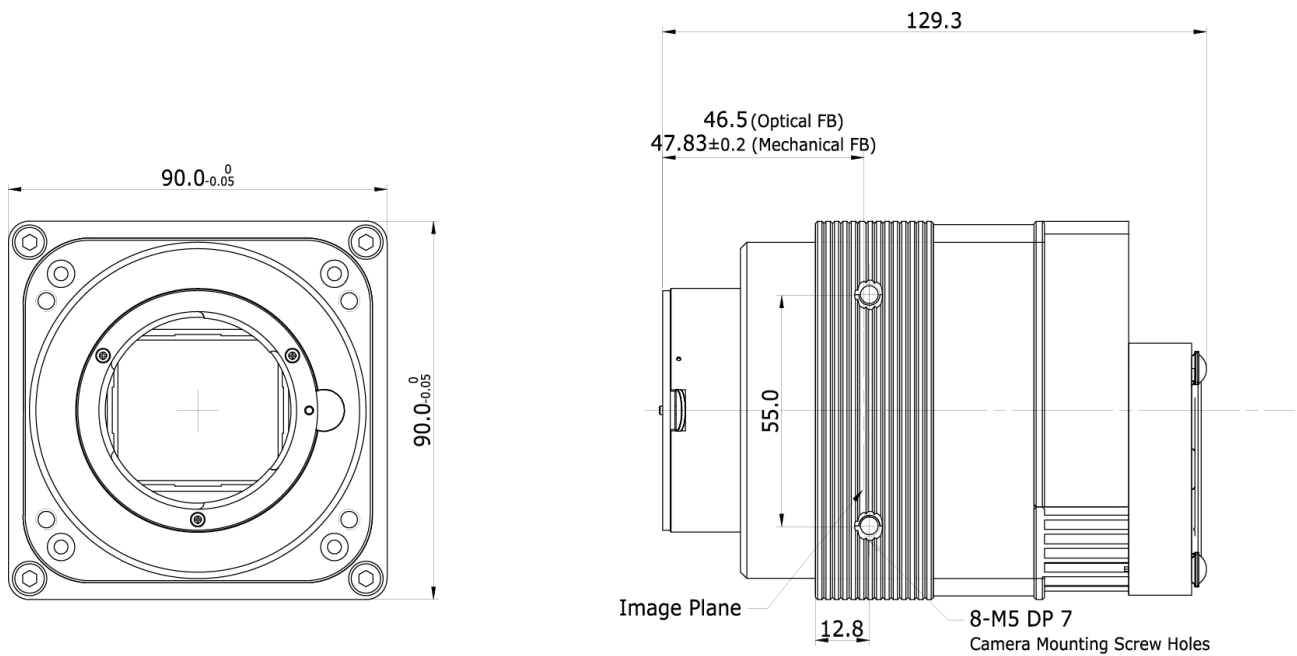

Figure 5.4 Mechanical Dimension for VP-31MC-26 H F-mount

5.5.1 Camera Mounting and Heat Dissipation

Camera Mounting Recommendations for Antivibration

When you mount a camera in a poor condition, the fan equipped on the camera may amplify vibrations which can lead to blurry images. Follow the instructions below to prevent and/or reduce vibrations caused by the fan.

- Fix the camera's front or side surface by using at least four screws.
- Prevent ingress of foreign objects between the camera and system surfaces.
- Keep the camera's center of gravity as near as possible to the system's center of gravity.
- If your lens' weight or size is greater than the camera's, make and use proper mounting brackets to support the lens.
- Prevent foreign matters from falling into the fan. This may cause damage to the fan blades.

Camera Mounting Recommendations for Effective Heat Dissipation

- Do not obstruct the air inlets and outlets of the fan.
- If the fan is not available, leave enough space around the heat sink so that heat can be easily dissipated through the heat sink by natural convection.
- If the fan is not available, mount the camera on a metal structure made of high thermal conductive materials (e.g. Aluminum) to properly dissipate the heat generated by the camera.
- The contact surface of the camera must be at least 30% of the camera's Front-Block.

6 Connecting the Camera

The following instructions assume that you have installed a Camera Link frame grabber (hereinafter 'CL frame grabber) in your computer including related software. For more information, refer to your CL frame grabber user manual.

To connect the camera to your computer, follow the steps below:

1. Make sure that the power supply is not connected to the camera and your computer is turned off.
2. Plug one end of a Camera Link cable into the Camera Link1 connector on the camera and the other end of the Camera Link cable into the Base connector on the CL frame grabber.
3. Plug one end of the other Camera Link cable into the Camera Link2 connector on the camera and the other end of the Camera Link cable into the Medium/Full connector on the CL frame grabber.
4. Connect the plug of the power adapter to the power input receptacle on the camera.
5. Plug the power adapter into a working electrical outlet.
6. Verify all the cable connections are secure.

Precautions for using Camera Link Medium / Full / 10 Tap Configuration



The VP-31MC-26 H camera supports the Camera Link Base / Medium / Full / 10 Tap configuration. To operate the camera in the medium, full or 10 tap configuration, you must connect the camera to the CL frame grabber using two Camera Link cables. Make sure that you connect both Camera Link1 (Base) and Camera Link2 (Medium/Full) connectors on the camera to their respective connectors on the CL frame grabber.

6.1 Precaution to Center the Image Sensor

- User does not need to center the image sensor as it is adjusted as factory default settings.
- When you need to adjust the center of the image sensor, please contact your local dealer or the manufacturer for technical assistance.

6.2 Precaution about Blurring Compared to the Center

- User does not need to adjust the tilt as it is adjusted as factory default settings.
- If the tilt settings need to be adjusted inevitably, please contact your local dealer or the manufacturer for technical support.

6.3 Controlling the Camera

- You can control the camera by using the Configurator.
- You can download the latest Configurator at <http://www.vieworks.com>.
- Please refer to your CL frame grabber user manual.

7 Camera Interface

7.1 General Description

As shown in the following figure, four types of connectors and an LED indicator are located on the back of the camera and have the functions as follows:

- ① Status LED: displays power status and operation mode.
- ② 6 pin Power Input Receptacle: supplies power to the camera.
- ③ 4 pin Control I/O Receptacle: provides access to the camera's I/O lines.
- ④ 26 pin SDR Connector 2(Camera Link Medium/Full): transmits video data.
- ⑤ 26 pin SDR Connector 1(Camera Link Base): transmits video data and controls the camera.

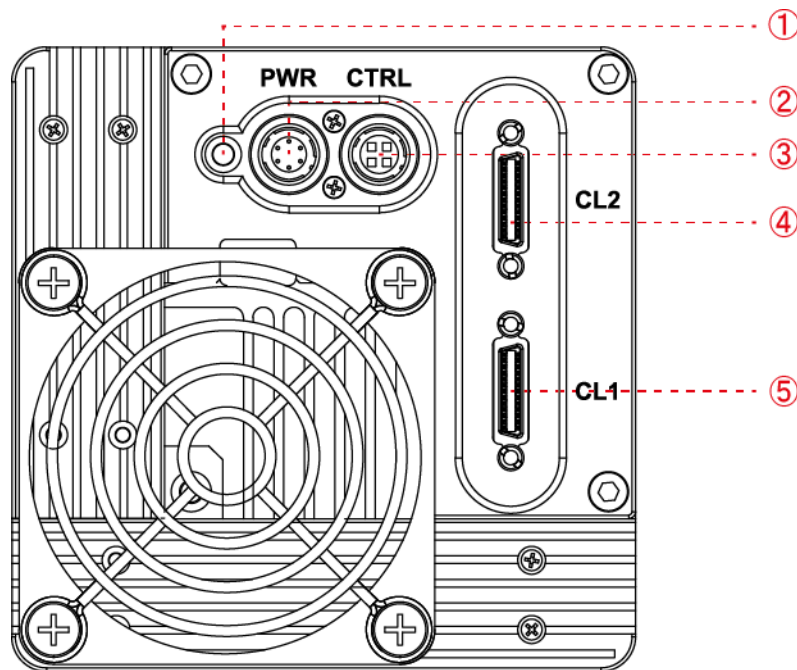

Figure 7.1 VP-31MC-26 H Back Panel

7.2 Camera Link SDR Connector

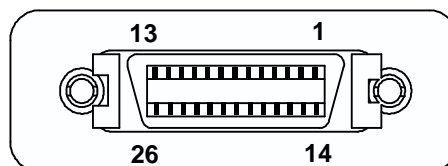

Figure 7.2 Camera Link Connector

The Camera Link connectors on the camera comply with the Camera Link standard and the following lists show the pin assignments of the connectors.

PAIR List	Pin	Signal Name	Type	Description
PAIR 0	1	Ground	Ground	Cable Shield
	14	Ground	Ground	Cable Shield
PAIR 1	2	-X0	LVDS - Out	Camera Link Transmitter
	15	+X0	LVDS - Out	Camera Link Transmitter
PAIR 2	3	-X1	LVDS - Out	Camera Link Transmitter
	16	+X1	LVDS - Out	Camera Link Transmitter
PAIR 3	4	-X2	LVDS - Out	Camera Link Transmitter
	17	+X2	LVDS - Out	Camera Link Transmitter
PAIR 4	5	-XCLK	LVDS - Out	Camera Link Transmitter
	18	+XCLK	LVDS - Out	Camera Link Transmitter
PAIR 5	6	-X3	LVDS - Out	Camera Link Transmitter
	19	+X3	LVDS - Out	Camera Link Transmitter
PAIR 6	7	+ SerTC	LVDS - In	Serial Data Receiver
	20	- SerTC	LVDS - In	Serial Data Receiver
PAIR 7	8	- SerTFG	LVDS - Out	Serial Data Transmitter
	21	+ SerTFG	LVDS - Out	Serial Data Transmitter
PAIR 8	9	- CC 1	LVDS - In	Software External Trigger
	22	+ CC 1	LVDS - In	Software External Trigger
PAIR 9	10	N/C	N/C	N/C
	23	N/C	N/C	N/C
PAIR 10	11	N/C	N/C	N/C
	24	N/C	N/C	N/C
PAIR 11	12	N/C	N/C	N/C
	25	N/C	N/C	N/C
PAIR 12	13	Ground	Ground	Cable Shield
	26	Ground	Ground	Cable Shield

Table 7.1 Pin Assignments for Camera Link Connector 1

PAIR List	Pin	Signal Name	Type	Description
PAIR 0	1	Ground	Ground	Cable Shield
	14	Ground	Ground	Cable Shield
PAIR 1	2	-Y0	LVDS - Out	Camera Link Transmitter
	15	+Y0	LVDS - Out	Camera Link Transmitter
PAIR 2	3	-Y1	LVDS - Out	Camera Link Transmitter
	16	+Y1	LVDS - Out	Camera Link Transmitter
PAIR 3	4	-Y2	LVDS - Out	Camera Link Transmitter
	17	+Y2	LVDS - Out	Camera Link Transmitter
PAIR 4	5	-YCLK	LVDS - Out	Camera Link Transmitter
	18	+YCLK	LVDS - Out	Camera Link Clock Tx
PAIR 5	6	-Y3	LVDS - Out	Camera Link Channel Tx
	19	+Y3	LVDS - Out	Camera Link Channel Tx
PAIR 6	7	-	Not Used	Connected with 100 ohm
	20	-	Not Used	
PAIR 7	8	-Z0	LVDS - Out	Camera Link Transmitter
	21	+Z0	LVDS - Out	Camera Link Transmitter
PAIR 8	9	-Z1	LVDS - Out	Camera Link Transmitter
	22	+Z1	LVDS - Out	Camera Link Transmitter
PAIR 9	10	-Z2	LVDS - Out	Camera Link Transmitter
	23	+Z2	LVDS - Out	Camera Link Transmitter
PAIR 10	11	-ZCLK	LVDS - Out	Camera Link Transmitter
	24	+ZCLK	LVDS - Out	Camera Link Clock Tx
PAIR 11	12	-Z3	LVDS - Out	Camera Link Channel Tx
	25	+Z3	LVDS - Out	Camera Link Channel Tx
PAIR 12	13	Ground	Ground	Cable Shield
	26	Ground	Ground	Cable Shield

Table 7.2 Pin Assignments for Camera Link Connector 2

Model	Camera Link Tap Geometry	CL Configuration	CL Connector 1	CL Connector 2
VP-31MC	2 Tap	BASE	O	X
	4 Tap	MEDIUM	O	O
	8 Tap	FULL	O	O
	10 Tap	10 Tap	O	O

Table 7.3 Connector Arrangement for the Camera Link Tap Geometry



When you connect a CL frame grabber to the Camera Link connectors on the camera using Camera Link cables, make sure you connect the cables to their correct connectors. If you connect the Camera Link connector 1 on the camera to a connector other than connector 1 of the CL frame grabber, the camera may not transmit images correctly or the serial communication between the camera and the computer may fail.

7.3 Power Input Receptacle

The power input receptacle is a Hirose 6 pin connector (part # HR10A-7R-6PB). The pin assignments and configurations are as follows:

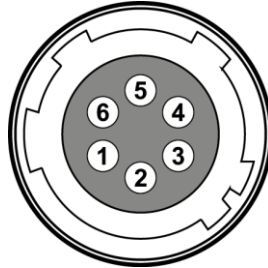

Figure 7.3 Pin Assignments for Power Input Receptacle

Pin Number	Signal	Type	Description
1, 2, 3	+12V DC	Input	DC Power Input
4, 5, 6	DC Ground	Input	DC Ground

Table 7.4 Pin Configuration for Power Input Receptacle



- A recommended mating connector for the Hirose 6 pin connector is the Hirose 6 pin plug (part # HR10A-7P-6S) or the equivalent.
- It is recommended that you use the power adapter, which has at least 5 A current output at 11 ~ 24 V voltage output (You need to purchase a power adapter separately.).

Precaution for Power Input



- Make sure the power is turned off before connecting the power cord to the camera. Otherwise, damage to the camera may result.
- If the voltage applied to the camera is greater than specified in the specifications, damage to the camera may result.

7.4 Control I/O Receptacle

The Control I/O Receptacle is a Hirose 4 pin connector (part # HR10A-7R-4S) and consists of an external trigger signal input and strobe output ports. The pin assignments and configurations are as follows:

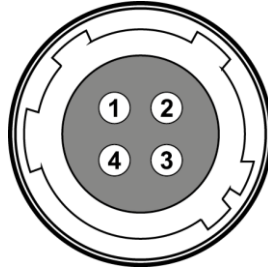

Figure 7.4 Pin Assignments for Control I/O Receptacle

Pin Number	Signal	Type	Description
1	Trigger Input +	Input	3.3 V ~ 24.0 V TTL input
2	Trigger Input -	Input	-
3	DC Ground	-	DC Ground
4	Line1 Output	Output	3.3 V TTL Output Output resistance: 47 Ω

Table 7.5 Pin Configurations for Control I/O Receptacle



A recommended mating connector for the Hirose 4 pin connector is the Hirose 4 pin plug (part # HR10A-7P-4P) or the equivalent.

7.5 Trigger Input Circuit

The following figure shows trigger signal input circuit of the 4 pin connector. Transmitted trigger signal is applied to the internal circuit through a photo coupler. With the Debounce feature, you can specify the width of input signal to be considered as a valid input signal. An external trigger circuit example is shown below.

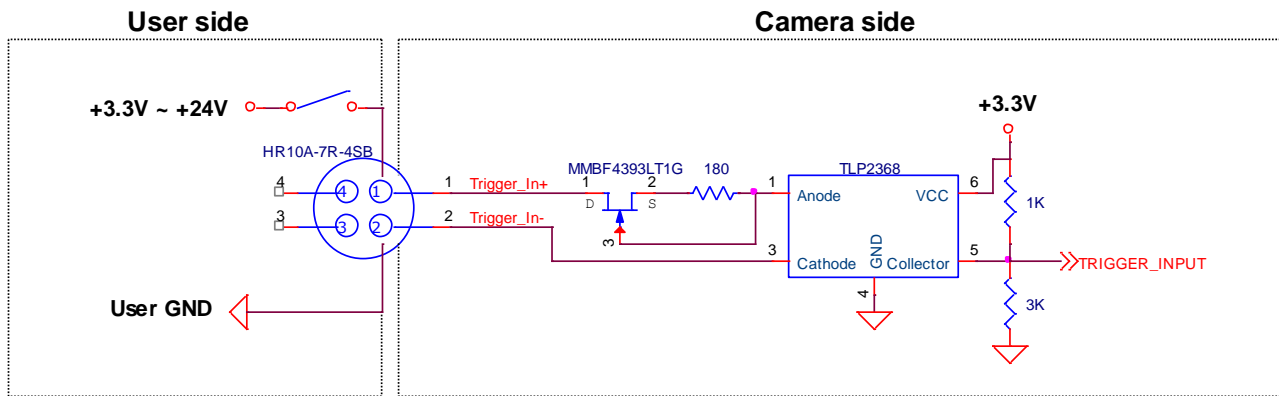

Figure 7.5 Trigger Input Schematic

7.6 Strobe Output Circuit

The strobe output signal comes out through a 3.3 V output level of TTL Driver IC. A pulse width of signal is synchronized with an exposure (shutter) signal of the camera.

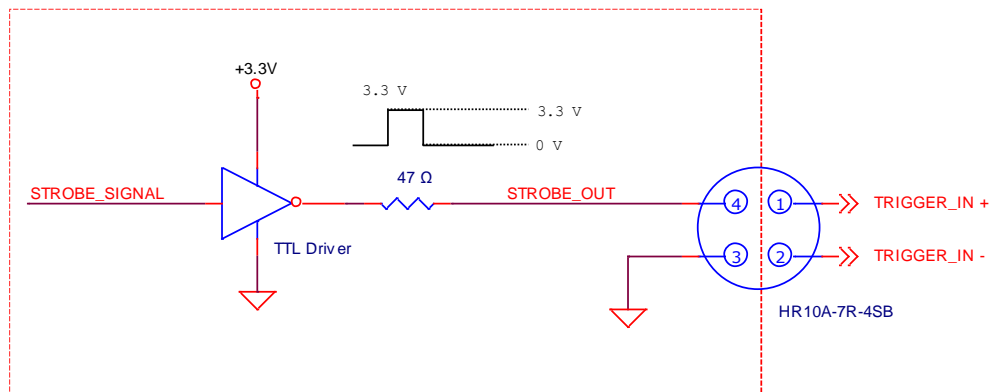

Figure 7.6 Strobe Output Schematic

8 Acquisition Control

This chapter provides detailed information about controlling image acquisition.

- Triggering image acquisition
- Setting the exposure time
- Controlling the camera's image acquisition rate
- Variation of the camera's maximum allowed image acquisition rate according to the camera settings

8.1 Overview

This section presents an overview of the elements involved with controlling the acquisition of images.

Three major elements are involved in controlling the acquisition of images:

- **Acquisition Start** and **Stop** commands and **Acquisition Mode** parameter
- Exposure start trigger
- Exposure time control



When reading the explanations in the overview and in this entire chapter, keep in mind that the term **frame** is typically used to mean a single acquired image.

Acquisition Start and Stop Commands and Acquisition Mode

The **Acquisition Start** command prepares the camera to acquire frames. The camera cannot acquire frames unless an **Acquisition Start** command has first been executed.

A parameter called the **Acquisition Mode** has a direct bearing on how the **Acquisition Start** command operates.

If the **Acquisition Mode** parameter is set to **Single Frame**, you can only acquire one frame after executing an **Acquisition Start** command. When one frame has been acquired, the **Acquisition Start** command will expire. Before attempting to acquire another frame, you must execute a new **Acquisition Start** command.

If the **Acquisition Mode** parameter is set to **Continuous**, an **Acquisition Start** command does not expire after a single frame is acquired. Once an **Acquisition Start** command has been executed, you can acquire as many frames as you like. The **Acquisition Start** command will remain in effect until you execute an **Acquisition Stop** command. Once an **Acquisition Stop** command has been executed, the camera will not be able to acquire frames until a new **Acquisition Start** command is executed.

Exposure Start Trigger

Applying an exposure start trigger signal to the camera will exit the camera from the *waiting for exposure start trigger* acquisition status and will begin the process of exposing and reading out a frame (see Figure 8.1).

As soon as the camera is ready to accept another exposure start trigger signal, it will return to the *waiting for exposure start trigger* acquisition status. A new exposure start trigger signal can then be applied to the camera to begin another frame exposure. The exposure start trigger has two modes: off and on.

If the **Trigger Mode** parameter is set to **Off**, the camera will generate all required exposure start trigger signals internally, and you do not need to apply exposure start trigger signals to the camera. The rate at which the camera will generate the signals and acquire frames will be determined by the way that you set several frame rate related parameters.

If the **Trigger Mode** parameter is set to **On**, you must trigger exposure start by applying exposure start trigger signals to the camera. Each time a trigger signal is applied, the camera will begin a frame exposure. When exposure start is being triggered in this manner, it is important that you do not attempt to trigger frames at a rate that is greater than the maximum allowed (There is a detailed explanation about the maximum allowed frame rate at the end of this chapter.). Exposure start trigger signals applied to the camera when it is not in a *waiting for exposure start trigger* acquisition status will be ignored.

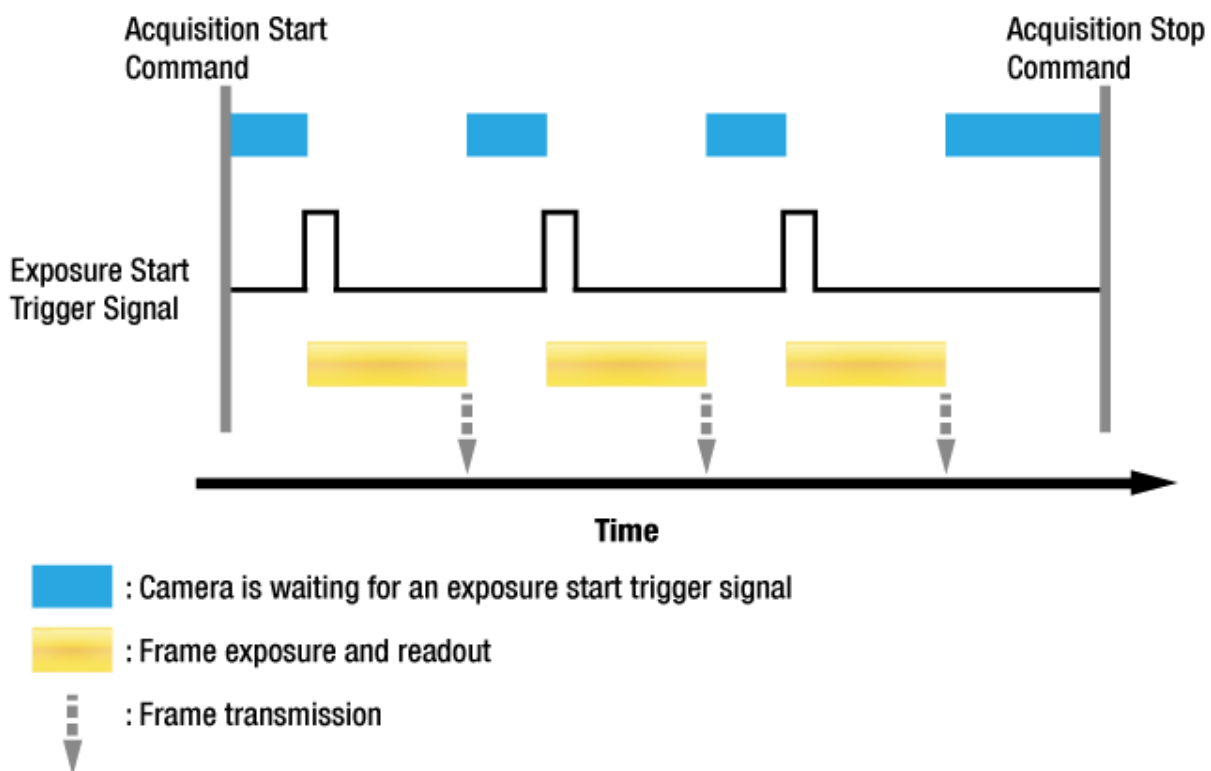

Figure 8.1 Exposure Start Triggering

Applying Trigger Signals

The paragraphs above mention “applying a trigger signal”. There are five ways to apply an exposure start trigger signal to the camera: via **Software**, via **User Output0**, via **CC1**, via **Timer0 Active** or via **Line0** (commonly referred to as hardware).

- To apply trigger signals via **Software**, you must set the **Trigger Source** parameter to **Software**. At that point, each time a **Trigger Software** command is executed, the exposure start trigger signal will be applied to the camera.
- To apply trigger signals via **User Output0**, you must set the **Trigger Source** parameter to **User Output0**. At that point, you can apply an exposure start trigger signal to the camera by switching the **User Output Value** parameter between **On** (rise) and **Off** (fall).
- To apply trigger signals via CL frame grabber, you must set the **Trigger Source** parameter to **CC1**. At that point, each time an externally generated electrical signal is applied to the camera by using the APIs provided by a CL frame grabber manufacturer, the exposure start trigger signal will be applied to the camera. For more information, refer to your CL frame grabber user manual.
- To apply trigger signals via the user-defined Timer feature, you must set the **Trigger Source** parameter to **Timer0 Active**. When you set the **Timer Trigger Source** parameter to **Line0** in the **Counter And Timer Control** category, you can apply an exposure start trigger signal to the camera by using a Timer that uses the Line0 signal as the source signal.
- To apply trigger signals via hardware (external), you must set the **Trigger Source** parameter to **Line0**. At that point, each time a proper electrical signal is applied to the camera, an occurrence of the exposure start trigger signal will be recognized by the camera.

Exposure Time Control

When an exposure start trigger signal is applied to the camera, the camera will begin to acquire a frame.

A critical aspect of frame acquisition is how long the pixels in the camera’s sensor will be exposed to light during the frame acquisition.

If the **Trigger Source** parameter is set to **Software**, the **Exposure Time** parameter will determine the exposure time for each frame.

If the **Trigger Source** parameter is set to **User Output0**, **CC1**, **Timer0 Active** or **Line0**, there are two modes of operation: **Timed** and **Trigger Width**.

With the **Timed** mode, the **Exposure Time** parameter will determine the exposure time for each frame.

With the **Trigger Width** mode, the way that you manipulate the rise and fall of the User Output, CC1, Timer or hardware (external) signal will determine the exposure time. The **Trigger Width** mode is especially useful if you want to change the exposure time from frame to frame.

8.2 Acquisition Start/Stop Commands and Acquisition Mode

Executing an **Acquisition Start** command prepares the camera to acquire frames. You must execute an **Acquisition Start** command before you can begin acquiring frames. Executing an **Acquisition Stop** command terminates the camera's ability to acquire frames. When the camera receives an **Acquisition Stop** command:

- If the camera is not in the process of acquiring a frame, its ability to acquire frames will be terminated immediately.
- If the camera is in the process of acquiring a frame, the frame acquisition process will be allowed to finish and the camera's ability to acquire new frames will be terminated.

The **Acquisition Status** parameter allows you to check whether the camera is in the process of acquiring a frame or not. When you read the **Acquisition Status** parameter while the camera is in the process of acquiring a frame, it will return True or the check box will be selected. When you read the **Acquisition Status** parameter while the camera is not in the process of acquiring a frame, it will return False or the check box will not be selected.



When you execute the **Acquisition Start** command while the previous frame acquisition process is still in progress, the command will be ignored. To avoid this, you must wait until the camera completes the frame acquisition process after the execution of the **Acquisition Stop** command. Then, you can safely execute the **Acquisition Start** command again.

The camera's **Acquisition Mode** parameter has three settings: **Single Frame**, **Multi-Frame** and **Continuous**. The use of **Acquisition Start** and **Acquisition Stop** commands and the camera's **Acquisition Mode** parameter setting are related.

If the camera's **Acquisition Mode** parameter is set to **Single Frame**, after an **Acquisition Start** command has been executed, a single frame can be acquired. When acquisition of one frame is complete, the camera will execute an **Acquisition Stop** command internally and will no longer be able to acquire frames. To acquire another frame, you must execute a new **Acquisition Start** command.

If the camera's **Acquisition Mode** parameter is set to **Multi-Frame**, after an **Acquisition Start** command has been executed, exposure start can be triggered as many as specified by the **Acquisition Frame Count** parameter. The camera will continue to react to exposure start trigger signals until the number of exposure start trigger signals it has received is equal to the current **Acquisition Frame Count** parameter setting. At that point, the **Acquisition Start** command will expire. Before attempting to acquire another frame, you must execute a new **Acquisition Start** command.

If the camera's **Acquisition Mode** parameter is set to **Continuous**, after an **Acquisition Start** command has been executed, exposure start can be triggered as desired. Each time an exposure start trigger is applied while the camera is in a *waiting for exposure start trigger* acquisition status, the camera will acquire and transmit a frame. The camera will retain the ability to acquire frames until an **Acquisition Stop** command is executed. Once the **Acquisition Stop** command is received, the camera will no longer be able to acquire frames.

8.3 Exposure Start Trigger

The exposure start trigger is used to begin frame acquisition. Exposure start trigger signals can be generated within the camera or may be applied externally by setting the **Trigger Source** parameter to **Software**, **User Output0**, **CC1**, **Timer0 Active** or **Line0**. If an exposure start trigger signal is applied to the camera, the camera will begin to expose a frame.

8.3.1 Trigger Mode

The main parameter associated with the exposure start trigger is the **Trigger Mode** parameter.

The **Trigger Mode** parameter for the exposure start trigger has two available settings: **Off** and **On**.



You cannot change the **Trigger Mode** parameter after executing the **Acquisition Start** command. Change the **Trigger Mode** parameter after executing the **Acquisition Stop** command.

8.3.1.1 Trigger Mode = Off

When the **Trigger Mode** parameter is set to **Off**, the camera will generate all required exposure start trigger signals internally, and you do not need to apply exposure start trigger signals to the camera.

With the **Trigger Mode** set to **Off**, the way that the camera will operate the exposure start trigger depends on the setting of the camera's **Acquisition Mode** parameter:

- **Single Frame:** The camera will automatically generate a single exposure start trigger signal whenever it receives an **Acquisition Start** command.
- **Multi-Frame:** The camera will automatically begin generating exposure start trigger signals as many as specified by the **Acquisition Frame Count** parameter when it receives an **Acquisition Start** command. The camera will continue to generate exposure start trigger signals until the number of exposure start trigger signals it has received is equal to the current **Acquisition Frame Count** parameter setting or until it receives an **Acquisition Stop** command.



When the **Acquisition Mode** parameter is set to **Multi-Frame**, you must set the value of the camera's **Acquisition Frame Count** parameter. The value of the **Acquisition Frame Count** can range from 1 to 255.

- **Continuous:** The camera will automatically begin generating exposure start trigger signals when it receives an **Acquisition Start** command. The camera will continue to generate exposure start trigger signals until it receives an **Acquisition Stop** command.



Free Run

When you set the **Trigger Mode** parameter to **Off** and the **Acquisition Mode** parameter to **Continuous**, the camera will generate all required trigger signals internally. When the camera is set this way, it will constantly acquire images without any need for triggering by the user. This use case is commonly referred to as “free run”.

The rate at which the exposure start trigger signals are generated may be determined by the camera's **Acquisition Frame Rate** parameter.

- If the parameter is set to a value less than the maximum allowed frame rate with the current camera settings, the camera will generate exposure start trigger signals at the rate specified by the parameter setting.
- If the parameter is set to a value greater than the maximum allowed frame rate with the current camera settings, the camera will generate exposure start trigger signals at the maximum allowed frame rate.

Exposure Time Control with Trigger Mode = Off

When the **Trigger Mode** parameter is set to **Off**, the exposure time for each frame acquisition is determined by the value of the camera's **Exposure Time** parameter. For more information, see [8.4 Setting the Exposure Time](#).

8.3.1.2 Trigger Mode = On

When the **Trigger Mode** parameter is set to **On**, you must apply an exposure start trigger signal to the camera each time you want to begin a frame acquisition. The **Trigger Source** parameter specifies the source signal that will act as the exposure start trigger signal.

The available settings for the **Trigger Source** parameter are:

- **Software:** You can apply an exposure start trigger signal to the camera by executing the **Trigger Software** command for the exposure start trigger on your computer.
- **User Output0:** You can apply an exposure start trigger signal to the camera by switching the **User Output Value** parameter between **On** and **Off** on your computer.
- **CC1:** You can apply an exposure start trigger signal to the camera via CC1 in the Camera Link interface. For more information, refer to your Camera Link frame grabber user manual.
- **Timer0Active:** You can apply an exposure start trigger signal to the camera using a user-defined Timer signal. When you set the **Timer Trigger Source** parameter to **Line0** in the **Counter And Timer Control** category, you can specify a delay for the Line0 signal by using the **Timer Delay** parameter. For more information, refer to [9.15 Timer Control](#).
- **Line0:** You can apply an exposure start trigger signal to the camera by injecting an externally generated electrical signal (commonly referred to as a hardware or external trigger signal) into the Control I/O receptacle on the camera. Refer to [7.5 Trigger Input Circuit](#) for more information.

You must also set the **Trigger Activation** parameter after setting the **Trigger Source** parameter.

The available settings for the **Trigger Activation** parameter are:

- **Falling Edge:** Specifies that a falling edge of the electrical signal will act as the exposure start trigger.
- **Rising Edge:** Specifies that a rising edge of the electrical signal will act as the exposure start trigger.

Exposure Time Control with Trigger Mode = On

When the **Trigger Mode** parameter is set to **On** and the **Trigger Source** parameter is set to **Software**, the exposure time for each frame acquisition is determined by the value of the camera's **Exposure Time** parameter.

When the **Trigger Mode** parameter is set to **On** and the **Trigger Source** parameter is set to **CC1** or **Line0**, the exposure time for each frame acquisition will be determined by the **Exposure Mode** parameter settings as follows:

- **Exposure Mode = Timed:** Exposure time can be controlled with the **Exposure Time** parameter.
- **Exposure Mode = Trigger Width:** Exposure time can be controlled by manipulating the external trigger signal.

When the **Trigger Mode** parameter is set to **On** and the **Trigger Source** parameter is set to **Timer0 Active**, the exposure time for each frame acquisition will be determined by the **Exposure Mode** parameter settings as follows:

- **Exposure Mode = Timed:** Exposure time can be controlled with the **Exposure Time** parameter.
- **Exposure Mode = Trigger Width:** When you set the **Timer Trigger Activation** parameter to **Rising/Falling Edge**, the exposure time is controlled with the **Timer Duration** parameter. When you set the **Timer Trigger Activation** parameter to **Level High/Low**, the exposure time can be controlled by manipulating the external trigger signal.

When the **Trigger Mode** parameter is set to **On** and the **Trigger Source** parameter is set to **User Output0**, the exposure time for each frame acquisition will be determined by the **Exposure Mode** parameter settings as follows:

- **Exposure Mode = Timed:** Exposure time can be controlled with the **Exposure Time** parameter.
- **Exposure Mode = Trigger Width:** Exposure time can be controlled by switching the **User Output Value** parameter between **On** and **Off**.

8.3.2 Using a Software Trigger Signal

If the **Trigger Mode** parameter is set to **On** and the **Trigger Source** parameter is set to **Software**, you must apply a software trigger signal (exposure start) to the camera to begin each frame acquisition. Assuming that the camera is in a *waiting for exposure start trigger* acquisition status, frame exposure will start when the software trigger signal is received by the camera. Figure 8.2 illustrates frame acquisition with a software trigger signal. When the camera receives a software trigger signal and begins exposure, it will exit the *waiting for exposure start trigger* acquisition status because at that point, it cannot react to a new exposure start trigger signal. As soon as the camera is capable of reacting to a new exposure start trigger signal, it will automatically return to the *waiting for exposure start trigger* acquisition status.

The exposure time for each acquired frame will be determined by the value of the camera's **Exposure Time** parameter.

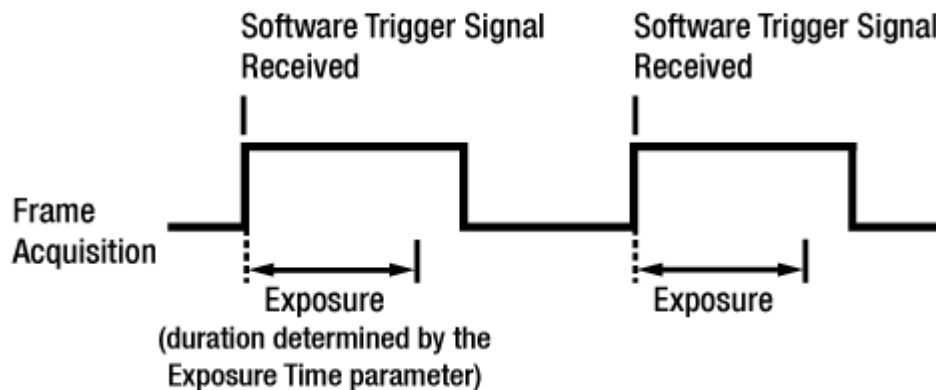

Figure 8.2 Frame Acquisition with Software Trigger Signal

When you are using a software trigger signal to start each frame acquisition, the frame rate will be determined by how often you apply a software trigger signal to the camera, and you should not attempt to trigger frame acquisition at a rate that exceeds the maximum allowed for the current camera settings (There is a detailed explanation about the maximum allowed frame rate at the end of this chapter.). Software trigger signals that are applied to the camera when it is not ready to receive them will be ignored.

8.3.3 Using a CC1 Trigger Signal

If the **Trigger Mode** parameter is set to **On** and the **Trigger Source** parameter is set to **CC1**, you must apply a CC1 trigger signal to the camera to begin each frame acquisition. A CC1 trigger signal will act as the exposure start trigger signal for the camera. For more information, refer to your Camera Link frame grabber user manual. A rising edge or falling edge of the CC1 signal can be used to trigger frame acquisition. The **Trigger Activation** parameter is used to select rising edge or falling edge triggering.

Assuming that the camera is in a *waiting for exposure start trigger* acquisition status, frame acquisition will start whenever the appropriate edge transition is received by the camera.

When the camera receives a CC1 trigger signal and begins exposure, it will exit the *waiting for exposure start trigger* acquisition status because at that point, it cannot react to a new exposure start trigger signal.

As soon as the camera is capable of reacting to a new exposure start trigger signal, it will automatically return to the *waiting for exposure start trigger* acquisition status.

When the camera is operating under control of a CC1 signal, the period of the CC1 trigger signal will determine the rate at which the camera is acquiring frames:

$$\frac{1}{\text{CC1 signal period in seconds}} = \text{Frame Rate}$$

For example, if you are operating a camera with a CC1 trigger signal period of 50 ms (0.05 s):

So in this case, the frame rate is 20 fps.

8.3.4 Using an External Trigger Signal

If the **Trigger Mode** parameter is set to **On** and the **Trigger Source** parameter is set to **Line0**, an externally generated electrical signal injected into the Control I/O Receptacle will act as the exposure start trigger signal for the camera. This type of trigger signal is generally referred to as a hardware trigger signal.

A rising edge or a falling edge of the external signal can be used to trigger frame acquisition. The **Trigger Activation** parameter is used to select rising edge or falling edge triggering.

Assuming that the camera is in a *waiting for exposure start trigger* acquisition status, frame acquisition will start whenever the appropriate edge transition is received by the camera.

When the camera receives an external trigger signal and begins exposure, it will exit the *waiting for exposure start trigger* acquisition status because at that point, it cannot react to a new exposure start trigger signal.

As soon as the camera is capable of reacting to a new exposure start trigger signal, it will automatically return to the *waiting for exposure start trigger* acquisition status.

When the camera is operating under control of an external signal, the period of the external trigger signal will determine the rate at which the camera is acquiring frames:

$$\frac{1}{\text{External signal period in seconds}} = \text{Frame Rate}$$

For example, if you are operating a camera with an external trigger signal period of 50 ms (0.05 s):

So in this case, the frame rate is 20 fps.

8.3.4.1 External Trigger Delay

When you set the **Trigger Source** parameter to **Timer0Active**, you can specify a delay between the receipt of a hardware trigger signal and when the trigger becomes effective.

1. Set the **Timer Trigger Source** parameter in the **Counter And Timer Control** category to **Line0**.
2. Set a delay (in microseconds) by using the **Timer Delay** parameter.
3. Set the **Trigger Source** parameter in the **Acquisition Control** category to **Timer0Active**.
4. Execute the **Acquisition Start** command and inject an externally generated electrical signal into the Control I/O Receptacle. Then, the delay set by the **Timer Delay** parameter expires and the exposure for image acquisition begins.

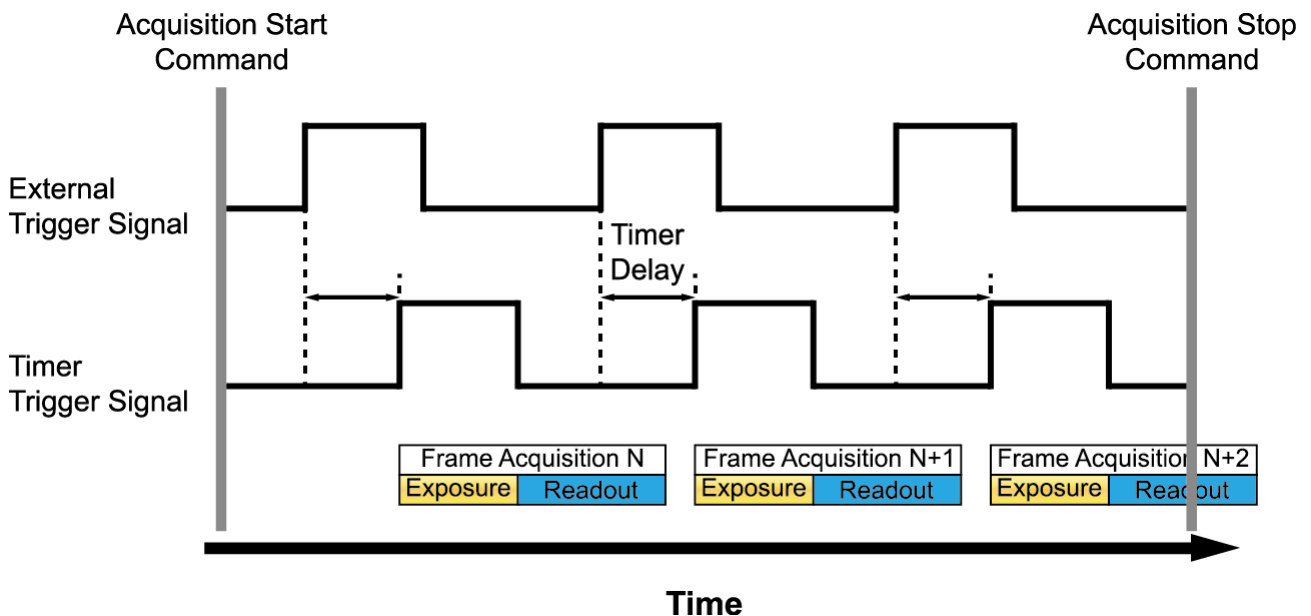

Figure 8.3 External Trigger Delay

8.3.5 Exposure Mode

If you are triggering the start of frame acquisition with an externally generated trigger signal (CC1 or External), two exposure modes are available: **Timed** and **Trigger Width**.

Timed Exposure Mode

When the **Timed** mode is selected, the exposure time for each frame acquisition is determined by the value of the camera's **Exposure Time** parameter. If the camera is set for rising edge triggering, the exposure time starts when the external trigger signal rises. If the camera is set for falling edge triggering, the exposure time starts when the external trigger signal falls. The following figure illustrates **Timed** exposure with the camera set for rising edge triggering.

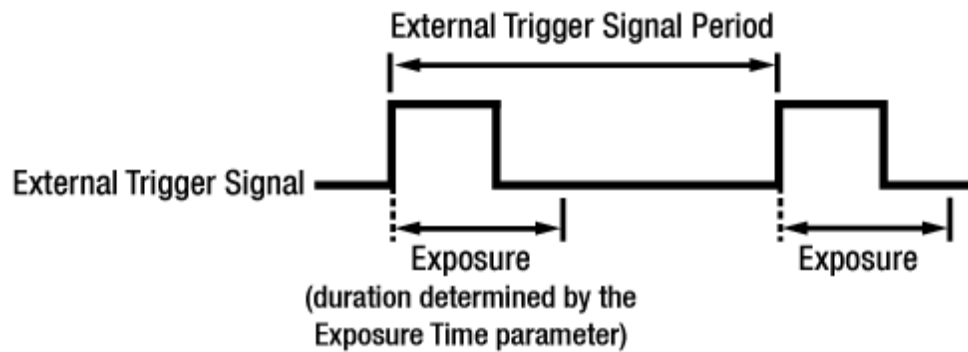

Figure 8.4 Timed Exposure Mode

Note that if you attempt to trigger a new exposure start while the previous exposure is still in progress, the trigger signal will be ignored.

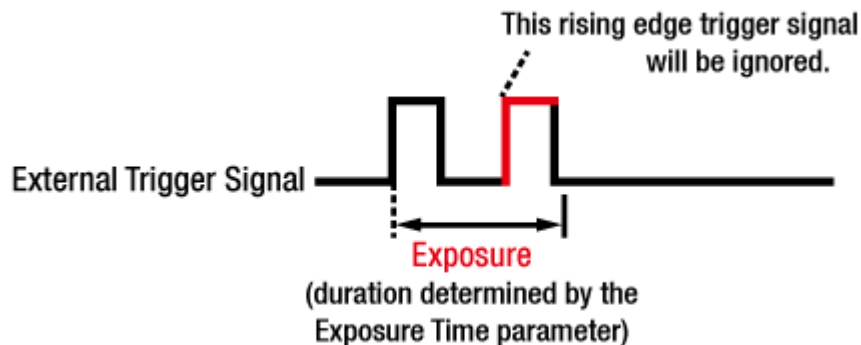

Figure 8.5 Trigger Overlapped with Timed Exposure Mode

Trigger Width Exposure Mode

When the **Trigger Width** exposure mode is selected, the length of the exposure for each frame acquisition will be directly controlled by the external trigger signal (CC1 or External). If the camera is set for rising edge triggering, the exposure time begins when the external trigger signal rises and continues until the external trigger signal falls. If the camera is set for falling edge triggering, the exposure time begins when the external trigger signal falls and continues until the external trigger signal rises. The following figure illustrates **Trigger Width** exposure with the camera set for rising edge triggering.

Trigger Width exposure is especially useful if you intend to vary the length of the exposure time for each frame.

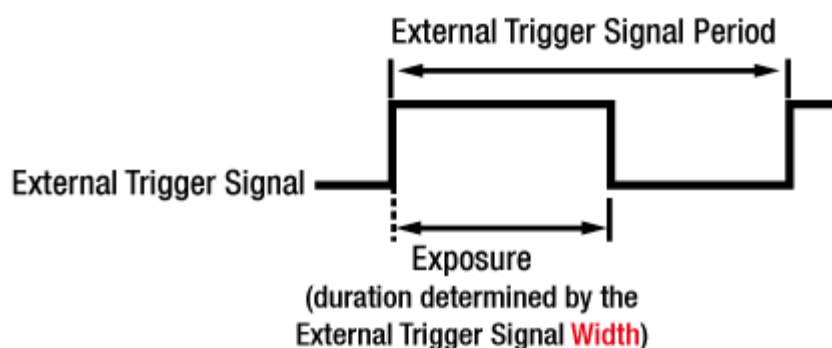

Figure 8.6 Trigger Width Exposure Mode

8.3.6 Short Exposure Mode

The VP-31MC-26 H camera provides the **Short Exposure Mode** which allows you to set a shorter exposure time than the normal Exposure Mode. The available setting range of the exposure time (refer to [Table 8.2 Minimum and Maximum Exposure Time Setting](#)) and the Exposure Offset values ([Table 8.1 Exposure Offset](#)) vary depending on the **Short Exposure Mode** setting.

- **Short Exposure Mode = Off:** Enables the normal Exposure Mode.
- **Short Exposure Mode = Super Short:** Allows you to set a shorter exposure time by adding a shorter Exposure Offset to the exposure time than the normal Exposure Mode.
- **Short Exposure Mode = Ultra Short:** Allows you to set the shortest exposure time by adding the shortest Exposure Offset to the exposure time.



Exposure Mode

- When you set the **Short Exposure Mode** parameter to **Off** or **Super Short**, both the **Timed** and **Trigger Width** exposure mode are available. However, with the **Short Exposure Mode** set to **Ultra Short**, the **Timed** exposure mode is only available.

Short Exposure Mode = Super Short

- Acquiring frames at a rate lower than the maximum allowed frame rate with the **Short Exposure Mode** parameter set to **Super Short** may result in an offset to the pixel values output by the camera.

8.3.7 Exposure Offset

The VP-31MC-26 H camera adds an **Exposure Offset** automatically to the exposure time determined by the **Exposure Time** parameter or the width of the external trigger signal.

To acquire an image with the desired exposure time, you must compensate for the Exposure Offset as follows.

1. Subtract the **Exposure Offset** from the desired exposure time.
2. Set the **Exposure Time** parameter with the resulting time or use the resulting time as the high or low time for the external trigger signal.

Short Exposure Mode	Exposure Offset
Off (Normal Exposure Mode)	30.06 μ s
Super Short	2.80 μ s
Ultra Short	0.03 μ s

Table 8.1 Exposure Offset

For example, if you want to set an exposure time to about 300 μ s, set the Exposure Time parameter to 270 μ s (300 – 30.06 = 269.94 \approx 270) or use 270 μ s as the high or low time for the external trigger signal.

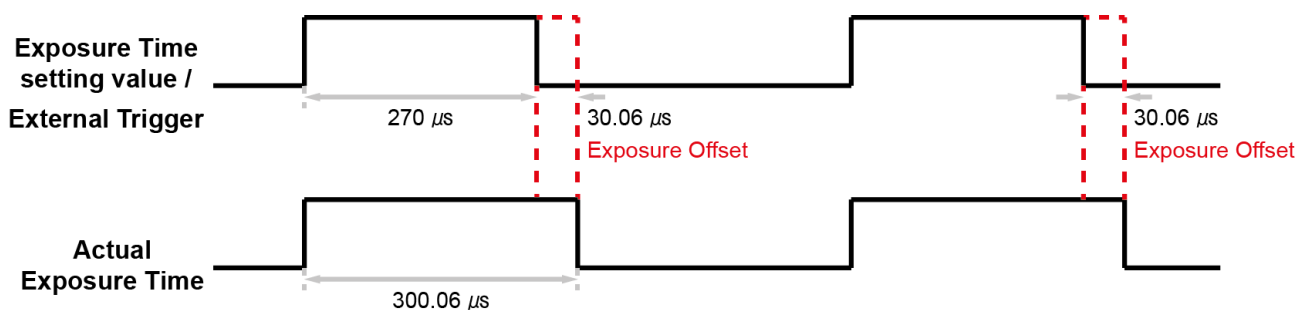

Figure 8.7 Setting Exposure Time to compensate for the Exposure Offset

8.4 Setting the Exposure Time

This section describes how the exposure time can be adjusted manually by setting the value of the **Exposure Time** parameter. If you are operating the camera in any one of the following ways, you must specify an exposure time by setting the camera's **Exposure Time** parameter.

- the **Trigger Mode** is set to **Off**.
- the **Trigger Mode** is set to **On** and the **Trigger Source** is set to **Software**.
- the **Trigger Mode** is set to **On**, the **Trigger Source** is set to **User Output0**, **CC1**, **Timer0 Active** or **Line0**, and the **Exposure Mode** is set to **Timed**.

The VP-31MC-26 H camera adds an **Exposure Offset** (refer to [Table 8.1 Exposure Offset](#)) automatically to the exposure time determined by the **Exposure Time** parameter. The **Exposure Time** parameter sets the exposure time in microseconds (μs). The minimum and maximum exposure time settings for the camera are shown in the following table.

Short Exposure Mode	Minimum Exposure Time	Maximum Exposure Time
Off (Normal Exposure Mode)	7.84 μs	60,000,000 μs [†]
Super Short	7.84 μs	60,000,000 μs [†]
Ultra Short	2.37 μs	32.27 μs

[†]: When the **Exposure Mode** is set to **Trigger Width**, the exposure time is controlled by the external trigger signal and has no maximum limit.

Table 8.2 Minimum and Maximum Exposure Time Setting

8.5 Overlapping Exposure with Sensor Readout

The frame acquisition process on the camera includes two distinct parts. The first part is the exposure of the pixels in the image sensor. Once exposure is complete, the second part of the process – readout of the pixel values from the sensor – takes place. In regard to this frame acquisition process, the VP-31MC-26 H camera basically operates with ‘overlapped’ exposure so that the exposure for a new frame can be overlapped with the sensor readout for the previous frame.

When a new trigger signal is applied to the camera while reading out the previous frame, the camera begins the process of exposing a new frame. This situation is illustrated in the following figure with the **Trigger Mode** set to **On**, the **Trigger Source** set to **Line0** and the **Exposure Mode** set to **Trigger Width**.

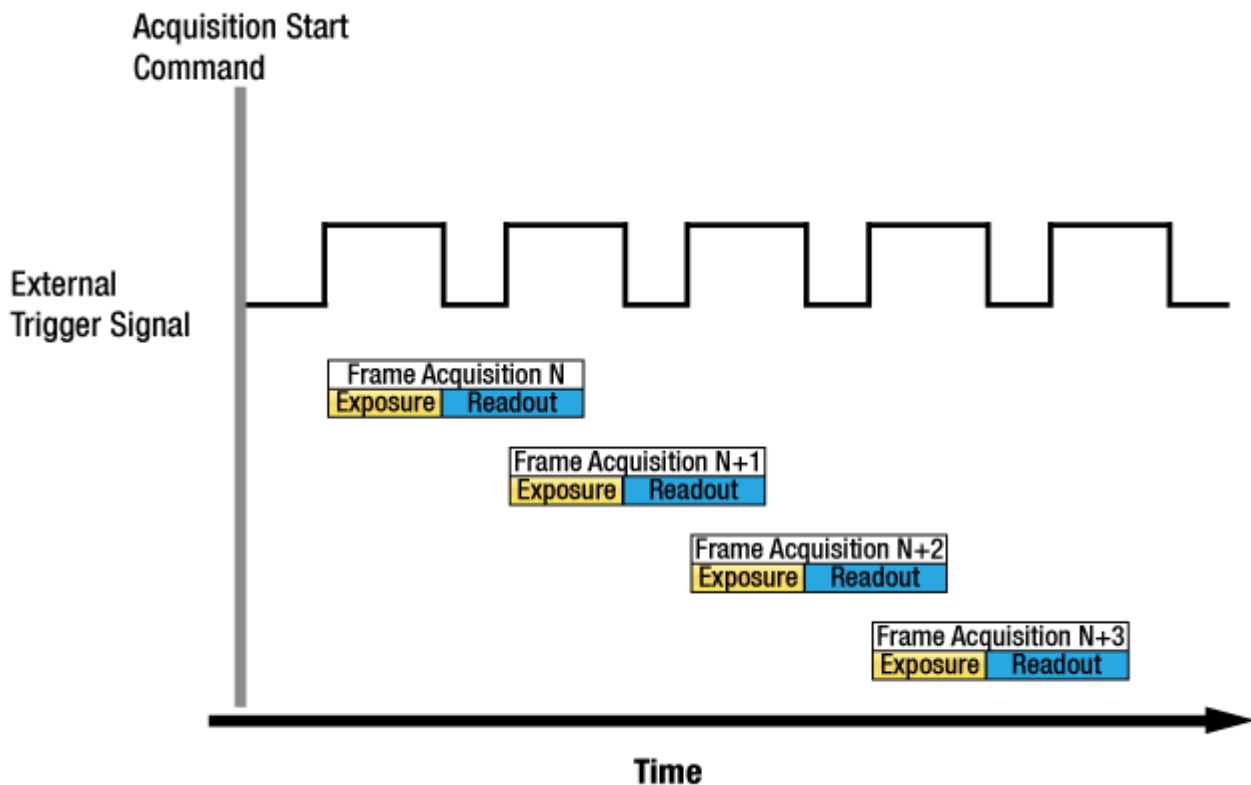

Figure 8.8 Overlapped Exposure and Readout

Determining whether your camera is operating with overlapped exposure and readout is not a matter of issuing a command or changing a setting. Rather a way that you operate the camera will determine whether the exposures and readouts are overlapped or not. If we define the “Frame Period” as the time from the start of exposure for one frame acquisition to the start of exposure for the next frame acquisition, then:

- Overlapped: $\text{Frame Period} \leq \text{Exposure Time} + \text{Readout Time}$

Guidelines for Overlapped Exposure

Since the VP-31MC-26 H camera operates with overlapped exposure, you must keep in mind two important guidelines:

- You must not begin the exposure for a new frame while the exposure for the previous frame is in progress.
- You must not end the exposure for the current frame until the readout for the previous frame is complete.

When you are operating the camera with overlapped exposure and using an external trigger signal to trigger image acquisition, you could use the camera's Exposure Time parameter settings and timing formula to calculate when it is safe to begin each new acquisition.

8.6 Global Shutter

The VP-31MC-26 H camera is equipped with an image sensor that has an electronic shutter. When an exposure start trigger signal is applied to the camera equipped with a global shutter, exposure begins for all lines in the sensor as shown in the figure below. Exposure continues for all lines in the sensor until the programmed exposure time ends or when the exposure start trigger signal ends the exposure time if the camera is using the trigger width exposure mode. At the end of the exposure time, exposure ends for all lines in the sensor.

Immediately after the end of exposure, pixel data readout begins and proceeds line by line until all pixel data is read out of the sensor. A main characteristic of a global shutter is that for each frame acquisition, all of the pixels in the sensor start exposing at the same time and all end exposing at the same time. This means that image brightness tends to be more uniform over the entire area of each acquired image, and it helps to minimize problems with acquiring images of object in motion.

The camera can provide an **Exposure Active** output signal that will go high when the exposure time for a frame acquisition begins and will go low when the exposure time ends.

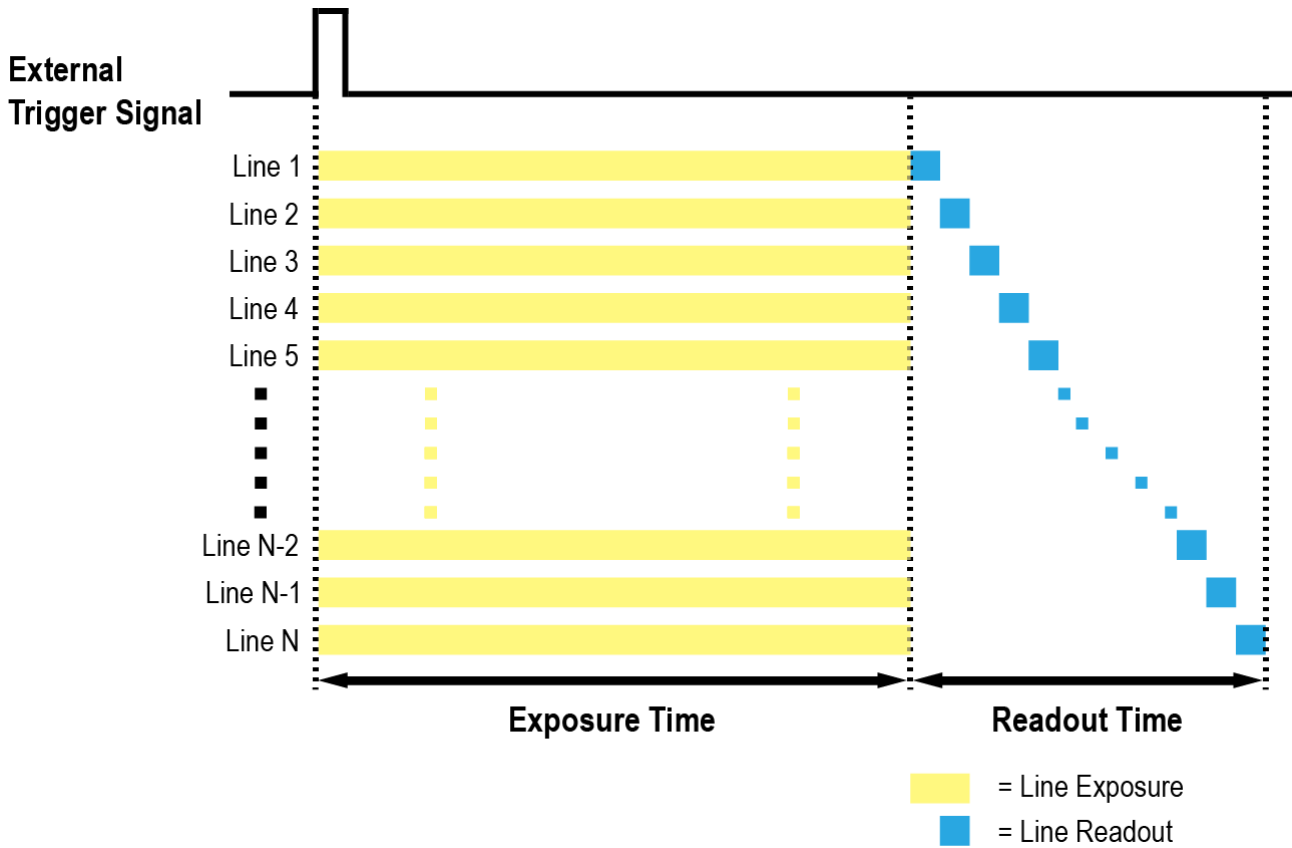

Figure 8.9 Global Shutter

8.7 Maximum Allowed Frame Rate

In general, the maximum allowed acquisition frame rate on the camera may be limited by several factors:

- The amount of time that it takes to transmit an acquired frame from the camera to your computer.
The amount of time needed to transmit a frame depends on the bandwidth assigned to the camera.
- The amount of time it takes to read an acquired frame out of the image sensor and into the camera's frame buffer. This time varies depending on the setting for ROI. Frames with a smaller height and/or width take less time to read out of the sensor. The frame height and width are determined by the camera's **Height** and **Width** settings in the **Image Format Control**.
- The Camera Link Tap Geometry. When the camera is set for a Camera Link Tap Geometry that uses more taps, it can typically transfer data out of the camera faster than when it is set for a Camera Link Tap Geometry that uses less taps.
- The exposure time for acquired frames. If you use very long exposure time, you can acquire fewer frames per second.

8.7.1 Increasing the Maximum Allowed Frame Rate

You may find that you would like to acquire frames at a rate higher than the maximum allowed with the camera's current settings. In this case, you must adjust one or more of the factors that can influence the maximum allowed frame rate and then check to see if the maximum allowed frame rate has increased.

- The time that it takes to transmit a frame out of the camera is the main limiting factor on the frame rate. You can decrease the frame transmission time (and thus increase the maximum allowed frame rate) by using the ROI feature.
 - Decreasing the size of the Image ROI may increase the maximum allowed frame rate. If possible, decrease the height and/or width of the Image ROI.
- If you have set the Camera Link Pixel Clock speed to a low value, consider setting it to a higher value. Before setting the camera's Pixel Clock to a higher value, make sure that your frame grabber is compatible with the higher Pixel Clock speed.
- If you are using a Camera Link Tap Geometry with a low number of taps, consider using a Camera Link Tap Geometry with a high number of taps. This will usually increase the maximum allowed frame rate.
- If you are using normal exposure times and you are using the camera at its maximum resolution, your exposure time will not normally restrict the frame rate. However, if you are using long exposure times, it is possible that your exposure time is limiting the maximum allowed frame rate. If you are using a long exposure time, try using a shorter exposure time and see if the maximum allowed frame rate increases (You may need to compensate for a lower exposure time by using a brighter light source or increasing the opening of your lens aperture.).



A very long exposure time severely limits the camera's maximum allowed frame rate.

As an example, assume that your camera is set to use a 1 second exposure time. In this case, because each frame acquisition will take at least 1 second to be completed, the camera will only be able to acquire a maximum of one frame per second.

9 Camera Features

9.1 Image Region of Interest

The Image Region of Interest (ROI) feature allows you to specify a portion of the sensor array. You can acquire only the frame data from the specified portion of the sensor array while preserving the same quality as you acquire a frame from the entire sensor array.

With the ROI feature, you can increase the maximum allowed frame rate by decreasing the **Width** and/or **Height** parameters. The ROI is referenced to the top left corner [origin (0, 0)] of the sensor array as shown below.

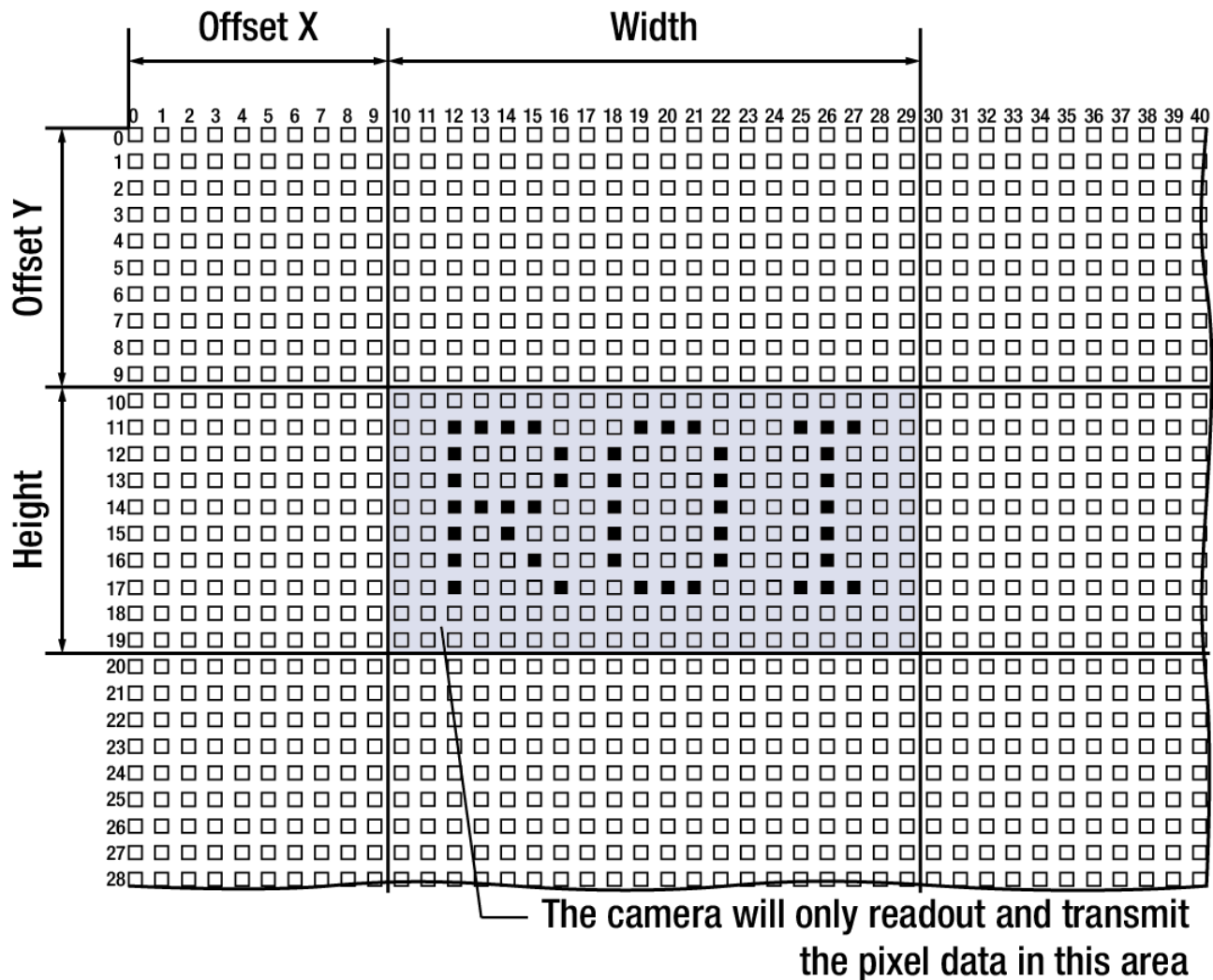

Figure 9.1 Region of Interest

The XML parameters related to ROI are as follows.

XML Parameters	Value	Description	
ImageFormatControl	SensorWidth ^a	-	Effective width of the sensor
	SensorHeight ^a	-	Effective height of the sensor
	WidthMax	-	Maximum allowed width of the image with the current camera settings
	HeightMax	-	Maximum allowed height of the image with the current camera settings
	Width ^b	-	Sets the Width of the Image ROI.
	Height ^b	-	Sets the Height of the Image ROI.
	OffsetX ^c	-	Sets the horizontal offset from the origin to the Image ROI.
	OffsetY ^c	-	Sets the vertical offset from the origin to the Image ROI.

The unit for all parameters in this table is pixel.

a: Read only. User cannot change the value.

b: User configurable parameters for setting ROI

c: User configurable parameters for setting the origin of the ROI

Table 9.1 XML Parameters related to ROI

You can change the size of ROI by setting the **Width** and **Height** parameters in the **Image Format Control** category. You can also change the position of the ROI origin by setting the **Offset X** and **Offset Y** parameters. Make sure that the **Width + Offset X** value is less than the **Width Max** value, and the **Height + Offset Y** value is less than the **Height Max** value. You must set the size of the ROI first, and then set the Offset values since the **Width** and **Height** parameters are set to its maximum value by default.

- On the VP-31MC-26 H camera, the **Width** parameter must be set to a multiple of 16, and the **Height** parameter must be set to a multiple of 4.

The minimum allowed setting values for the ROI Width and Height are shown below.

Minimum Width	Minimum Height
16	4

Table 9.2 Minimum ROI Width and Height Settings



When you change the Image ROI settings after executing the **Acquisition Start** command, the camera may acquire abnormal images. Change the Image ROI settings after executing the **Acquisition Stop** command.

On the VP-31MC-26 H camera, the maximum allowed frame rates depending on Horizontal and Vertical ROI changes are shown below.

ROI Size (H × V)	2 Tap	4 Tap	8 Tap	10 Tap
6464 × 4	354.4 fps	707.1 fps	1157.0 fps	1442.3 fps
6464 × 1000	24.5 fps	48.9 fps	95.8 fps	119.5 fps
6464 × 2000	12.6 fps	25.2 fps	49.9 fps	62.2 fps
6464 × 3000	8.5 fps	17.0 fps	33.7 fps	42.0 fps
6464 × 4000	6.4 fps	12.8 fps	25.4 fps	31.7 fps
1312 × 4852	25.9 fps	25.9 fps	25.9 fps	25.9 fps
2624 × 4852	13.0 fps	25.9 fps	25.9 fps	25.9 fps
5264 × 4852	6.5 fps	13.0 fps	25.9 fps	25.9 fps
6464 × 4852	5.3 fps	10.6 fps	21.0 fps	26.2 fps

Table 9.3 Maximum Frame Rates by VP-31MC-26 H ROI Changes (@ Camera Link Pixel Clock 85MHz)



Your Camera Link frame grabber may place additional restrictions on how the ROI location and size must be set. Refer to your frame grabber user manual for more information.

9.2 Multi-ROI

The VP-31MC-26 H camera provides the Multi-ROI feature which allows you to define up to 8 regions of the sensor array. When an image is acquired, only the pixel information from the defined regions will be readout of the sensor. The pixel data read out of the regions will then be combined together and will be transmitted from the camera as a single image.

The XML parameters related to Multi-ROI are as follows.

XML Parameters	Value	Description	
MultiROIControl	MultiROISelector	Region0 ~ Region7	Select the ROI to set.
	MultiROIMode	On/Off	Enables / Disables the selected ROI.
	MultiROIWidth	-	Width setting for the selected ROI
	MultiROIHeight	-	Height setting for the selected ROI
	MultiROIOffsetX	-	Horizontal offset from the origin to the selected ROI
	MultiROIOffsetY	-	Vertical offset from the origin to the selected ROI
	MultiROIValid ^a	-	Verifies the validation of the Multi-ROI setting values
	MultiROIStatus	Active/Inactive	Displays the status of the Multi-ROI feature. <ul style="list-style-type: none"> Active: The Multi-ROI feature is in use. Inactive: The Multi-ROI feature is not in use.

The unit for all parameters in this table is pixel.

a: If the setting values for the Multi-ROI feature are valid, 'True' will be returned or the check box will be selected.

Table 9.4 XML Parameters related to Multi-ROI

It is recommended that you first set the **Multi-ROI Width** parameter, since all of the regions must be the same width. The next step in the setup process is to define each individual region as desired. Up to 8 regions can be set up ranging from 0 through 7. Use the **Multi-ROI Selector** parameter to select which ROI to set and then set the ROI to On / Off by using the **Multi-ROI Mode** parameter. Then, set the **Multi-ROI Offset X**, **Multi-ROI Offset Y** and **Multi-ROI Height** parameters to define each region.

In the figure below, for example, three regions have been set. With these settings, the camera would output an image as follows:

- MultiROI Width × the total height of the three regions (Region0 Height + Region1 Height +Region2 Height)

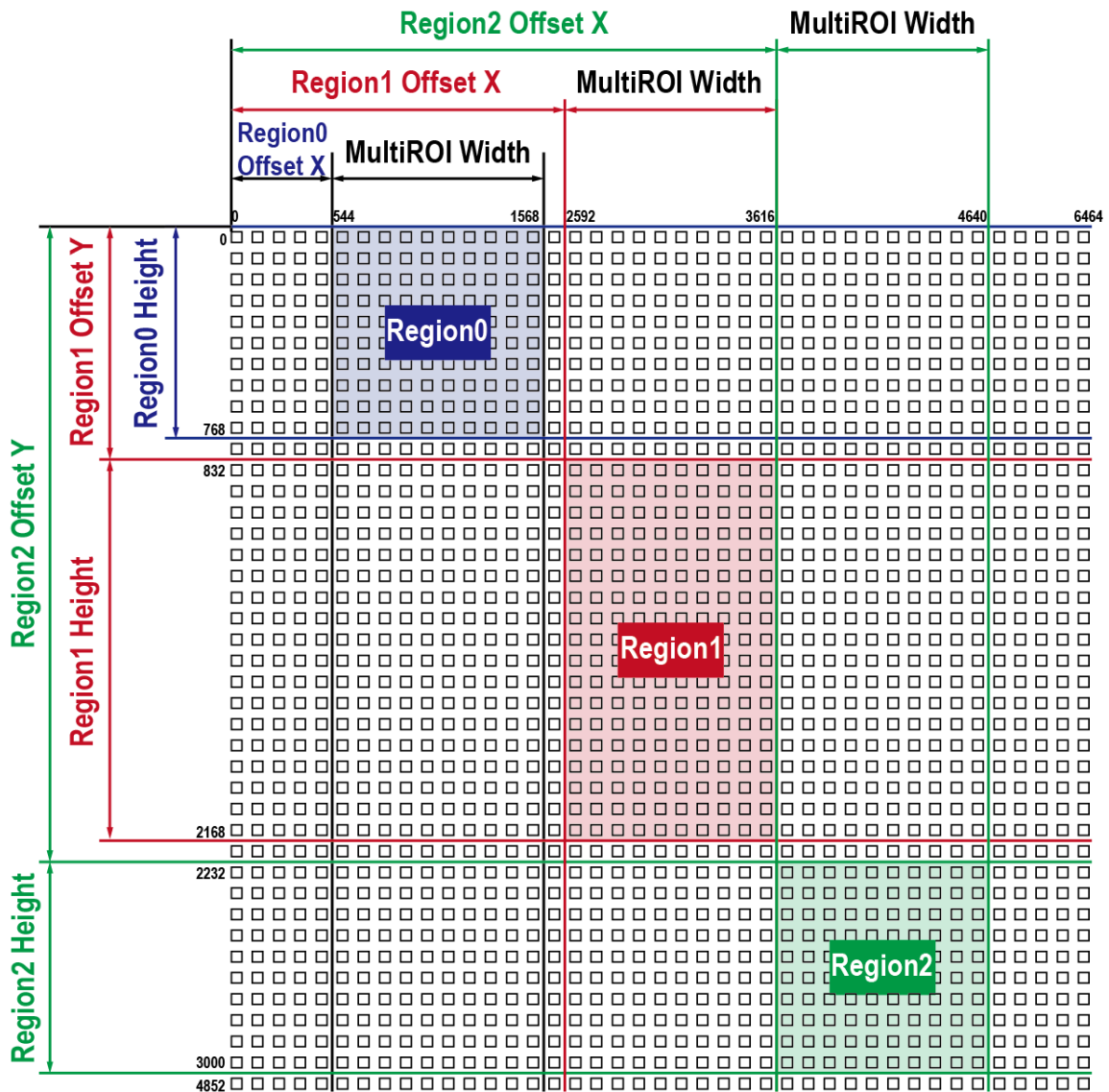

Figure 9.2 Multi-ROI

There are several things to keep in mind when setting the Multi-ROI feature on the VP-31MC-26 H camera:

- The sum of the Multi-ROI Offset X value plus the Multi-ROI Width value must not exceed the width of the camera's sensor.
- The sum of the Multi-ROI Offset Y value plus the Multi-ROI Height value must not exceed the height of the camera's sensor.
- The Multi-ROI Offset X and Multi-ROI Width value must be a multiple of 16.
- The Multi-ROI Offset Y and Multi-ROI Height value must be a multiple of 4.
- You can save the Multi-ROI setting values as a User Set and then load the values to the camera when desired. For more information refer to [9.25 User Set Control](#).

9.3 Binning (Monochrome Only)

The Binning has the effects of increasing the level value and decreasing resolution by summing the values of the adjacent pixels and sending them as one pixel. The XML parameters related to Binning are as follows.

XML Parameters		Value	Description
ImageFormatControl	BinningSelector	Sensor	Selects the Sensor for the binning engine. Applies the Binning in analog by the image sensor.
		Logic	N/A
	BinningHorizontalMode	Sum	Updated automatically according to the Binning Vertical Mode.
		Average	N/A
	BinningHorizontal	×1, ×2	Updated automatically according to the Binning Vertical.
	BinningVerticalMode	Sum	Adds pixel values from the adjacent pixels as specified in the Binning Vertical, and then sends them as one pixel.
		Average	N/A
	BinningVertical	×1, ×2	The number of vertical pixels to combine together.

Table 9.5 XML Parameters related to Binning

For example, if you set 2 × 2 binning, the camera's resolution is reduced to 1/4. If you set the **Binning Horizontal/Vertical Mode** to **Sum**, the maximum allowed resolution of the image is reduced to 1/2 and the responsivity of the camera is quadrupled. The **Width Max** and **Height Max** parameter, indicating the maximum allowed resolution of the image with the current camera settings, will be updated depending on the binning settings. The **Width**, **Height**, **Offset X** and **Offset Y** parameters also will be updated depending on the binning settings. You can verify the current resolution through the **Width** and **Height** parameters.

To apply the binning feature on the VP-31MC-26 H camera, you need to set the **Binning Vertical Mode** and **Binning Vertical** parameters. According to these values, the **Binning Horizontal Mode** and **Binning Horizontal** parameters will be updated automatically.

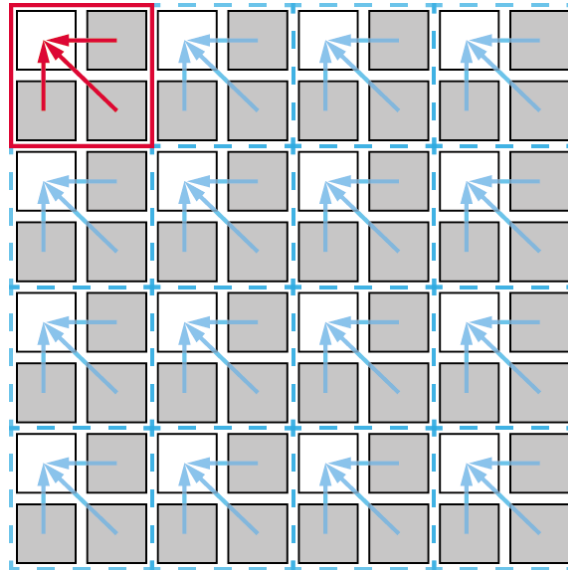

Figure 9.3 2 × 2 Binning

9.4 Frame Averaging

Frame Averaging is a digital image processing technique that is employed to enhance images contaminated by Shot Noise. Shot Noise is the noise associated with the random arrival of photons at an image sensor. It is a fundamental limit on noise performance in image sensors. By averaging a number (N) of frames, the Frame Averaging feature reduces Shot Noise and increases the signal to noise ratio (SNR) by a factor of \sqrt{N} . This decreases the frame rate by a factor of N. With the VP-31MC-26 H camera, you can average up to 16 frames, so that the signal to noise ratio will be increased by four times ($\sqrt{16} \equiv 12$ dB) and the frame rate will be decreased by a factor of 16.

The XML parameters related to Frame Averaging are as follows.

XML Parameters		Value	Description
FrameAveraging Control	FrameAveragingMode	Off	Disables the Frame Averaging feature.
		Average	Averages a number of frames as specified in the Frame Averaging Count parameter, and then outputs result images.
		Sum	Adds a number of frames as specified in the Frame Averaging Count parameter, and then outputs result images.
	FrameAveragingCount	2 ~ 16	Sets the number of frames to be used for the Frame Averaging feature.
	FrameAveragingReset	-	Resets the Frame Averaging feature and starts it again.
	FrameAveragingStatus	Disabled Idle Busy	Displays the status of the Frame Averaging feature. <ul style="list-style-type: none"> Disabled: The Frame Averaging feature is disabled. Idle: Waits for the first frame. Busy: The Frame Averaging feature is in use.
FrameAveraging CurrentCount	-	Displays the number of frames that have been used for the Frame Averaging feature.	

Table 9.6 XML Parameters related to Frame Averaging Control

9.5 Pixel Format

You can determine the pixel format (8 bits, 10 bits or 12 bits) of image data transmitted from the camera by using the **Pixel Format** parameter.

The XML parameter related to Pixel Format is as follows.

XML Parameter		Description
ImageFormatControl	PixelFormat	Sets the pixel format supported by the device.

Table 9.7 XML Parameter related to Pixel Format

The available pixel formats on the monochrome and color cameras are as follows.

Mono Sensor	Color Sensor
<ul style="list-style-type: none"> • Mono 8 • Mono 10 • Mono 12 	<ul style="list-style-type: none"> • Mono 8 • Mono 10 • Mono 12 • Bayer RG 8 • Bayer RG 10 • Bayer RG 12

Table 9.8 Pixel Format Values



Pixels tend to be more over-saturated with the 8 bit Pixel Format than with the 10 or 12 bit Pixel Format. This is true because the saturation capacity with the 8 bit Pixel Format is a quarter of that with the 10 or 12 bit Pixel Format.

9.6 Device Tap Geometry

The VP-31MC-26 H camera supports 2 Tap, 4 Tap, 8 Tap and 10 Tap Device Tap Geometry. The number of taps represents the number of pixel data that will be output on each cycle of the Camera Link Pixel Clock. The maximum allowed frame rate will be changed according to the Device Tap Geometry settings. The image data is transmitted in the interleaved order as shown in the figure below.

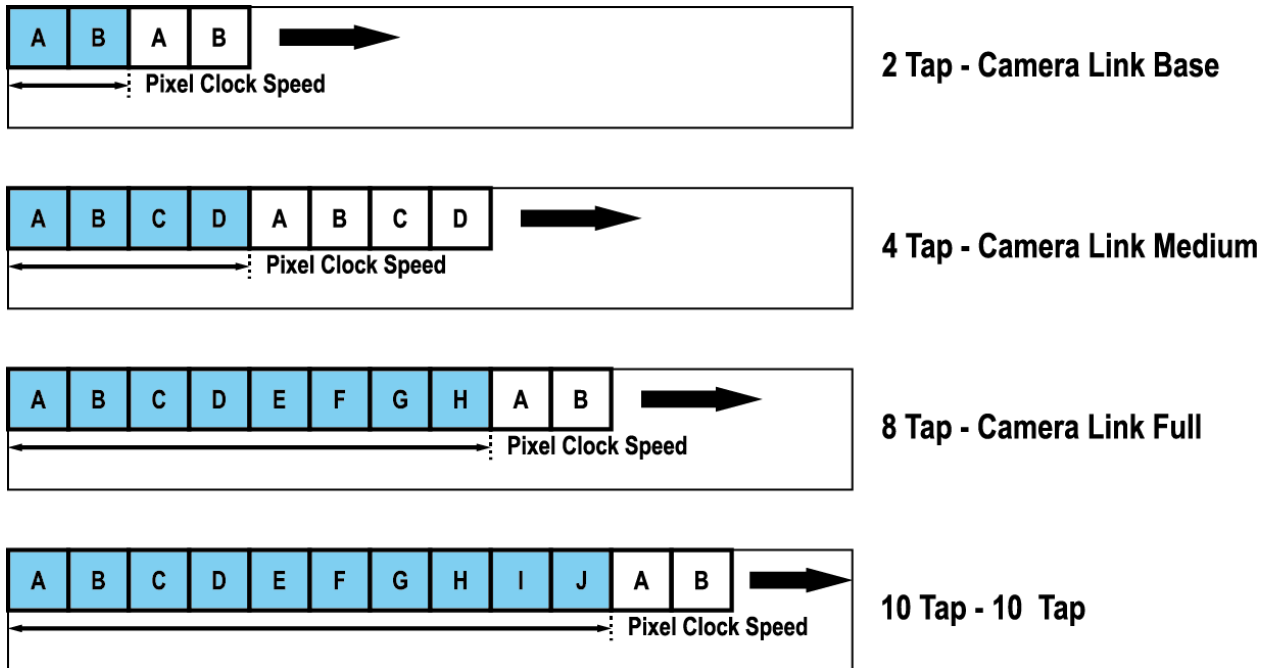

Figure 9.4 Device Tap Geometry

The XML parameter related to Device Tap Geometry is as follows.

XML Parameter		Value	Description
TransportLayer Control	DeviceTapGeometry	Geometry_1X2_1Y	Sets the Device Tap Geometry to 2 Tap.
		Geometry_1X4_1Y	Sets the Device Tap Geometry to 4 Tap.
		Geometry_1X8_1Y	Sets the Device Tap Geometry to 8 Tap.
		Geometry_1X10_1Y	Sets the Device Tap Geometry to 10 Tap.

Table 9.9 XML Parameter related to Device Tap Geometry

9.7 Camera Link Clock

The VP-31MC-26 H camera provides selectable Camera Link Pixel Clock speeds. The Pixel Clock speed determines the rate at which pixel data will be transmitted from the camera to the frame grabber in your computer via the Camera Link interface. Setting the camera for a higher Pixel Clock speed will increase the rate at which image data is transferred from the camera to the frame grabber. Before setting the camera's Pixel Clock speed, make sure you determine the maximum Pixel Clock speed supported by your frame grabber. Then, you should not attempt to set the camera's Pixel Clock speed that exceeds the maximum Pixel Clock speed for your frame grabber.

The XML parameters related to Camera Link Clock speed are as follows.

XML Parameters		Value	Description
CameraLink	CameraLinkClock	Clock0	Sets the Camera Link Clock speed to 85 MHz.
		Clock1	Sets the Camera Link Clock speed to 65 MHz.
	CameraLinkClockFrequency	-	Displays the current Camera Link Clock speed in MHz.

Table 9.10 XML Parameters related to Camera Link Clock Speed

9.8 Data ROI (Color Camera)

The White Balance Auto feature provided by the color camera uses the pixel data from a Data Region of Interest (ROI) to adjust the related parameters. The XML parameters related to Data ROI are as follows.

XML Parameters		Value	Description
DataRoiControl	RoiSelector	WhiteBalanceAuto	<ul style="list-style-type: none"> Selects a Data ROI used for White Balance Auto. Only available on the color camera
	RoiOffsetX	-	X coordinate of start point ROI
	RoiOffsetY	-	Y coordinate of start point ROI
	RoiWidth	-	Width of ROI
	RoiHeight	-	Height of ROI

Table 9.11 XML Parameters related to Data ROI

Only the pixel data from the area of overlap between the Data ROI by your settings and the Image ROI will be effective if you use the Image ROI and Data ROI at the same time. The effective ROI is determined as shown in the figure below.

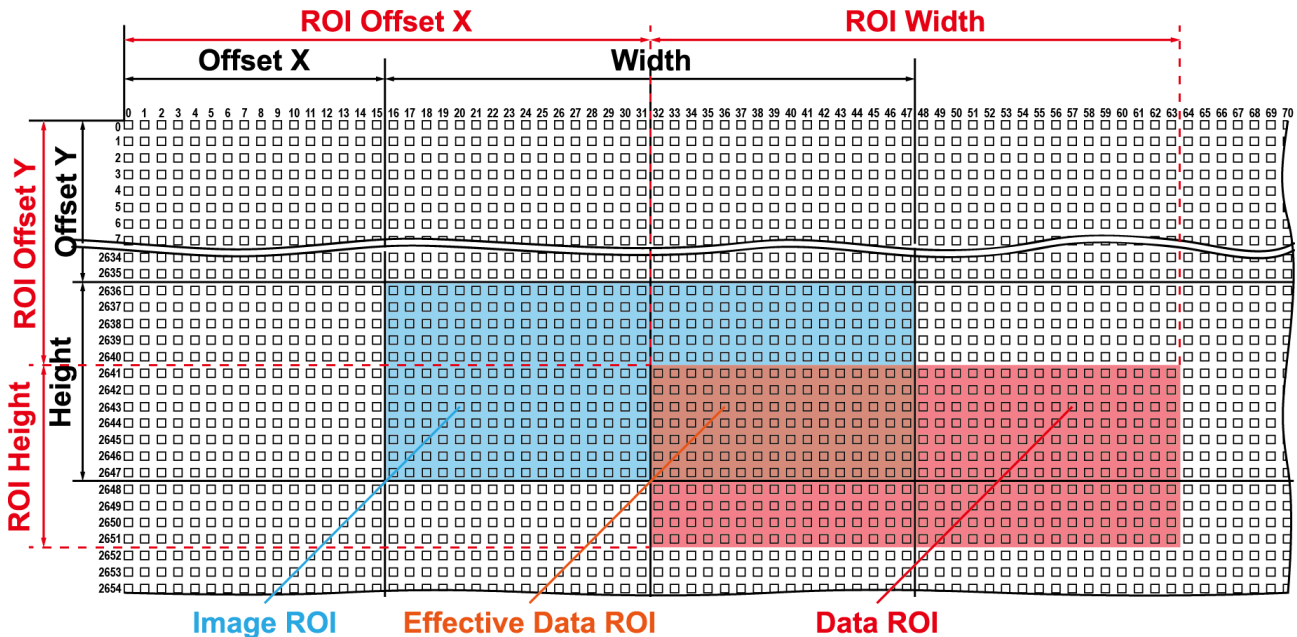

Figure 9.5 Effective Data ROI

9.9 White Balance (Color Camera)

The color camera includes the white balance capability to adjust the color balance of the images acquired from the image sensor. With the white balancing scheme used on the VP-31MC-26 H camera, the Red, Green and Blue intensities can be adjusted individually. You can set the intensity of each color by using the **Balance Ratio** parameter. The Balance Ratio value can range from 1.0 to 4.0. If the **Balance Ratio** parameter is set to 1.0 for a color, the intensity of the color will be unaffected by the white balance mechanism. If the **Balance Ratio** parameter is set to greater than 1.0, the intensity of the color will be proportionally increased to the ratio. For example, if the Balance Ratio is set to 1.5, the intensity of that color will be increased by 50%.

The XML parameters related to White Balance are as follows.

XML Parameters		Value	Description
AnalogControl	BalanceRatioSelector	Red	A Balance Ratio value will be applied to red pixels.
		Green	A Balance Ratio value will be applied to green pixels.
		Blue	A Balance Ratio value will be applied to blue pixels.
	BalanceRatio	1.0× ~ 4.0×	Adjusts the ratio of the selected color.

Table 9.12 XML Parameters related to White Balance

9.9.1 Balance White Auto

The Balance White Auto feature is implemented on the color camera. It will control the white balance of the image acquired from the color camera according to the GreyWorld algorithm. Before using the **Balance White Auto** feature, you need to set the Data ROI. If you do not set the Data ROI, the pixel data from the Image ROI will be used to control the white balance. As soon as the **Balance White Auto** parameter is set to **Once**, the Balance Ratio values for Red and Blue will be automatically adjusted to adjust the white balance by referring to Green. The XML parameter related to Balance White Auto is as follows.

XML Parameter		Value	Description
AnalogControl	BalanceWhiteAuto	Off	Balance White Auto Off
		Once	White Balance is adjusted once and then Off.

Table 9.13 XML Parameter related to Balance White Auto

9.10 Gain and Black Level

Increasing the **Gain** parameter increases all pixel values of the image. This results in a higher grey value output from the camera for a given amount of output from the image sensor.

1. Selects the Gain Control (Digital All is only available) to be adjusted by using the **Gain Selector** parameter.
2. Sets the Gain parameter to the desired value.

Adjusting the **Black Level** parameter will result in an offset to the pixel values output from the camera.

1. Selects the Black Level Control (Digital All is only available) to be adjusted by using the **Black Level Selector** parameter.
2. Sets the Black Level parameter to the desired value.

The XML parameters related to Gain and Black Level are as follows.

XML Parameters		Value	Description
Analog Control	GainSelector	Digital All	Applies the Gain value to all digital channels.
	Gain	1.0× ~ 32.0×	Sets a digital gain value.
	BlackLevelSelector	Digital All	Applies the Black Level value to all digital channels.
	BlackLevel	0 ~ 255	Sets a black level value (The setting range is based on the 12-bit pixel format.).

Table 9.14 XML Parameters related to Gain and Black Level

9.11 Defective Pixel Correction

The CMOS sensor may have defect pixels which cannot properly react to the light. The VP-31MC-26 H camera provides a feature to correct the defect pixels to enhance the quality of output images. Defect pixel information of the CMOS used for each camera is saved in the camera during the manufacturing process. If you want to add defect pixel information, it is required to enter the coordinate of new defect pixel into the camera. For more information, refer to [Appendix A](#).

9.11.1 Correction Method

A correction value for a defect pixel is calculated based on valid pixel values adjacent in the same line.

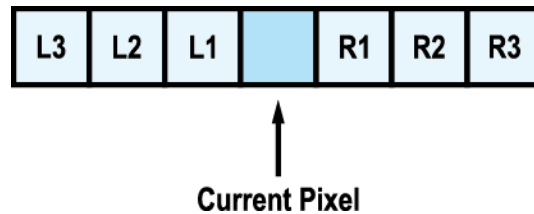

Figure 9.6 Location of Defect Pixel to be corrected

If the Current Pixel is a defect pixel as shown in the figure above, the correction value for this pixel is obtained as shown in the following table depending on whether surrounding pixels are defect pixels or not.

Adjacent Defect Pixel (s)	Correction Value of Current Pixel
None	$(L1 + R1) / 2$
L1	R1
R1	L1
L1, R1	$(L2 + R2) / 2$
L1, R1, R2	L2
L2, L1, R1	R2
L2, L1, R1, R2	$(L3 + R3) / 2$
L2, L1, R1, R2, R3	L3
L3, L2, L1, R1, R2	R3

Table 9.15 Calculation of Defect Pixel Correction Value

9.12 Photo Response Non-uniformity Correction

In theory, when a digital camera acquires images with the camera viewing a uniform light-colored target in bright light, all of the pixel values in the image should be near the maximum grey value and they should be equal.

In practice, however, slight variations in the performance of the pixels in the sensor, variations in the optics, and variations in the lighting will cause some variations in the pixel values output from the camera. This variation is known as Photo Response Non-Uniformity (PRNU). The VP-31MC-26 H camera provides the PRNU correction feature.

The XML parameters related to PRNU are as follows.

XML Parameters		Value	Description
PRNU	PRNUDataSelector	Default	Selects Default as a non-volatile memory location to load PRNU data from.
		Space1 - 3	Selects a user-defined location as a non-volatile memory location to save PRNU data to or load PRNU data from.
	PRNUDataGenerate	-	Generates the PRNU data for the current camera settings.
	PRNUDataSave	-	Saves the generated PRNU data in the non-volatile memory. <ul style="list-style-type: none"> The generated data by executing the PRNU Data Generate command are saved in the volatile memory so that the data are lost if the camera is reset or if power is turned off. To use the data after the camera is powered on or reset, save it in the non-volatile memory.
	PRNUDataLoad	-	Loads the PRNU data from the non-volatile memory into the volatile memory.

Table 9.16 XML Parameters related to PRNU

9.12.1 Generating and Saving User PRNU Correction Values

To generate and save user-defined PRNU correction values, use the following procedure.



- To generate the optimum PRNU data,
 - set the FFC feature to Off before generating PRNU correction values.
 - the grey reference image must be acquired at uniform illumination. We strongly recommend that you use a high quality light source to deliver uniform illumination. Standard illumination may not be appropriate.
- The PRNU correction values stored in Default are optimized for use in typical situations and will provide good camera performance in most cases. Use of the values stored in Default is recommended.

1. To generate PRNU correction values suitable for your operating conditions, set the ROI to the actual settings you will be using during normal operation. We strongly recommend that you use the Default PRNU correction values stored in Default if you cannot set up the uniform illumination.
2. Without mounting a lens on the camera, place a uniform illumination (e.g. backlight) in the field of view of the camera. Set up the camera as you would for normal operation. We recommend that you make adjustments to achieve the digital output level in a range from 150 to 200 (Gain: 1.00 at 8 bit).
3. Begin acquiring images by setting the camera for the Free-Run mode.
4. Execute the **PRNU Data Generate** command to generate PRNU correction values for the current camera settings.
5. The generated PRNU correction values will be activated and saved in the camera's volatile memory.
6. To save the generated PRNU correction values in the camera's Flash (non-volatile) memory, use the **PRNU Data Selector** parameter to specify a location to save the PRNU correction values, and then execute the **PRNU Data Save** command. The previous PRNU values saved in the memory will be overwritten.
To disregard the generated PRNU correction values and load the existing values in the Flash memory, use the **PRNU Data Selector** parameter to select a desired PRNU correction values, and then execute the **PRNU Data Load** command.

9.13 Flat Field Correction

The Flat Field Correction feature improves the image uniformity when you acquire a non-uniformity image due to external conditions. The Flat Field Correction feature can be summarized by the following equation:

$$IC = (IR \times M) / IF$$

IC: Level value of corrected image

IR: Level value of original image

M: Target value of image after correction

IF: Level value of Flat Field data

Under actual use conditions, generate Flat Field Correction data and save the Flat Field Correction data into the camera's non-volatile memory according to the following procedure.

1. Select **Auto** or **User Set** by using the **Flat Field Target Selector** parameter.
 - **Auto:** The camera automatically adjusts the target value of the image after correction.
 - **User Set:** Allows you to set the user-defined target value of the image by using the **Flat Field Target Level** parameter.
2. Execute the **Flat Field Data Generate** parameter.

After executing the **Flat Field Data Generate** parameter, you must acquire one image to generate the scaled-down Flat Field correction data.
3. Use the **Flat Field Data Selector** parameter to specify a location to save the generated Flat Field correction data.
4. Execute the **Flat Field Data Save** parameter to save the generated Flat Field correction data into the non-volatile memory. The scaled-down Flat Field correction data will be expanded and then applied as shown in the Figure 9.8 when it is used for correction.

To disregard the generated Flat Field correction data and use the previous Flat Field correction data, execute the **Flat Field Data Load** parameter before executing the **Flat Field Data Save** parameter.
5. Set the **Flat Field Correction** parameter to **On** to apply the Flat Field correction data to the camera.



- It is recommended that you enable the **Defective Pixel Correction** feature before generating the Flat Field correction data.
- Before executing the **Flat Field Data Generate** parameter, you must set the camera as follows:
 - OffsetX, Y: 0
 - Width, Height: Maximum values
- After executing an **Acquisition Start** command, you need to operate the camera in the free-run mode or apply a trigger signal to acquire an image.



FFC for the color cameras

When you set the **Pixel Format** parameter to a Bayer pattern (Bayer RG 8/10/12) and enable the Flat Field Correction feature on the color camera, the FFC will be performed for each color pixel (red, green1, green2 and blue) separately. This significantly removes image artifacts to improve pixel to pixel color uniformity.

The XML parameters related to Flat Field Correction are as follows.

XML Parameters	Value	Description	
FlatField Control	FlatFieldCorrection	Off	Disables the Flat Field Correction feature.
		On	Enables the Flat Field Correction feature.
	FlatFieldDataSelector	Space0 – Space23	Selects a location to save Flat Field data to or load Flat Field data from. <ul style="list-style-type: none"> Space0 – Space23: User defined locations
	FlatFieldTargetSelector	Auto	Auto-adjusts the target value of the image after correction.
		User Set	Manually sets the target value of the image after correction.
	FlatFieldTargetLevel	1 - 4095	Sets the target value of the image after correction when Flat Field Target Selector is set to User Set . <ul style="list-style-type: none"> The setting range is based on the 12-bit Pixel Format.
	FlatFieldDataGenerate	-	Generates the Flat Field data.
	FlatFieldDataSave	-	Saves the generated Flat Field correction data in the non-volatile memory. <ul style="list-style-type: none"> The data generated by executing the Flat Field Data Generate parameter are saved in the volatile memory so that the data are lost if the camera is reset or if power is turned off. To use the data after the camera is powered on or reset, save them in the non-volatile memory.
FlatFieldDataLoad	-	Loads the Flat Field correction data from the non-volatile memory into the volatile memory.	

Table 9.17 XML Parameters related to Flat Field Correction

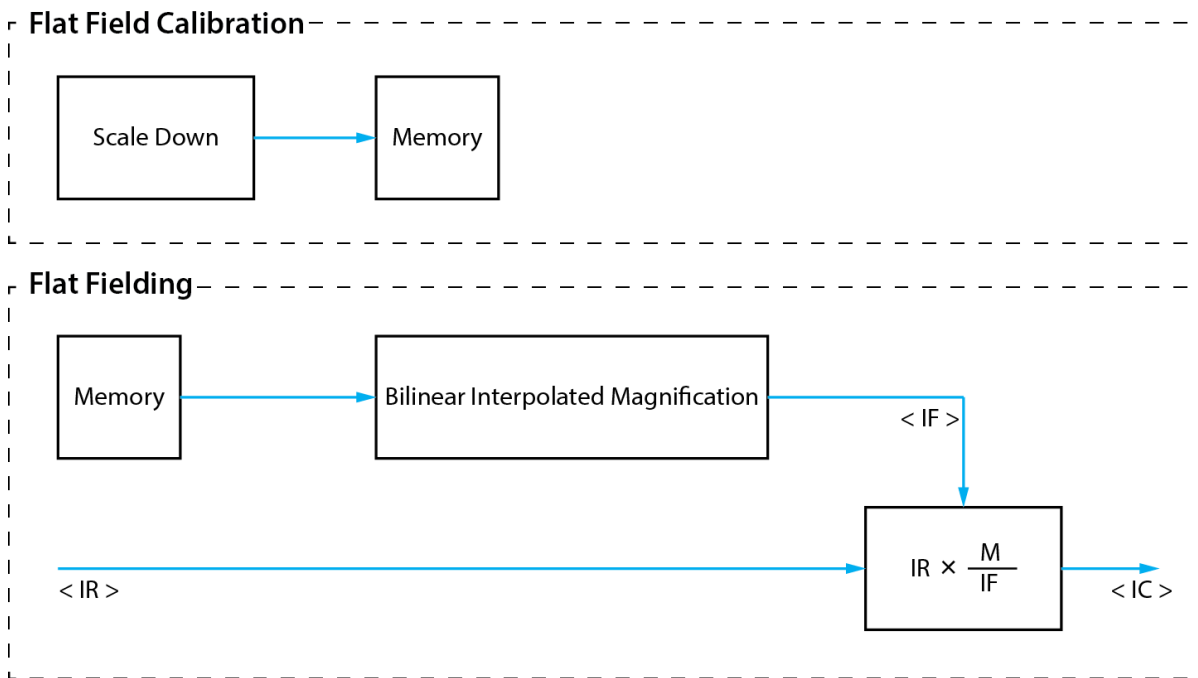

Figure 9.7 Generation and Application of Flat Field Data

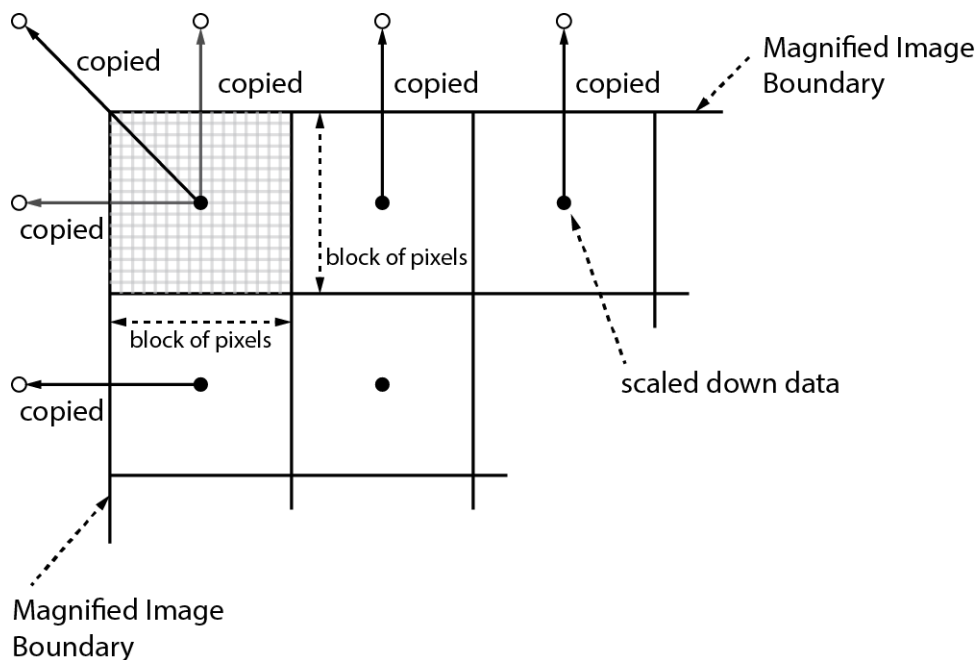

Figure 9.8 Bilinear Interpolated Magnification

9.13.1 Flat Field Data Selector

As mentioned above, the generated Flat Field correction data are stored in the camera's volatile memory and the data are lost if the camera is reset or powered off. To use the generated Flat Field correction data after the camera is powered on or reset, you need to save them in the camera's non-volatile memory. The VP-31MC-26 H camera provides 24 reserved locations in the camera's non-volatile memory available for saving and loading the Flat Field correction data. You can use the **Flat Field Data Selector** parameter to select a location as desired.

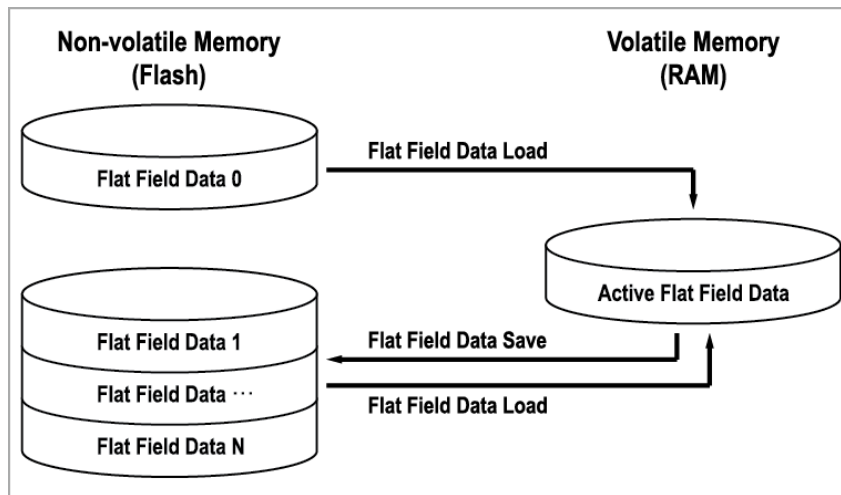

Figure 9.9 Flat Field Data Selector

Saving Flat Field Data

In order to save the active Flat Field data into a reserved location in the camera's Flash memory, follow the procedure below.

1. Use the **Flat Field Data Selector** parameter to specify a location to save the active Flat Field data.
2. Execute the **Flat Field Data Save** parameter to save the active Flat Field data to the selected location.

Loading Flat Field Data

If you saved Flat Field correction data into the camera's non-volatile memory, you could load the saved Flat Field correction data from the camera's non-volatile memory into the camera's active Flat Field data location.

1. Use the **Flat Field Data Selector** parameter to specify a reserved location whose Flat Field correction data will be loaded into the camera's active Flat Field data location.
2. Execute the **Flat Field Data Load** parameter to load the selected Flat Field correction data into the active Flat Field data location.

9.14 Digital I/O Control

The Control I/O receptacle of the camera can be operated in various modes.

The XML parameters related to Digital I/O Control are as follows.

XML Parameters		Value	Description
DigitalIOControl	LineSelector	Line0	Selects the number 1 pin of the camera's Control I/O receptacle as an input line.
		Line1	Selects the number 4 pin of the camera's Control I/O receptacle as an output line.
	LineMode	Input	Sets the Line Mode of the selected physical line (1) to Input.
		Output	Sets the Line Mode of the selected physical line (4) to Output.
	LineInverter	FALSE	Disables inversion on the output signal of the line.
		TRUE	Enables inversion on the output signal of the line.
	LineSource	Off	Disables the line output.
		ExposureActive	Outputs pulse signals indicating the current exposure time.
		FrameActive	Outputs pulse signals indicating a frame readout time.
		UserOutput0	Outputs pulse signals set by User Output Value.
		Timer0Active	Outputs user-defined Timer signals as pulse signals.
	UserOutputValue	FALSE	Sets the bit state of the line to Low.
		TRUE	Sets the bit state of the line to High.
	DebounceTime	0 – 1,000,000	Sets a Debounce Time in microseconds (Default: 0.5 μ s).

Table 9.18 XML Parameters related to Digital I/O Control

When you set the **Line Source** to **User Output0**, you can use the user setting values as output signals.

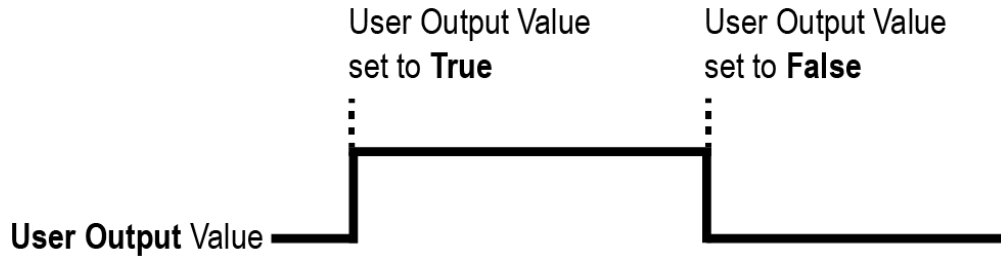

Figure 9.10 User Output

The camera can provide an Exposure Active output signal. The signal goes high when the exposure time for each frame acquisition begins and goes low when the exposure time ends as shown in the figure below. This signal can be used as a flash trigger and is also useful when you are operating a system where either the camera or the object being imaged is movable. Typically, you do not want the camera to move during exposure. You can monitor the Exposure Active signal to know when exposure is taking place and thus know when to avoid moving the camera.

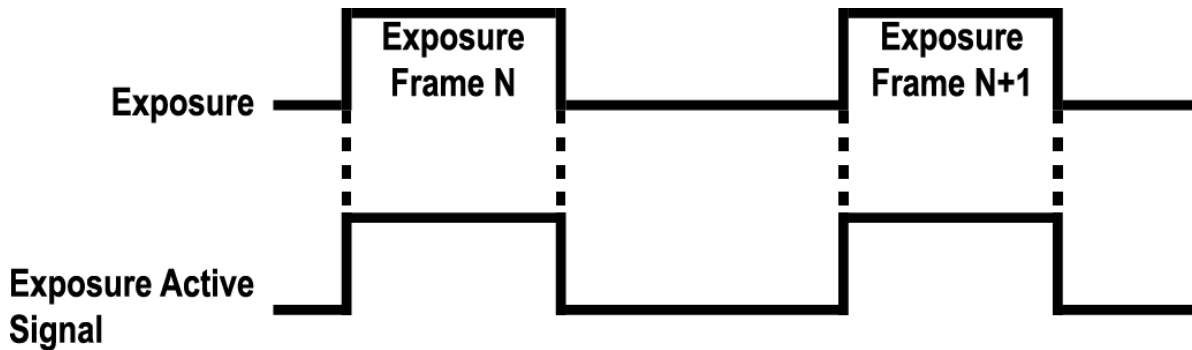

Figure 9.11 Exposure Active Signal

9.14.1 Debounce

The Debounce feature of the VP-31MC-26 H camera allows to supply only valid signals to the camera by discriminating between valid and invalid input signals. The **Debounce Time** parameter specifies the minimum time that an input signal must remain High or Low in order to be considered as a valid input signal. When you use the Debounce feature, be aware that there is a delay between the point where the valid input signal arrives and the point where the signal becomes effective. The duration of the delay is determined by the Debounce Time parameter setting value. When you set the **Debounce Time** parameter, High and Low signals shorter than the setting value are considered invalid and ignored as shown in the figure below.

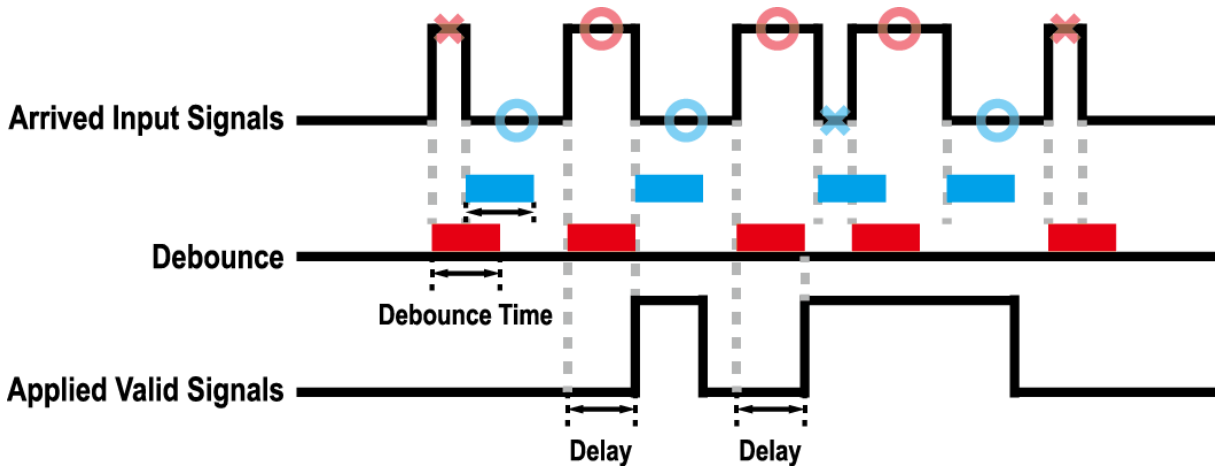

Figure 9.12 Debounce

The XML parameter related to Debounce Time is as follows.

XML Parameter		Value	Description
DigitalIOControl	DebounceTime	0 – 1,000,000 μ s	Sets a Debounce Time in microseconds. (Default: 0.5 μ s)

Table 9.19 XML Parameter related to Debounce Time

9.15 Timer Control

When the **Line Source** parameter is set to **Timer0Active**, the camera can provide output signals by using the Timer. On the VP-31MC-26 H camera, the Frame Active, Exposure Active event or external trigger signal is available as Timer source signal.

The XML parameters related to Timer are as follows.

XML Parameters		Value	Description	
CounterAnd TimerControl	TimerDuration	1 – 60,000,000 μ s	Sets the duration of the Timer output signal when the Timer Trigger Activation is set to Falling/Rising Edge.	
	TimerDelay	0 – 60,000,000 μ s	Sets the delay time to be applied before starting the Timer.	
	TimerReset	-	Resets the Timer and starts it again.	
	TimerStatus	TimerIdle		Indicates that the Timer is in idle state.
		TimerTriggerWait		Indicates that the Timer is waiting for a trigger signal.
		TimerActive		Indicates that the Timer is in active state.
	TimerTrigger Source	Off		Disables the Timer trigger.
		ExposureActive		Sets the Timer to use the current exposure time as the source signal.
		FrameActive		Sets the Timer to use a frame readout time as the source signal.
	TimerTrigger Activation	Line0		Sets the Timer to use the external trigger signal as the source signal.
		RisingEdge		Specifies that a rising edge of the selected trigger signal will act as the Timer trigger.
		FallingEdge		Specifies that a falling edge of the selected trigger signal will act as the Timer trigger.
		LevelHigh		Specifies that the Timer output signal will be valid as long as the selected trigger signal is High.
		LevelLow		Specifies that the Timer output signal will be valid as long as the selected trigger signal is Low.

Table 9.20 XML Parameters related to Timer Control

For example, when the Timer Trigger Source is set to Exposure Active and the Timer Trigger Activation is set to Level High, the Timer will act as follows:

1. When the source signals set by the Timer Trigger Source parameter are applied, the Timer will start operations.
2. The delay set by the Timer Delay parameter begins to expire.
3. When the delay expires, the Timer signal goes high as long as the source signal is high.

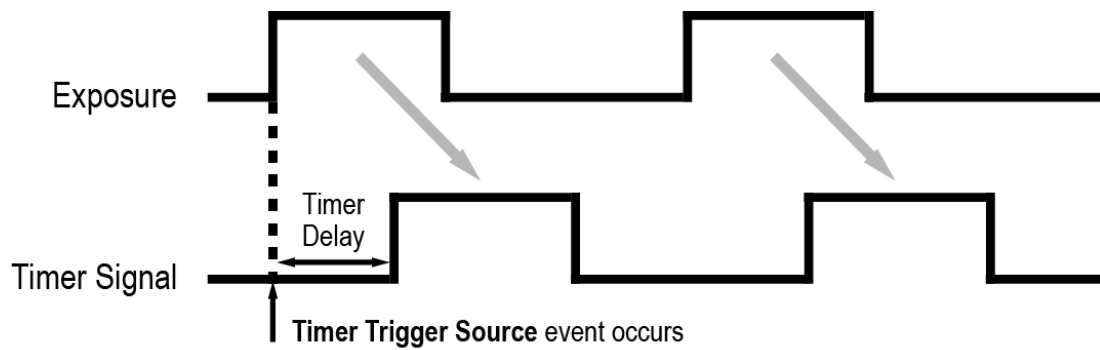

* Timer Trigger Activation is set to Level High.

Figure 9.13 Timer Signal

9.16 Cooling Control

A fan is installed on the rear panel of the camera and Thermoelectric Peltier is installed inside the camera to control the image sensor temperature. You can set the fan and Peltier to turn on or off. You can also set the Peltier to turn on when a specified internal temperature is reached.

The XML parameters related to Cooling Control are as follows.

XML Parameters		Value	Description
CoolingControl	TargetTemperature	-10°C - 80°C	Sets the temperature to operate the Thermoelectric Peltier when the Peltier Operation Mode parameter is set to On.
	FanOperationMode	Off	Turns off the fan.
		On	Turns on the fan.
	FanSpeed	-	Displays the current Fan RPM.
	PeltierOperationMode	Off	Turns off the Thermoelectric Peltier.
On		Turns on the Thermoelectric Peltier when the internal temperature exceeds the value set in the Target Temperature parameter.	

Table 9.21 XML Parameters related to Cooling Control

9.17 Temperature Monitor

The camera has an embedded sensor chip to monitor the internal temperature.

The XML parameters related to Device Temperature are as follows.

XML Parameters		Value	Description
DeviceControl	DeviceTemperatureSelector	Sensor	Sets a temperature measuring spot to the image sensor.
		Mainboard	Sets a temperature measuring spot to the mainboard.
	DeviceTemperature	-	Displays device temperature in Celsius.

Table 9.22 XML Parameters related to Device Temperature

9.18 Status LED

A LED is installed on the rear panel of the camera to inform the operation status of the camera. LED status and corresponding camera status are as follows:

Status LED	Description
Steady Red	The camera is not initialized.
Fast Flashing Green	The camera is transmitting image data.

Table 9.23 Status LED

9.19 Test Pattern

To check whether the camera operates normally or not, it can be set to output test patterns generated in the camera, instead of image data from the image sensor. Four types of test patterns are available; images with different values in horizontal direction (Grey Horizontal Ramp), images with different values in diagonal direction (Grey Diagonal Ramp), moving images with different values in diagonal direction (Grey Diagonal Ramp Moving) and images with different values in horizontal direction output from the image sensor (Sensor Specific).

The XML parameter related to Test Pattern is as follows.

XML Parameter		Value	Description
ImageFormatControl	TestPattern	Off	Disables the Test Pattern feature.
		GreyHorizontalRamp	Sets to Grey Horizontal Ramp.
		GreyDiagonalRamp	Sets to Grey Diagonal Ramp.
		GreyDiagonalRampMoving	Sets to Grey Diagonal Ramp Moving.
		SensorSpecific	Sets to the Test Pattern generated by the image sensor.

Table 9.24 XML Parameter related to Test Pattern

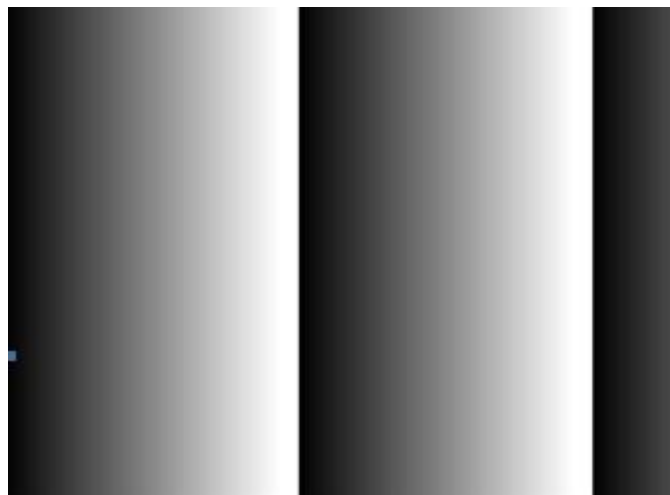

Figure 9.14 Grey Horizontal Ramp

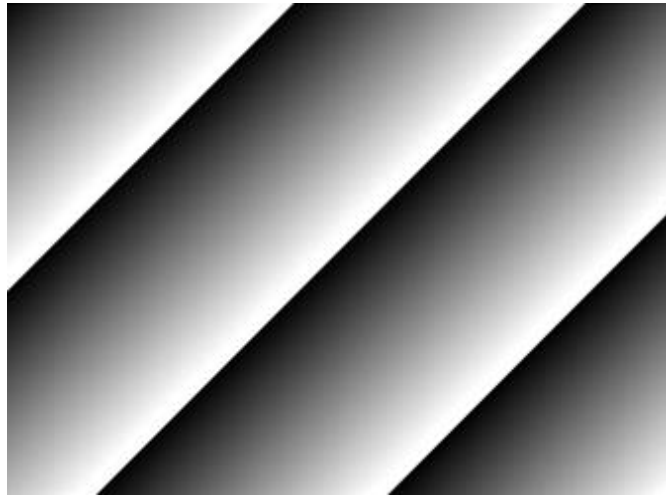

Figure 9.15 Grey Diagonal Ramp

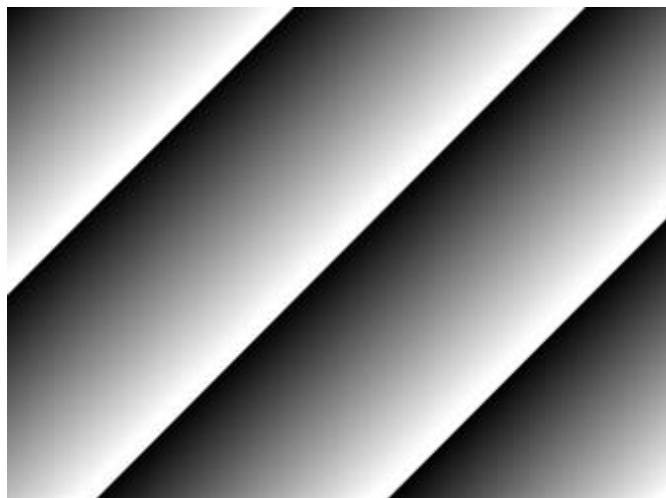

Figure 9.16 Grey Diagonal Ramp Moving

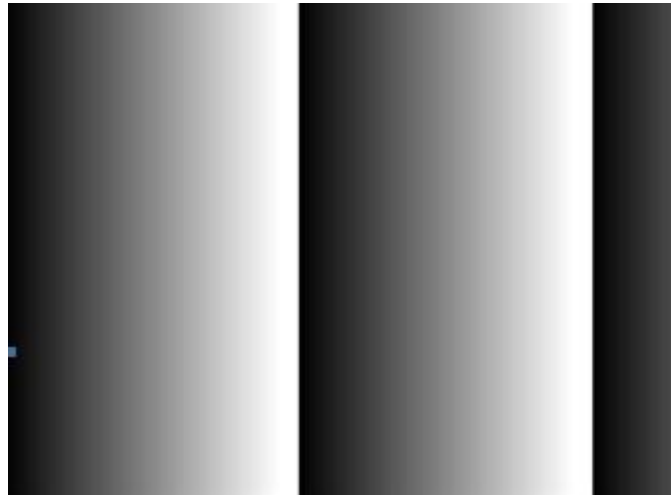

Figure 9.17 Sensor Specific



The test pattern may look different because the region of the test pattern may vary depending on the camera's resolution settings.

9.20 Reverse X

The Reverse X feature lets you flip images horizontally. This feature is available in all operation modes of the camera. The XML parameter related to Reverse X is as follows.

XML Parameter		Value	Description
ImageFormatControl	ReverseX	FALSE	Disables the Reverse X feature.
		TRUE	Flips images horizontally.

Table 9.25 XML Parameter related to Reverse X



Figure 9.18 Original Image

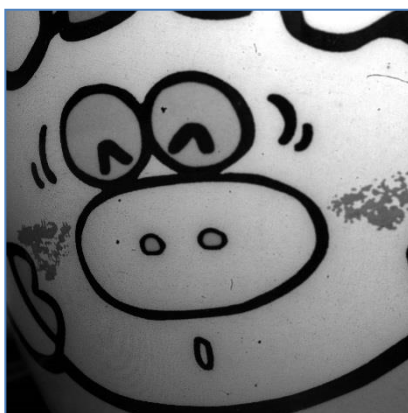

Figure 9.19 Reverse X Image

9.21 Reverse Y

The Reverse Y feature lets you flip images vertically. This feature is available in all operation modes of the camera. The XML parameter related to Reverse Y is as follows.

XML Parameter		Value	Description
ImageFormatControl	ReverseY	FALSE	Disables the Reverse Y feature.
		TRUE	Flips images vertically.

Table 9.26 XML Parameter related to Reverse Y



Figure 9.20 Original Image



Figure 9.21 Reverse Y Image



- When you use the **Reverse Y** feature, you must generate camera's FFC data again.
- When the **Pixel Format** parameter is set to **Bayer** and the **Reverse Y** feature is enabled on the color camera, the alignment of the color filter will be changed.

9.22 Device User ID

You can input user-defined information up to 16 bytes.

The XML parameter related to Device User ID is as follows.

XML Parameter		Description
DeviceControl	DeviceUserID	Input user-defined information (16 bytes).

Table 9.27 XML Parameter related to Device User ID

9.23 Device Reset

Resets the camera physically to power off and on.

The XML parameter related to Device Reset is as follows.

XML Parameter		Description
DeviceControl	DeviceReset	Resets the camera physically.

Table 9.28 XML Parameter related to Device Reset

9.24 Field Upgrade

The camera provides a feature to upgrade the Firmware and FPGA logic through the Camera Link interface without disassembling the camera in the field. Refer to [Appendix B](#) for more details about how to upgrade.

9.25 User Set Control

You can save the current camera settings to the camera's internal Flash memory. You can also load the camera settings from the camera's internal Flash memory. The camera provides two setups to save and three setups to load settings.

The XML parameters related to User Set Control are as follows.

XML Parameters		Value	Description
UserSetControl	UserSetSelector	Default	Selects the Factory Default settings.
		UserSet1	Selects the User Set1 settings.
		UserSet2	Selects the User Set2 settings.
	UserSetLoad	-	Loads the User Set specified by User Set Selector to the camera.
	UserSetSave	-	Saves the current settings to the User Set specified by User Set Selector. <ul style="list-style-type: none"> The Default is a Factory Default settings and allowed to load only.
	UserSetDefault	Default	Applies the Factory Default settings when reset.
		User Set1	Applies the User Set1 settings when reset.
		User Set2	Applies the User Set2 settings when reset.

Table 9.29 XML Parameters related to User Set Control

The camera settings stored in the Default can be loaded into the camera's workspace but cannot be changed. The settings set in the workspace will be lost if the camera is reset or powered off. To use the current setting values in the workspace after a reset, you must save the settings to one of the user spaces.

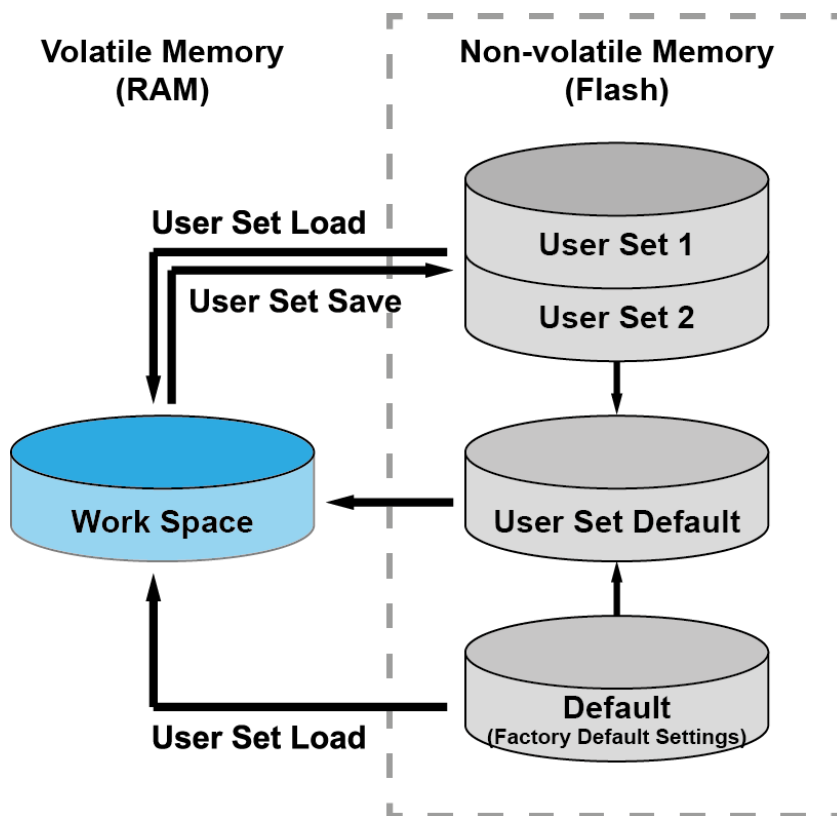

Figure 9.22 User Set Control

9.26 Sequencer Control

The Sequencer Control provided by the VP-31MC-26 H camera allows you to apply different sets of parameter setting, called 'Sequencer Set', to a sequence of image acquisitions. As the camera acquires images, it applies one Sequencer Set after the other. This allows the camera to respond quickly to changing imaging requirements. For example, changes in illumination conditions influence the imaging requirements.

With the User Set Control feature, you can save user defined Sequencer Sets in the camera's non-volatile memory. Then after the camera is powered on or reset, the Sequencer Sets are available according to the **User Set Default** parameter. Each Sequencer Set is identified by an index number ranging from 0 to 31. Accordingly, you can define up to 32 different Sequencer Sets.

On the VP-31MC-26 H camera, only the Flat Field correction data can be configured for Sequencer Sets.

The XML parameters related to Sequencer Control are as follows.

XML Parameters		Value	Description
SequencerControl	SequencerMode	Off	Disables the Sequencer.
		On	Enables the Sequencer.
	SequencerConfigurationMode	Off	Disables the Sequencer Configuration Mode.
		On	Enables the Sequencer Configuration Mode.
	SequencerSetSelector	0 – 31	Selects an index number of a Sequencer Set to be configured.
	SequencerSetActive	-	Displays the index number (0 – 31) of the Sequencer Set that is currently active.
	SequencerSetCount	1 – 32	Sets the number of Sequencer Sets to be applied.
SequencerReset	-	Returns to Sequencer Set 0.	

Table 9.30 XML Parameters related to Sequencer Control



To apply Sequencer Sets, you must first set the **Trigger Mode** parameter to **On**.

Use Case – Applying Four Different Flat Field Correction Data to Sequencer Sets

For example, assume that four different Flat Field correction data optimized for White, Green, Red and Blue pixels are applied to four different Sequencer Sets to inspect LCD panels.

1. Set the **Sequencer Mode** parameter to **Off**.
2. Set the **Sequencer Configuration Mode** parameter to **On**.
3. Set the **Sequencer Set Selector** parameter to **0** and set the **Flat Field Data Selector** parameter to **0**.
Then, set the **Sequencer Set Selector** parameter to **1, 2 and 3**, and then set the **Flat Field Data Selector** parameter to **1, 2 and 3** respectively.
4. Set the **Sequencer Set Count** parameter to **4**.
5. Set the **Sequencer Configuration Mode** parameter to **Off**, and then set the **Sequencer Mode** parameter to **On**.

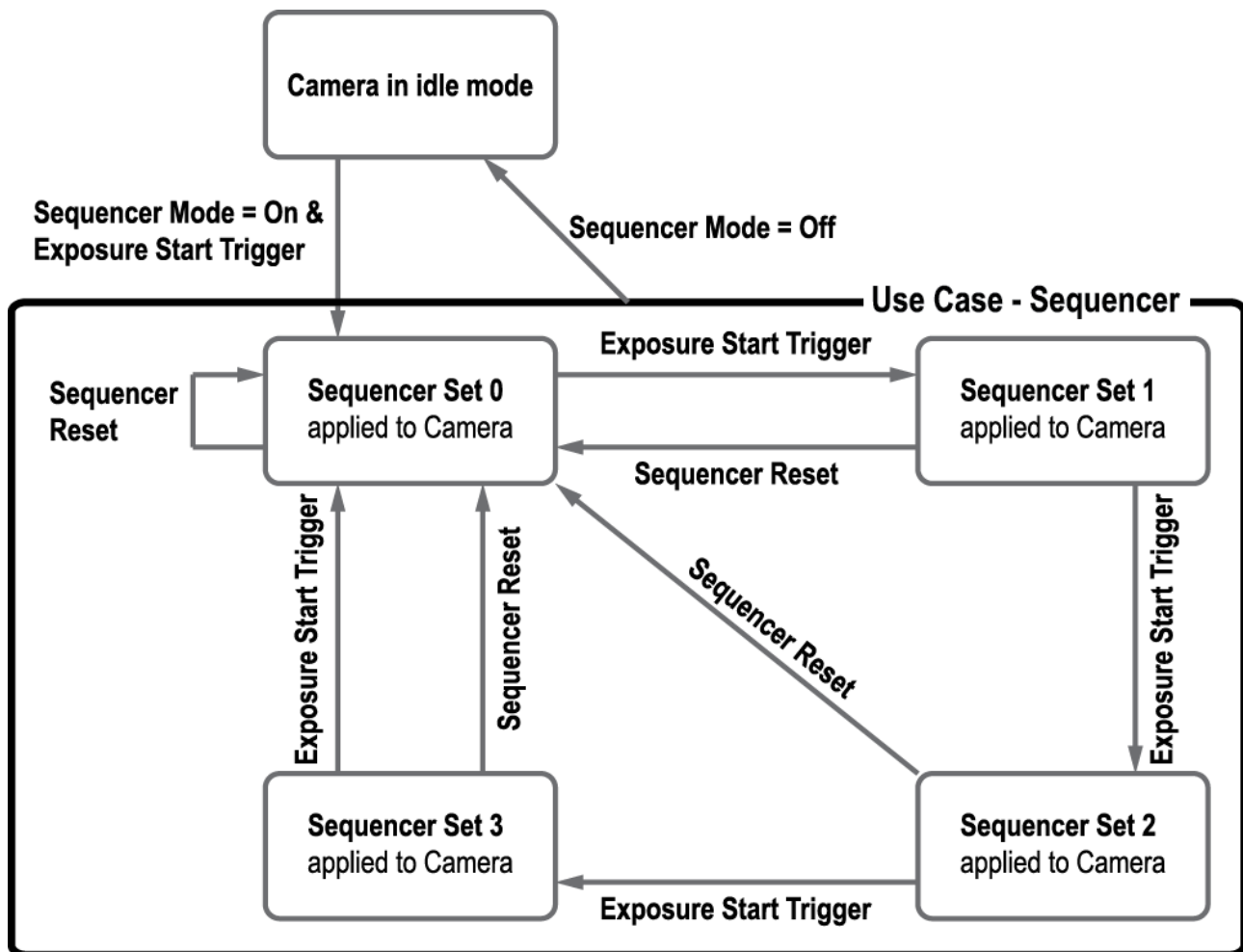

Figure 9.23 Sequencer Diagram (Use Case)



- You can save the user defined Sequencer Sets in the camera's non-volatile memory by using the **User Set Control** feature. For more information, refer to [9.25 User Set Control](#).
- Executing the **Sequencer Reset** parameter allows to return to the **Sequencer Set 0** status at any time while cycling through the Sequencer.

10 Camera Configuration

10.1 Serial Communication

You can configure all camera settings via RS-644 serial communication of the Camera Link interface. When you want to control the camera by using a terminal or access directly to the camera by using your application, you need to set your network as follows:

- Baud Rate: 115200 bps
- Data Bit: 8 bit
- Parity Bit: No parity
- Stop Bit: 1 stop bit
- Flow Control: None

10.2 Actual Runtime of Parameters

When you set a parameter, the actual runtime of the parameter varies depending on the type of the parameter and the operating status of the camera. All parameters except the Exposure Time parameter are applied to change the camera settings as illustrated below, on the rising edge of a REQ_Frame signal before starting the readout process. When you change the Exposure Time parameter, the exposure time setting will be changed and applied at the starting of the exposure. If you operate the camera with the Trigger Mode parameter set to On, you must change parameters before applying the trigger signals in order to synchronize image outputs with the parameters. If you change a parameter in the Free-Run mode, you may acquire up to two images that are not affected by the parameter change. This is true because it is hard to verify the current operating status of the camera in the Free-Run mode.

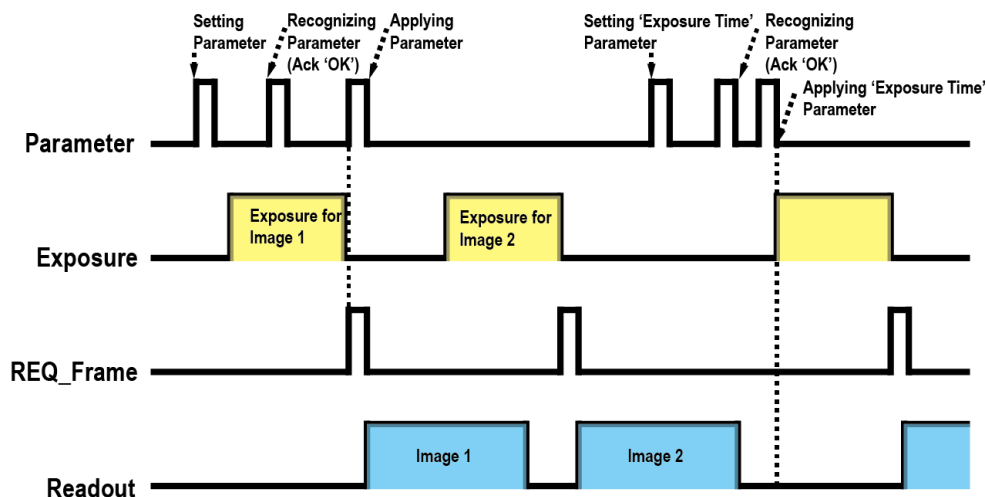

Figure 10.1 Actual Runtime of Parameters

10.3 Configurator

The Configurator, a sample application, is provided to control Vieworks Camera Link cameras.

The Configurator allows you to change the camera's parameters and control the camera.

10.3.1 Starting the Configurator

After connecting the camera to your computer (refer to [6. Connecting the Camera](#)), you can run the Configurator by following the procedure below.

1. Execute the Configurator.exe file after the camera is powered on. The **Camera Scan** window appears.
2. The Configurator probes if a camera is connected to your computer and then displays the model name of the connected camera in the Camera Scan window.
3. Right-click the model name of the camera, and then click the **Add to List** menu. By adding a Vieworks Camera Link camera which supports XML-based control to the list, you can configure the camera with a newer version of the Configurator.

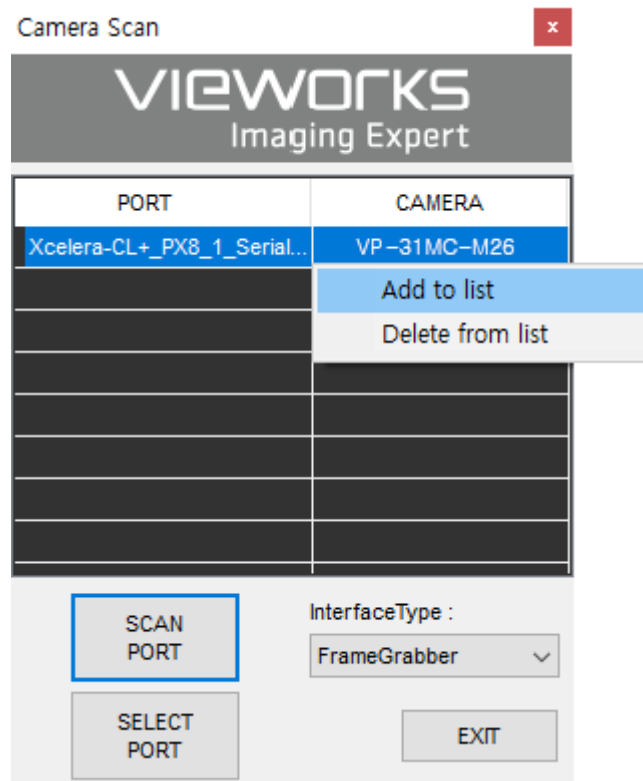

Figure 10.2 Add to list in the Camera Scan window

4. Double-click the model name of the camera. The **Device Property** and **Configurator Plus** windows appear.
 - The **Device Property** window displays controls for setting camera parameters.

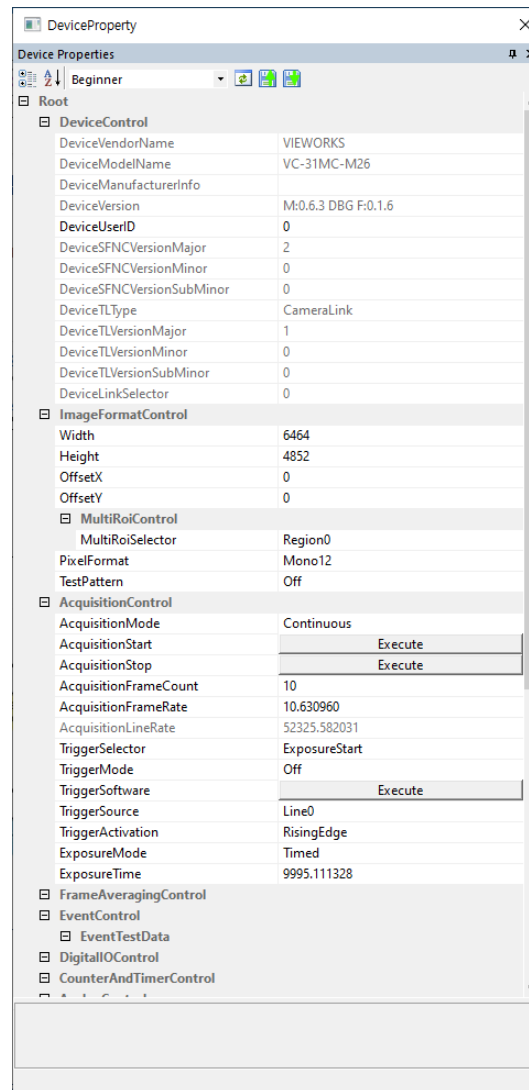

Figure 10.3 Device Property

- In the **Configurator Plus** window, you can display the **Device Property** and/or **Device Maintenance** windows. In the **Device Maintenance** window, you can download a Defective Pixel Map or upgrade camera's MCU, FPGA and XML files.

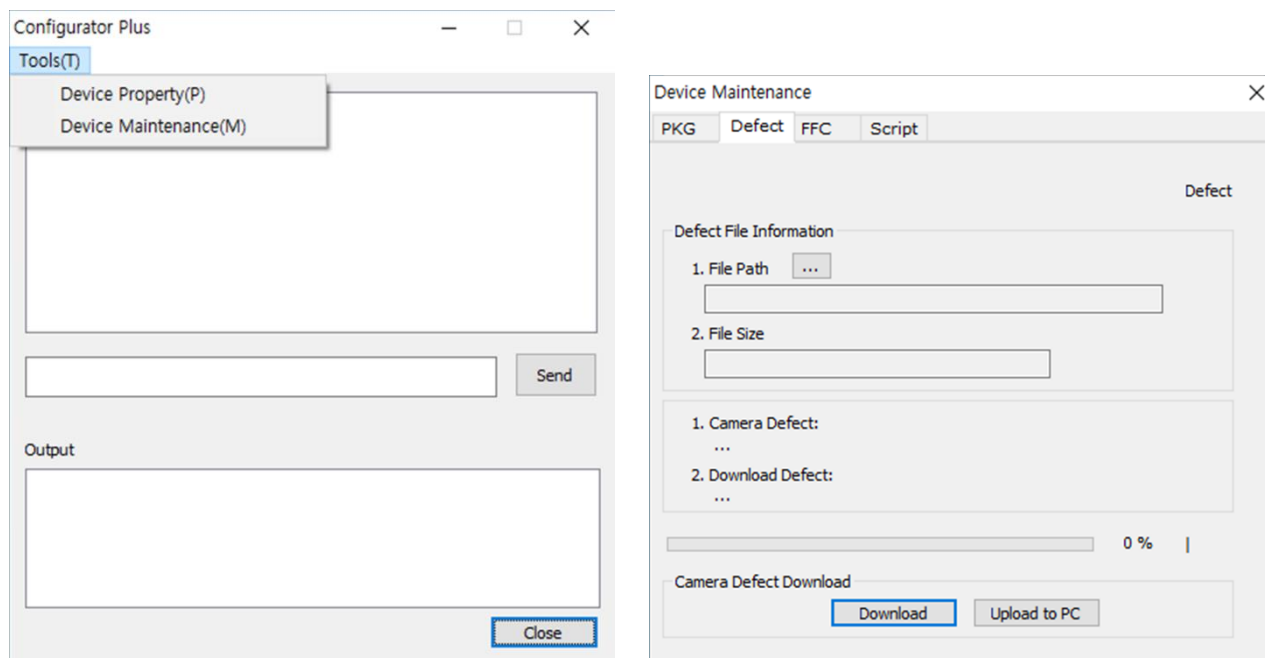

Figure 10.4 Configurator Plus and Device Maintenance

10.4 Command List

You can also set all features provided by VP-31MC-26 H camera by using the following commands.

Command	Syntax	Return Value	Description
Help	help	String	Displays a list of all commands.
Set ROI Offset X	sox n	OK	X coordinate of start point ROI
Get ROI Offset X	gox	n	n: X axis offset
Set ROI Offset Y	soy n	OK	Y coordinate of start point ROI
Get ROI Offset Y	goy	n	n: Y axis offset
Set Image Width	siw n	OK	Sets a width of the Image ROI.
Get Image Width	giw	n	n: Width value
Set Image Height	sih n	OK	Sets a height of the Image ROI.
Get Image Height	gih	n	n: Height value
Set Region Selector	srs n	OK	Selects a ROI to set when setting the Multi-ROI.
Get Region Selector	grs	n	n: Index number of a ROI (0 – 7)
Set Region Mode	src 0 1	OK	Enables / Disables the selected ROI when setting the Multi-ROI.
Get Region Mode	grc	0 1	0: Disables the selected ROI. 1: Enables the selected ROI.
Set Region Offset X	srx n	OK	Sets a horizontal offset from the origin to the selected ROI when setting the Multi-ROI.
Get Region Offset X	grx	n	n: X axis offset
Set Region Offset Y	sry n	OK	Sets a vertical offset from the origin to the selected ROI when setting the Multi-ROI.
Get Region Offset Y	gry	n	n: Y axis offset
Set Region Width	srw n	OK	Sets a width for the selected ROI when setting the Multi-ROI.
Get Region Width	grw	n	n: Width value (Setting range: 16 – Max.)
Set Region Height	srh n	OK	Sets a height for the selected ROI when setting the Multi-ROI.
Get Region Height	grh	n	n: Height value (Setting range: 4 – Max.)

Table 10.1 Command List #1

Command	Syntax	Return Value	Description
Set Binning Selector Get Binning Selector	sbns 0 1 gbns	OK 0 1	Selects the Binning engine. 0: Sensor 1: Logic
Set Binning Horizontal Mode Get Binning Horizontal Mode	sbhm 0 1 gbhm	OK 0 1	Updated automatically according to the Binning Vertical Mode. 0: Sum 1: Average (Not available)
Set Binning Horizontal Get Binning Horizontal	sbh 1 2 gbh	OK 1 2	Updated automatically according to the Binning Vertical. 1 2: ×1, ×2
Set Binning Vertical Mode Get Binning Vertical Mode	sbvm 0 1 gbvm	OK 0 1	Sets the Binning Mode to apply to the Binning Vertical. 0: Sum 1: Average (Not available)
Set Binning Vertical Get Binning Vertical	sbv 1 2 gbv	OK 1 2	The number of vertical pixels to combine together. 1 2: ×1, ×2
Set Test Image Get Test Image	sti 0 1 2 3 16 gti	OK 0 1 2 3 16	Sets the Test Image. 0: Disables the Test Image feature. 1: Sets to Grey Horizontal Ramp. 2: Sets to Grey Diagonal Ramp. 3: Sets to Grey Diagonal Ramp Moving. 16: Sets to the Test Image provided by the image sensor.
Set Camera Link Tap Geometry Get Camera Link Tap Geometry	stg 2 4 8 10 gtg	OK 2 4 8 10	Sets the Camera Link Tap Geometry. 2: 1X2-1Y (2 Tap) 4: 1X4-1Y (4 Tap) 8: 1X8-1Y (8 Tap) 10: 1X10-1Y (10 Tap)
Set Camera Link Clock Selector Get Camera Link Clock Selector	sccs 0 1 gccs	OK 0 1	Sets the Camera Link Pixel Clock speed. 0: 85 MHz 1: 65 MHz

Table 10.2 Command List #2

Command	Syntax	Return Value	Description
Set Data Bit Get Data Bit	sdb 8 10 12 gdb	OK 8 10 12	Sets the Pixel Format. 8: 8 bit 10: 10 bit 12: 12 bit
Set Defect Correction Get Defect Correction	sdc 0 1 gdc	OK 0 1	Sets the Defect Pixel Correction. 0: Disables the Defect Pixel Correction. 1: Enables the Defect Pixel Correction.
Set Horizontal Flip Get Horizontal Flip	shf 0 1 ghf	OK 0 1	Sets the Reverse X (Horizontal Flip). 0: Disables the Reverse X. 1: Enables the Reverse X.
Set Vertical Flip Get Vertical Flip	svf 0 1 gvf	OK 0 1	Sets the Reverse Y (Vertical Flip). 0: Disables the Reverse Y. 1: Enables the Reverse Y.
Acquisition Start	ast	OK	Starts image acquisitions.
Acquisition Stop	asp	OK	Stops image acquisitions.
Set Acquisition Mode Get Acquisition Mode	sam 0 1 2 gam	OK 0 1 2	Sets the Acquisition Mode. 0: Continuous 1: Single Frame 2: Multi-Frame
Set Acquisition Frame Count Get Acquisition Frame Count	safc n gafc	OK n	Sets the number of frames to be acquired when the Acquisition Mode is set to Multi-Frame. n: 1 – 255
Set Frame Rate Get Frame Rate	sfr n gfr	OK n	Sets the rate at which the exposure start trigger will be generated when the Trigger Mode is set to Off.
Get Acquisition Status	gast	0 1	Retrieves the internal acquisition status. 0: The camera is not in the process of acquiring a frame. 1: The camera is in the process of acquiring a frame.

Table 10.3 Command List #3

Command	Syntax	Return Value	Description
Set Trigger Mode Get Trigger Mode	stm 0 1 gtm	OK 0 1	Sets the Trigger Mode. 0: Trigger Mode Off (Free run mode) 1: Trigger Mode On
Set Trigger Source Get Trigger Source	sts 3 10 14 18 22 gts	OK 3 10 14 18 22	Specifies a source signal when the Trigger Mode is set to On. 3: Software 10: User Output0 14: CC1 18: Timer0 Active 22: Line0
Generate SW Trigger	nst	OK	Generates a Software trigger signal.
Set Trigger Activation Get Trigger Activation	sta 0 1 gta	OK 0 1	Sets the activation mode for the selected source signal when the Trigger Mode is set to On. 0: Falling Edge 1: Rising Edge
Set Exposure Mode Get Exposure Mode	sem/ses 0 1 gem/ges	OK 0 1	Sets the Exposure Mode. 0: Timed 1: Trigger Width
Set Short Exposure Mode Get Short Exposure Mode	ssem 0 1 2 gsem	OK 0 1 2	Sets the Short Exposure Mode. 0: Off (Normal Exposure Mode) 1: Super Short 2: Ultra Short
Set Exposure Time Get Exposure Time	set n get	OK n	Sets an exposure time. n: Exposure time in microseconds <ul style="list-style-type: none"> Normal Exposure Mode: 7.84 μs – 60s Super Short: 7.84 μs – 60 s Ultra Short: 2.37 μs – 32.27 μs
Get Exposure Offset	geo	n	Retrieves the current Exposure Offset. <ul style="list-style-type: none"> Normal Exposure Mode: 30.06 μs Super Short: 2.80 μs Ultra Short: 0.03 μs

Table 10.4 Command List #4

Command	Syntax	Return Value	Description
Set Black Level	sbl n	OK	Sets the black level value.
Get Black Level	gbl	n	n: Black Level (Setting range: 0 – 255)
Set Digital Gain	sdg n	OK	Sets the digital gain value.
Get Digital Gain	gdg	n	n: Gain (Setting range: 1× – 32×)
Generate PRNU Data	gpd	OK	Generates the PRNU data.
Set PRNU Data Selector	spds 0 1 2 3	OK	Selects a PRNU data location.
Get PRNU Data Selector	gpds	0 1 2 3	0: Default location 1 – 3: User-defined locations
Save PRNU Data	spd	OK	Saves the generated PRNU correction data in the selected PRNU data location.
Load PRNU Data	lpd	OK	Loads the PRNU data from the non-volatile memory into the volatile memory.
Generate Flat Field Data	gfd none 0 n	OK	Executes the Flat Field Generator. none / 0: Auto-adjusts the target value of the image after correction. n: Manually sets the target value of the image after correction (1 – 4095 @ 12 bit)
Set Flat Field Data Selector	sfds n	OK	Selects a Flat Field correction data location.
Get Flat Field Data Selector	gfds	n	n: 0 – 23 (User-defined locations)
Save Flat Field Data	sfd	OK	Saves the generated Flat Field correction data in the selected FFC data location.
Load Flat Field Data	lfd	OK	Loads the FFC data from the non-volatile memory into the volatile memory.
Set Flat Field Correction	sfc 0 1	OK	Sets the Flat Field Correction feature.
Get Flat Field Correction	gfc	0 1	0: Disables the Flat Field Correction. 1: Enables the Flat Field Correction.
Set Fan Mode	sfm 0 1	OK	Sets the Fan operation mode.
Get Fan Mode	gfm	0 1	0: Fan Off 1: Fan On
Set Peltier Operation Mode	sptm 0 1	OK	Sets the Peltier operation mode.
Get Peltier Operation Mode	gptm	0 1	0: Peltier Off 1: Peltier On

Table 10.5 Command List #5

Command	Syntax	Return Value	Description
Set Target Temperature Get Target Temperature	stt n gtt	OK n	Sets the temperature to operate the Peltier when the Peltier Operation Mode is set to On (n: -10°C – 80°C).
Get Fan RPM	gfrpm	String	Displays the Fan RPM.
Set Sequencer Mode Get Sequencer Mode	ssqm 0 1 gsqm	OK 0 1	Sets the Sequencer Mode. 0: Disables the Sequencer Mode. 1: Enables the Sequencer Mode.
Set Sequencer Config. Mode Get Sequencer Config. Mode	ssqcm 0 1 gsqcm	OK 0 1	Sets the Sequencer Configuration Mode. 0: Disables the Sequencer Config. Mode. 1: Enables the Sequencer Config. Mode.
Set Sequencer Set Selector Get Sequencer Set Selector	ssqss n gsqss	OK n	Selects an index number of a Sequencer Set to be configured. n: Sequencer Set index number (0 – 31)
Set Sequencer Set Count Get Sequencer Set Count	ssqsc n gsqsc	OK n	Sets the number of Sequencer Sets to be applied (n: 1 – 32).
Get Sequencer Set Active	gsqsa	n	Displays the index number of the Sequencer Set that is currently active (n: 0 – 31).
Reset Sequencer	rsq	OK	Returns to Sequencer Set 0.
Set Frame Averaging Mode Get Frame Averaging Mode	sfam 0 1 2 gfam	OK 0 1 2	Sets the Frame Averaging Mode. 0: Off 1: Average 2: Sum
Set Frame Averaging Count Get Frame Averaging Count	sfac n gfac	OK n	Sets the number of frames to be used for the Frame Averaging feature (n: 2 – 16).
Reset Frame Averaging	rfa	OK	Resets the Frame Averaging feature and starts it again.
Get Frame Averaging Status	gfas	0 1 2	Displays the status of the Frame Averaging. 0: Disabled 1: Idle 2: Busy
Get Frame Averaging Current Count	gfacc	n	Displays the number of frames that have been used for the Frame Averaging feature. n: 2 – 16

Table 10.6 Command List #6

Command	Syntax	Return Value	Description
Set Line Selector Get Line Selector	slns 0 1 glns	OK 0 1	Selects a physical line of the Control I/O receptacle to configure. 0: Line0 1: Line1
Get Line Mode	glnm	0 1	Retrieves the mode of the selected physical line. 0: Input 1: Output
Set Line Source Get Line Source	slnc 0 4 6 10 18 glnc	OK 0 4 6 10 18	Specifies a source signal for the Control I/O receptacle. 0: Off 4: Frame Active 6: Exposure Active 10: User Output0 18: Timer0 Active
Set Line Inverter Get Line Inverter	slni 0 1 glni	OK 0 1	Sets whether to invert the line output. 0: Disables inversion on the line output. 1: Enables inversion on the line output.
Set User Output Value Get User Output Value	suov 0 1 guov	OK 0 1	Sets the User Output value. 0: Sets the bit state of the line to Low. 1: Sets the bit state of the line to High.
Set Debounce Time Get Debounce Time	sdbt n gdbt	OK n	Sets the Debounce time n: Debounce time in microseconds (0 – 1,000,000 μ s)
Set Timer Duration Get Timer Duration	stdu n gtdu	OK n	Sets the duration of the Timer output signal. n: 1 – 60,000,000 μ s
Set Timer Delay Get Timer Delay	stdl n gtdl	OK n	Sets the delay time for the Timer. n: 0 – 60,000,000 μ s
Reset Timer	rtmr	OK	Resets the Timer and starts it again.
Get Timer Status	gtst	0 1 2	Displays the status of the Timer. 0: Timer Idle 1: Timer Trigger Wait 2: Timer Active

Table 10.7 Command List #7

Command	Syntax	Return Value	Description
Set Timer Trigger Source Get Timer Trigger Source	stts 0 4 6 22 gtts	OK 0 4 6 22	Specifies a source signal for the Timer output signal. 0: Off 4: Frame Active 6: Exposure Active 22: Line0
Set Timer Trigger Activation Get Timer Trigger Activation	stta 0 1 2 3 gtta	OK 0 1 2 3	Sets the activation mode for the Timer. 0: Falling Edge 1: Rising Edge 2: Level Low 3: Level High
Set AWB Offset X Get AWB Offset X	swx n gwx	OK n	Sets a horizontal offset from the origin to the Data ROI.
Set AWB Offset Y Get AWB Offset Y	swy n gwy	OK n	Sets a vertical offset from the origin to the Data ROI.
Set AWB Width Get AWB Width	sww n gww	OK n	Sets a width for the Data ROI.
Set AWB Height Get AWB Height	swh n gwh	OK n	Sets a height for the Data ROI.
Set RGB Gain Get RGB Gain	srg r g b n grg r g b	OK n	Sets the intensity of color pixels. r g b: Red / Green / Blue pixels n: Gain value (1.0× ~ 4.0×)
Auto White Balance	arg	OK	Automatically adjusts the white balance once.
Get Model Name	gmn	String	Displays the camera model name.
Get MCU Version	gmv	String	Displays the version of the camera MCU.
Get FPGA Version	gfv	String	Displays the version of the camera FPGA.
Get Serial Number	gsn piece	String	Displays the serial number of the camera.
Get Current Temperature	gct	String	Displays the device temperature in Celsius.
Reset Hardware	rst	-	Resets the camera physically to power off and on.

Table 10.8 Command List #8

Command	Syntax	Return Value	Description
Load Config. From	lcf 0 1 2	OK	Loads the camera setting values. 0: Loads the Factory Default Setting. 1: Loads the User 1 Setting. 2: Loads the User 2 Setting.
Save Config. To	sct 1 2	OK	Saves the current camera setting values. 1: Saves to the User 1 Setting. 2: Saves to the User 2 Setting.
Set Config. Initialization Get Config. Initialization	sci 0 1 2 gci	OK 0 1 2	Specifies setting values to be loaded when reset. 0: Factory Default Setting 1: User 1 Setting 2: User 2 Setting

Table 10.9 Command List #9

11 Troubleshooting

When you have a problem with a Vieworks camera, please check the following:

- If no image is displayed on your computer,
 - Ensure that all cable connections are secure.
 - Ensure that the power supply is properly connected.
 - Ensure that trigger signals are applied correctly when you operate the camera with trigger signals.
- If images are not clear,
 - Ensure the camera lens or glass is clean.
 - Check the lens aperture is adjusted properly.
- If images are dark,
 - Ensure the camera lens is not blocked.
 - Check the exposure time is set properly.
 - Check the aperture is opened properly.
 - Check the Gain value is not set to small.
- If you identify abnormal operation or overheating sign,
 - Ensure the power supply is properly connected.
 - Stop using the camera when you notice smoke or abnormal overheating.
- If you have a problem using the Trigger Mode,
 - Ensure that the Software related settings are configured correctly.
 - Ensure that CC1 settings on your frame grabber are configured correctly when you operate the camera with CC1 trigger signals.
 - Ensure that cable connections are secure when you operate the camera with external trigger signals.
- If there is a communication failure between the camera and user's computer,
 - Ensure that the Camera Link cable connections are secure.
 - Ensure that you have configured a frame grabber in your computer and the camera is connected to the frame grabber correctly.

Appendix A Defective Pixel Map Download

1. Create a Defective Pixel Map in Microsoft Excel format as shown in the left figure below and save as CSV file (*.csv). The figure in the right shows the created Excel file opened with Notepad. The following rules need to be applied when creating the file.
 - Lines beginning with ':' or '--' are treated as notes.
 - You must enter the horizontal value first and then the vertical value for the coordinate of each defect pixel.
 - Coordinate values for each pixel can be placed in any order.

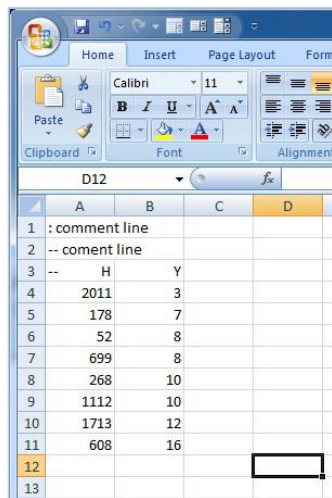

The screenshot shows a Microsoft Excel spreadsheet with the following data:

	A	B	C	D
1	:	comment line		
2	--	comment line		
3	--	H	Y	
4		2011	3	
5		178	7	
6		52	8	
7		699	8	
8		268	10	
9		1112	10	
10		1713	12	
11		608	16	
12				
13				

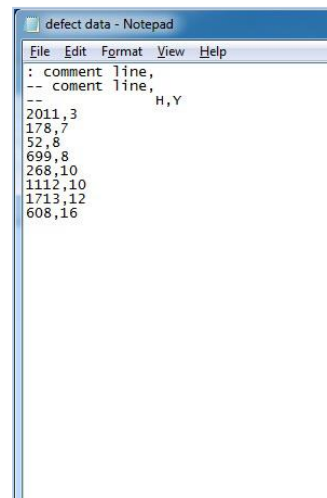

```
defect data - Notepad
File Edit Format View Help
: comment line,
-- comment line,
--
2011,3
178,7
52,8
699,8
268,10
1112,10
1713,12
608,16
```

2. Run the Configurator and then click **Configurator Plus > Tools > Device Maintenance** to open the **Device Maintenance** window.
3. Select the **Defect** tab, click the **File Path** button, select the defective pixel map (*.csv), and then click the **Download** button.

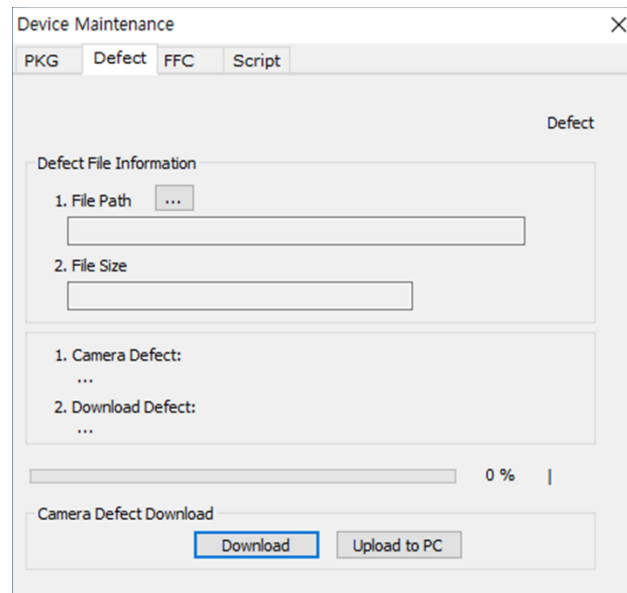

4. Once the download is complete, the saving process will begin. During the saving process, make sure not to disconnect the power cord.
5. After completing the download, click the **OK** button to close the confirmation.

Appendix B Field Upgrade

You can upgrade the MCU, FPGA and XML file of the camera by following the procedure below.

1. Run the Configurator and then click **Configurator Plus > Tools > Device Maintenance** to open the **Device Maintenance** window.
2. Select the **PKG** tab, click the **File Path** button, select the MCU, FPGA or XML upgrade file, and then click the **Download** button.

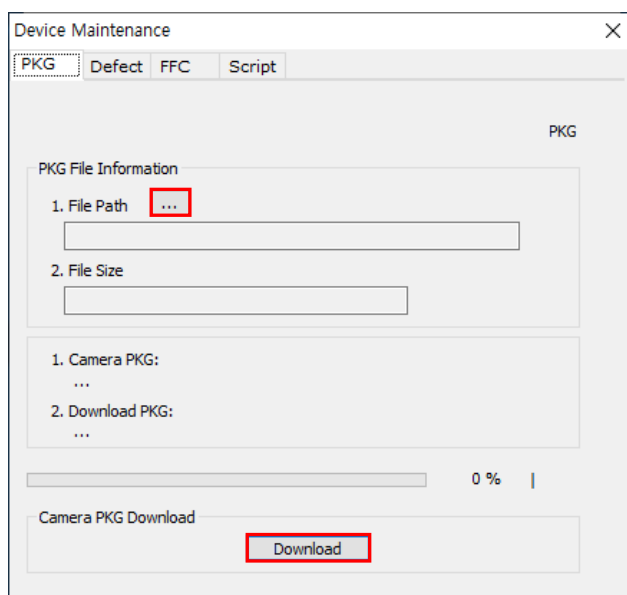

3. The camera begins downloading the upgrade file and the downloading status is displayed at the bottom of the window.
4. After completing the download, click the **OK** button to close the confirmation.

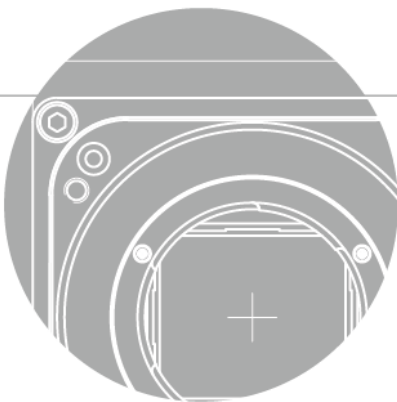
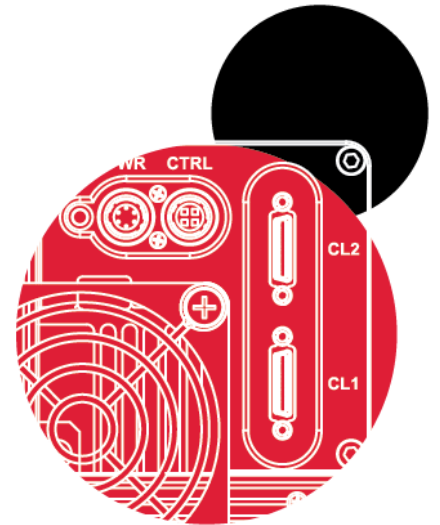
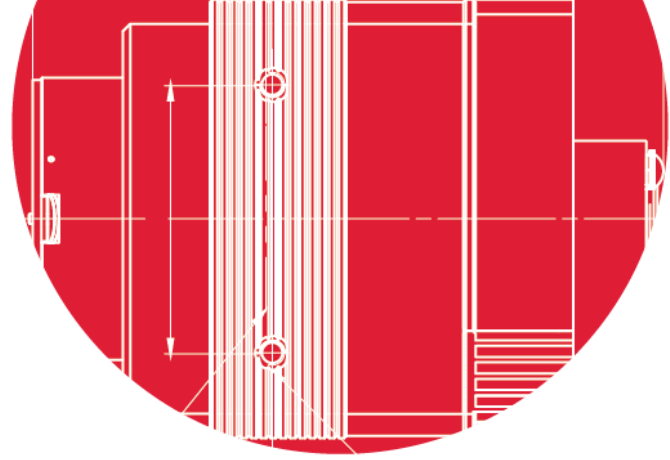

Vieworks Co., Ltd.

41-3, Burim-ro, 170beon-gil,
Dongan-gu, Anyang-si, Gyeonggi-do
14055 Republic of Korea

Tel: +82-70-7011-6161

Fax: +82-31-386-8631

<http://www.vieworks.com>

vision@vieworks.com