

user manual

pc_o.edge 26



pc_o.

An Excelitas Technologies Brand

PCO asks you to carefully read and follow the instructions in this manual before using the pco.edge camera system.

For any questions or comments, contact us at PCO.



telephone	+49 (0) 9441 2005 50
fax	+49 (0) 9441 2005 20
email	info@pco.de
postal address	Excelitas PCO GmbH Donaupark 11 93309 Kelheim, Germany

The cover photo shows a real-world use of a PCO camera system.
The lens is sold separately.

Released: July 2022 © Excelitas PCO GmbH

pco.edge 26 User Manual V1.01 © Excelitas PCO GmbH, Germany



This work is licensed under the Creative Commons Attribution-NonCommercial 4.0 International License. To view a copy of this license, visit <http://creativecommons.org/licenses/by-nc/4.0/> or send a letter to Creative Commons, PO Box 1866, Mountain View, CA 94042, USA.

TABLE OF CONTENTS

1. INTRODUCTION	4
1.1 INTENDED USE	4
1.2 CONVENTIONS	4
2. SAFETY INSTRUCTIONS	5
3. SYSTEM COMPONENTS	6
4. INSTALLATION	8
4.1 DRIVER	8
4.2 CAMWARE SOFTWARE	9
5. QUICK START	10
5.1 PREPARATION	10
5.2 START	10
5.3 FIRST IMAGE	11
6. GLOBAL SHUTTER	12
7. CAMWARE 4 SOFTWARE	14
7.1 HARDWARE IO CONTROL	14
APPENDIX	16
A1 TECHNICAL DATA	17
A1.1 DATA SHEET	17
A1.2 MECHANICAL DIMENSIONS	18
A1.3 REAR PANEL	19
A2 HARDWARE MOUNTING	20
A2.1 USB CARD INSTALLATION	20
A2.2 CABLE MOUNTING	21
A3 F-MOUNT ADAPTER	22
A3.1 PCO F-MOUNT ADAPTER	22
A3.2 CHANGE FROM F-MOUNT TO C-MOUNT	23
A4 WATER COOLING OPTION PCO.AQUAMATIC II	24
A4.1 SYSTEM COMPONENTS	24
A4.2 FIRST TIME INSTALLATION	25
A4.3 OPERATION	26
A4.4 DIMENSIONS	27
A4.5 USING YOUR OWN COOLING SYSTEM	27
A5 CUSTOMER SERVICE	28
A5.1 SERVICE	28
A5.2 MAINTENANCE	28
A5.3 RECYCLING	28
A5.4 TROUBLESHOOTING	29
A6 INDEX	30
ABOUT PCO	31

1. INTRODUCTION



The pco.edge 26

Welcome to the pco.edge 26 system. This manual should help you to familiarize yourself with the camera and its functions. If you have any questions, please contact PCO directly.

Main Features

- True charge domain global shutter
- Ultra high resolution: 5120 x 5120 pixel
- Exposure time: 5 μ s ... 60 s
- Pixel size (h x v): 2.5 μ m x 2.5 μ m
- Dynamic range 66 db
- Compact design
- Adjustable: from - 20 °C to + 20 °C peltier with forced air (fan) and water cooling
- Up to 72 % quantum efficiency
- USB 3.1 Gen 1 data interface

1.1 INTENDED USE

This camera system is designed for use by technicians, engineers and scientists. It is a scientific measuring instrument, which also provides images.

The camera may only be used according to the instructions of this manual. Operator agrees to respect the disclosures and operating conditions in these operating instructions. To ensure safe use, unauthorized modifications and changes to the device are forbidden.

1.2 CONVENTIONS

The following typographic conventions are used in this manual:

<i>bold italics</i>	Terms that can be found in the software pco.camware
Features	Heading within a chapter
A1.3	Bold chapter: hyperlink to a chapter
1 1	Numbers direct to corresponding function
NOTE	Notes that must be observed

2. SAFETY INSTRUCTIONS



DANGER

Read the safety instructions completely. Failure to follow them can result in injury or death.

DAMAGED POWER CABLE OR POWER PLUG

Mortal danger due to electric shock.

- Check the power cable for damage each time the camera is used.



WARNING

ELECTRIC SHOCK WARNING DUE TO VOLTAGE PARTS INSIDE

Risk of injury due to electric shock.

- Never slide any items through slits or holes into the camera.



CAUTION

MOISTURE

Risk of injury due to electric shock if moisture enters the camera.

- To avoid the risk of water condensation, protect the camera against extreme changes of ambient temperature.



CAUTION

TRIPPING HAZARD

Risk of injury from tripping over loose cables.

- Never position the cable in such a way as to become a tripping hazard.

NOTICE

HUMIDITY, DUST OR RADIATION

Humidity, dust or X-rays can damage the camera.

- Never operate the camera in humid or dusty environments or in places with high levels of x-ray radiation.

NOTICE

VIBRATION

Camera must be firmly mounted and protected against strong shocks or vibrations to avoid damage.

- Use the camera's mounting threads to secure it.

NOTICE

LENS MOUNTING

Screw in the lens gently to avoid thread damage.

- Use minimal force when attaching a lens to the camera to protect the lens connector thread from damage.

NOTICE

LIQUIDS DAMAGE CAMERA

If liquids have penetrated the device:

- Switch the camera off immediately, detach it from power and contact PCO's customer support.

NOTICE

DAMAGED CAMERA HOUSING

If the camera has been dropped or the camera body is damaged:

- Switch the camera off immediately, detach it from power and contact PCO's customer support.

NOTICE

IF CAMERA IS NOT WORKING PROPERLY

If the troubleshooting steps in this manual are unsuccessful:

- Switch the camera off immediately, detach it from power and contact PCO's customer support.

3. SYSTEM COMPONENTS

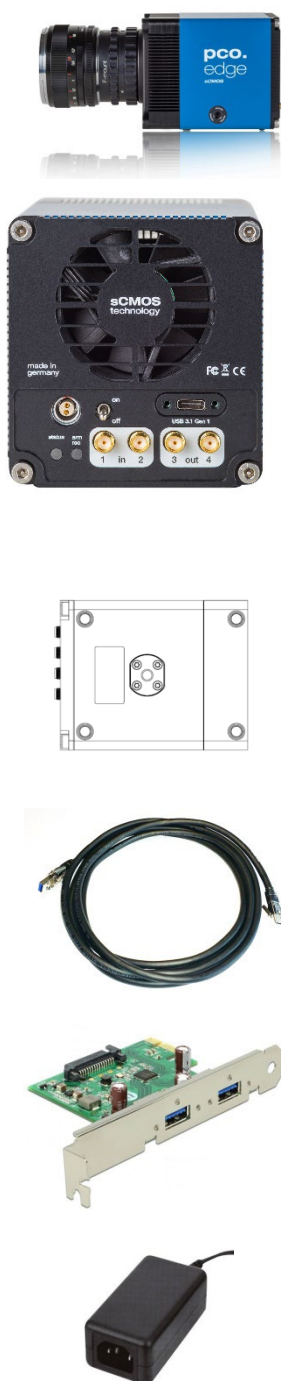

The camera system includes the following parts.

Camera

- F-mount / C-mount optical connection
- For standard C-mount / F-mount lenses and adapters

Rear Panel

- USB 3.1 Type C connector
- LED indicates camera status (see **A1.3**)
- SMA connectors
- Power connector

Serial Number Tag

Mounting Thread

- 1x 1/4"- 20 UNC

USB 3.1 Cable

- USB Type A / USB Type C screwable cable
- Length 3 m

USB 3.0 / 3.1 Gen1 Interface Card

- 2x USB Type A socket
- PCI Express x1 V2.0

Power Supply & Power Cord

- Output: 24 VDC / 36W / 1.5A
- Connector: Lemo FGG.0B
- Voltage input: 115 VAC - 230 VAC; IEC 60320 C14 plug
- Power cord IEC 60320 C13



Digital Camera Tools (USB flash drive content)

- pco.camware: software for camera control & image acquisition
- Camera driver & tools
- Software Development Kit (SDK) & demo programs in C and C++

4. INSTALLATION

All necessary files can be found on the accompanying USB flash drive. You may also download the latest versions of our software, camera driver and third party software drivers from our Website (www.pco.de).

Minimum system requirements:

- Intel® Core™ i7
- RAM > 8 GB DDR3
- Windows 7 or higher
- Full-HD resolution display
- USB 3.1 Gen1

4.1 DRIVER

Install PCO USB 3.0/3.1 Driver

Always install the latest USB driver version. Install the driver from screen **1**. You will see screen **2** after the driver is successfully installed.

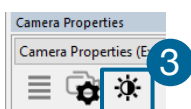
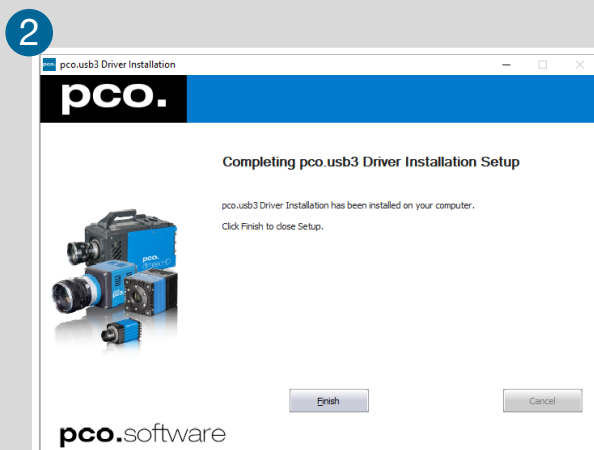
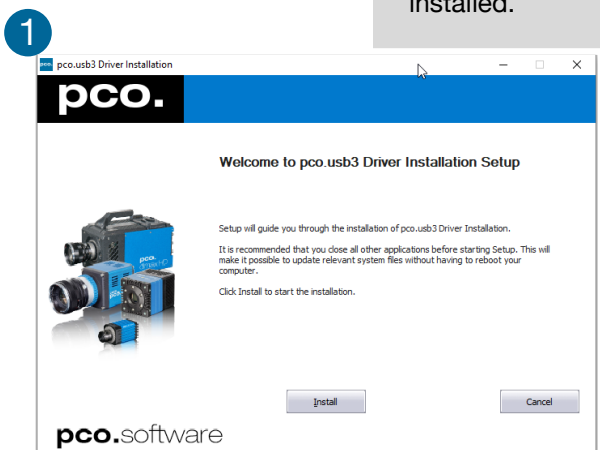

NVIDIA Cuda Driver

This is only relevant if an NVIDIA graphics card is used! **GPU Processing** only functions with NVIDIA graphics cards.

Update your NVIDIA driver for pco.camware. If an old driver version is installed, **GPU Processing** will not function, and image processing will be slow.

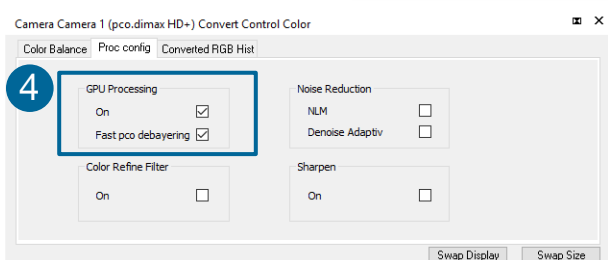

Check if **GPU Processing** is activated from the **Proc config** settings **4** in the **Convert Control** window **3** (see pco.camware manual).

If **GPU Processing** is disabled and greyed out, update your NVIDIA driver.

4.2 CAMWARE SOFTWARE

The pco.camware software controls every camera parameter or setting. Images can be displayed on a monitor and may be downloaded and stored. The USB flash drive contains the installation files for Windows operating systems in 32 & 64 bit.

After a successful installation, you will find the program file Digital Camera Toolbox in your program directory and a pco.camware 32 / 64 button on your desktop.

To uninstall the pco.camware program, navigate to Windows' Add or remove programs from system settings.

Follow the Installation Wizard

- 1 **Install as admin** to install to program folder, otherwise it is installed only to user folder
- 2 Choose install directory
- 3 Choose components: select additional drivers (not recommended for pco.edge 26) and select **Install**
- 4 Installation is complete

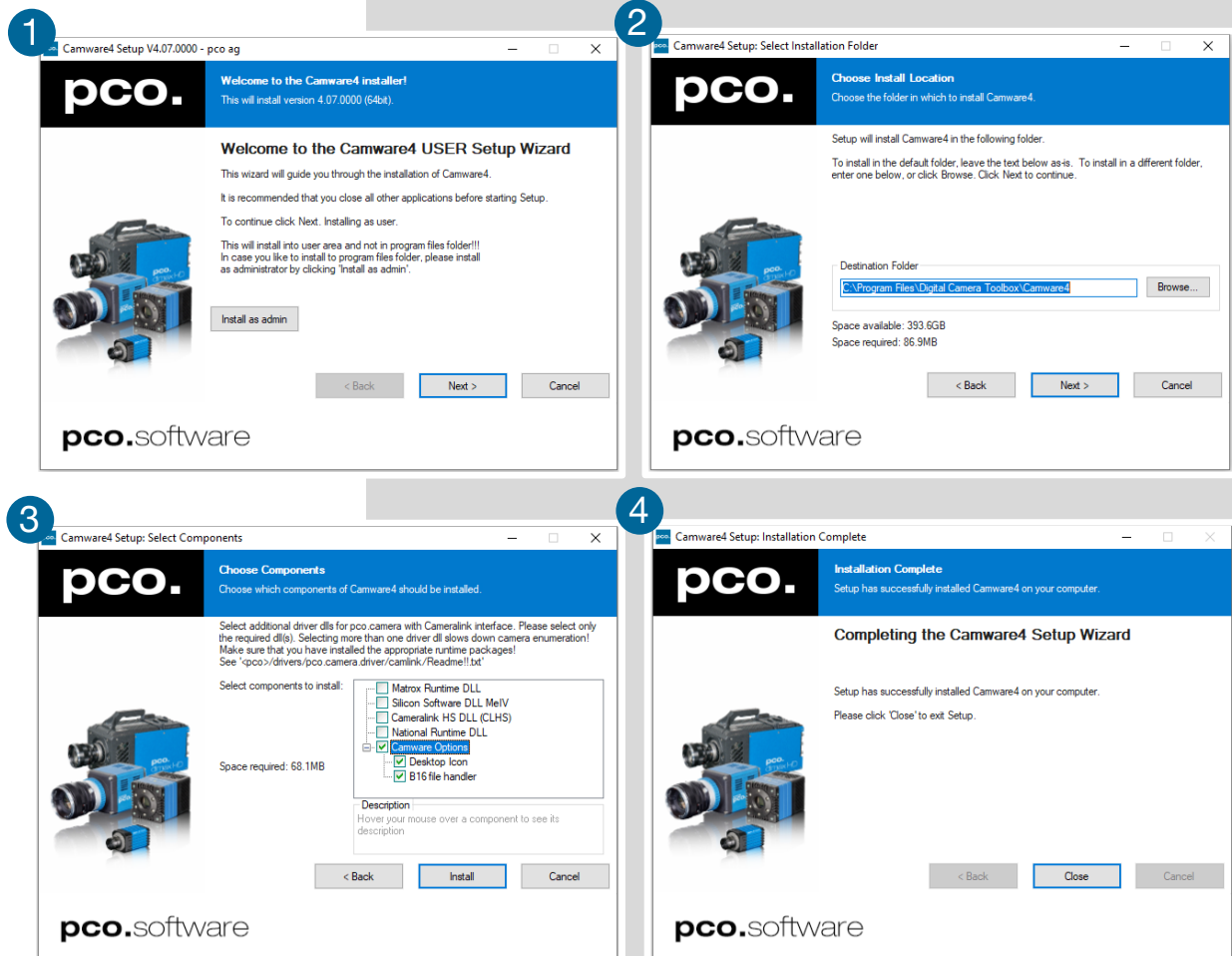

5. QUICK START

To familiarize yourself with your new camera and software it might be helpful to first aim at an object that is easy to focus on and that can be seen in standard light conditions.

5.1 PREPARATION

Before beginning, ensure that:

- Computer is turned on
- Installation is finished (see chapter 4)
- An appropriate lens is attached (remove cap) or the camera is attached properly to the microscope, spectrograph or other scientific device
- Camera is connected to the PC

5.2 START



Start pco.camware to begin working with the graphical user interface:



NOTE

Always install the latest version of pco.camware to access full function of your camera (www.pco.de/support).

5.3 FIRST IMAGE

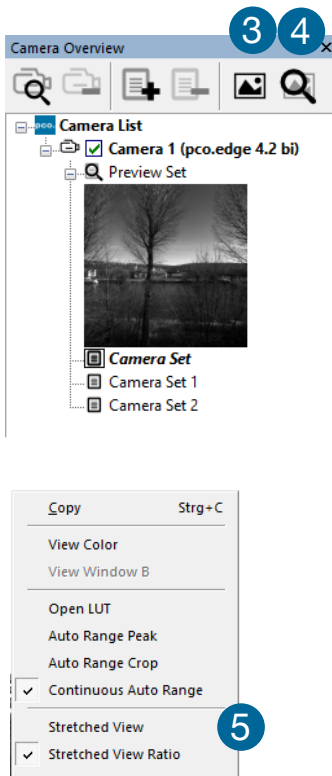

Follow the Instructions



- Start pco.camware ①
- A **View Window** ② is shown automatically or open a new one ③
- Start **Live Preview** ④
- Right-click in the view window & apply **Continuous Auto Range** ⑤
- You may adjust **Exposure** time ⑥, aperture and focus of the mounted lens
- You should clearly see the object in the window ⑦

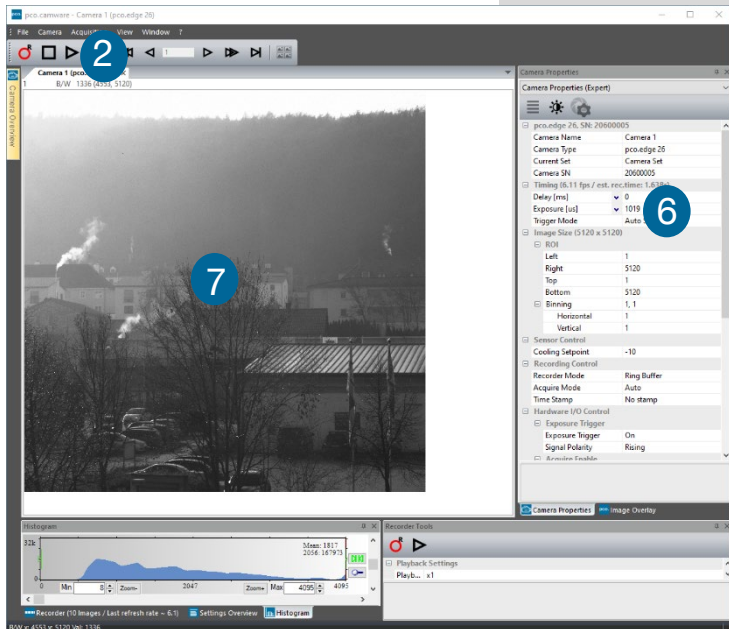

To change **Exposure** time (e.g., the image is still either too dark or too bright) and to record and save images, see pco.camware manual for detailed information.

NOTE

Live preview: useful for fast and easy camera adjustment and focusing.

6. GLOBAL SHUTTER

The pco.edge 26 uses the global shutter mode for image acquisition.

First, all pixels are globally reset and its reset values are stored internally on the sensor. The image exposure starts. After exposure and readout, the sensor completes the correlated double sampling (CDS). During the readout phase, a new exposure can start.

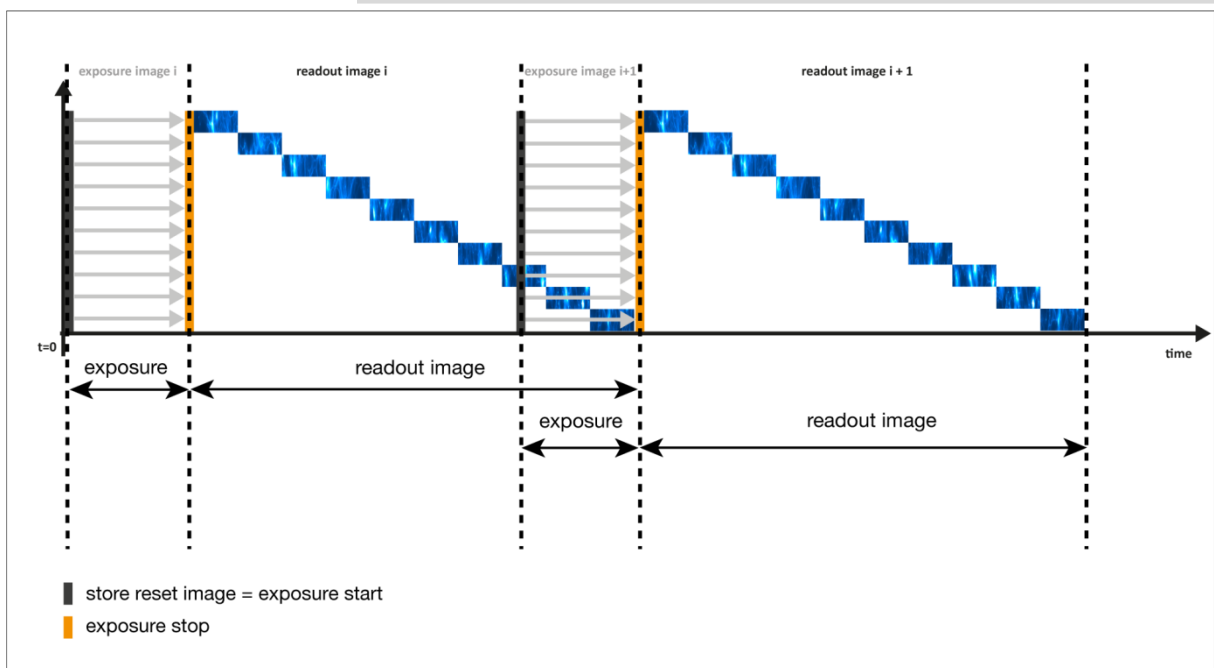

Timing

The exposure and delay time can be adjusted in a step size of 30 μs .

Camera	Exposure time	Delay time
pco.edge 26	20 μs ... 60 ms	0 μs ... 1 s

Global Shutter GMAX0505 (exposure time < readout time)

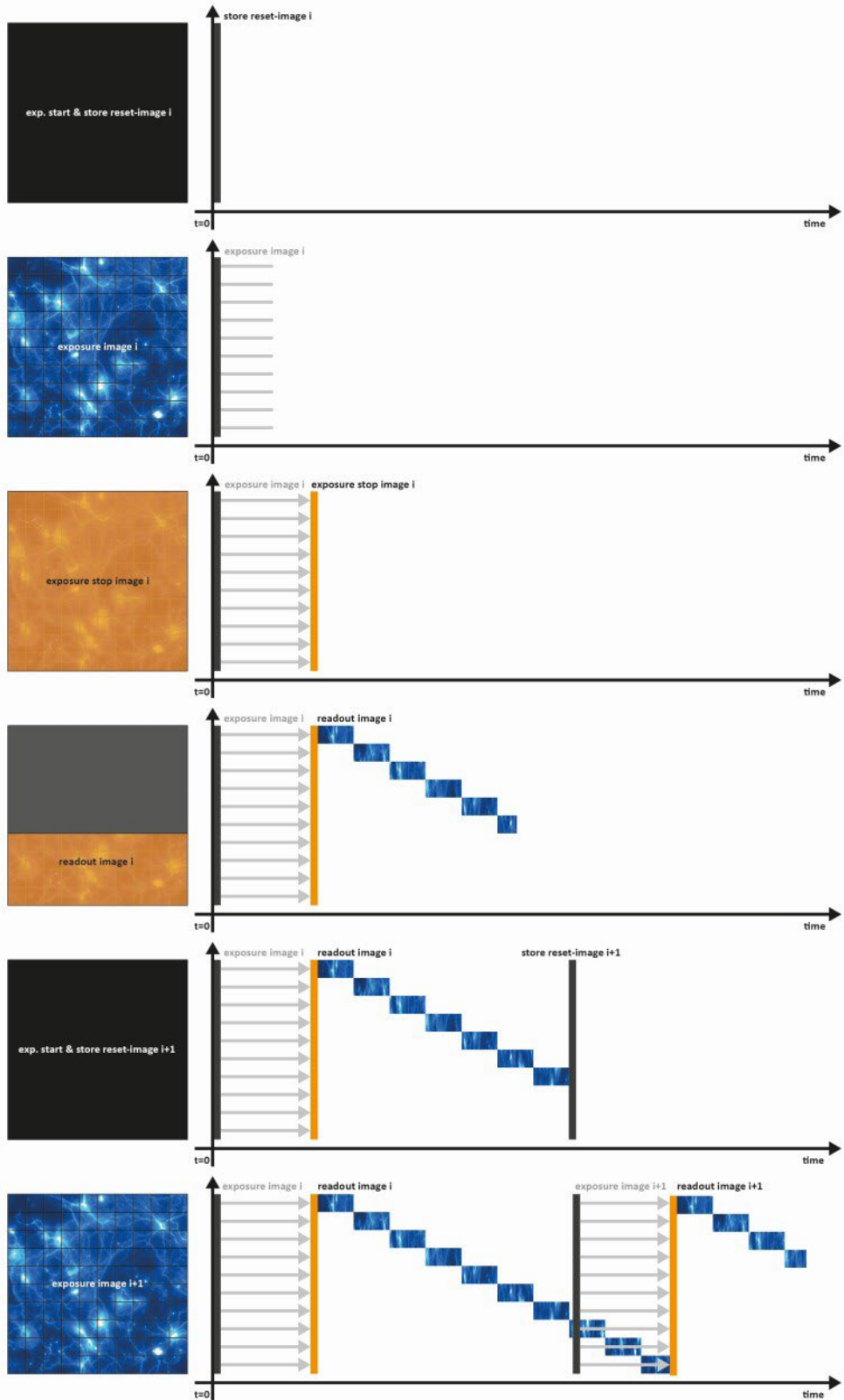

7. CAMWARE 4 SOFTWARE

This chapter contains only camera-specific additions to the pco.camware manual. All main functions and explanations can be found in the pco.camware manual.

7.1 HARDWARE IO CONTROL

Hardware IO Control	
Exposure Trigger	
1	Exposure Trigger On
	Signal Polarity Rising
Acquire Enable	
2	Acquire Enable On
	Signal Polarity High
Status Busy	
3	Status Busy On
	Signal Polarity High
Status Expos	
4	Select IO Signal Status Expos
	Signal Timing Show time of 'Last Line'
	Status Expos On
	Signal Polarity High

Settings can be changed with a drop-down menu.

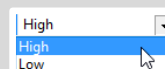

Exposure Trigger 1

If **On**, a signal for **External Exposure Start Trigger Mode** is accepted at the **Exposure Trigger** SMA input #1.

Exposure Trigger: On; Off
Signal Polarity: Rising; Falling

Acquire Enable 2

If **On**, a signal for **Acquire Mode** is accepted at the **Acquire Enable** SMA input #2.

Acquire Enable: On; Off
Signal Polarity: High; Low

Status Busy 3

If **On**, a signal indicating busy status is provided at the **Status Busy** output. Once an acceptable trigger edge is received, 'busy' goes to status high. As soon as 'busy' goes low again, a new trigger edge is accepted.

Status Busy: On; Off
Signal Polarity: High; Low

Status Expos 4

If **On**, a signal indicating exposure or line status is given at the status output. **Status Expos** indicates the actual exposure window for one frame.

Select IO Signal: Status Expos;
Signal timing: Show time of 'First Line'; Show common time of 'All lines'; Show time of 'Last line'; Show overall time of 'All lines'
Status Expos: On; Off
Signal Polarity: High; Low



Enabling and Polarity of IO Signals

The polarity of the input and output signals indicating their active states is selectable (positive or negative logic).

The polarity of level-sensitive signals can be set to **High** (positive logic) or **Low** (negative logic).

The polarity of edge-sensitive signals can be set to **Rising** (positive logic) or **Falling** (negative logic).

APPENDIX

A1 TECHNICAL DATA	16
A1.1 DATA SHEET	17
A1.2 QUANTUM EFFICIENCY CURVE	17
A1.3 MECHANICAL DIMENSIONS	18
A2 HARDWARE MOUNTING	19
A2.1 USB CARD INSTALLATION	19
A2.2 MOUNTING OF THE PCO.EDGE 26	21
A3 F-MOUNT ADAPTER	22
A3.1 PCO F-MOUNT ADAPTER	22
A3.2 CHANGE FROM C-MOUNT TO F-MOUNT	23
A4 WATER COOLING OPTION PCO.AQUAMATIC II	24
A4.1 SYSTEM COMPONENTS	24
A4.2 FIRST TIME INSTALLATION	25
A4.3 OPERATION	26
A4.4 DIMENSIONS	27
A4.5 YOUR OWN COOLING SYSTEM	27
A5 CUSTOMER SERVICE	28
A5.1 SERVICE	28
A5.2 MAINTENANCE	28
A5.3 RECYCLING	28
A5.4 TROUBLESHOOTING	29
A6 INDEX	29
ABOUT PCO	31

A1 TECHNICAL DATA

A1.1 DATA SHEET

Image sensor	pco.edge 26
Type of sensor	customized sCMOS
Resolution (h x v)	5120 x 5120 pixel
Pixel size (h x v)	2.5 µm x 2.5 µm
Sensor format / diagonal	12.8 x 12.8 mm / 18.1 mm
Shutter mode	Global/Snapshot Shutter (GS)
MTF	200 lp/mm (theoretical)

Camera	
Frame rate	7.1 fps @ full resolution
Exposure / shutter time	5 µs ... 60 ms
Dynamic range A/D	12 bit
Binning (h x v)	1x1 ... 4x4
Cooling method	adjustable: from -20°C to +20°C peltier with forced air (fan) and water cooling. Calibration setpoint: -10°C
Trigger input signals	frame trigger, sequence trigger, programmable input (SMA connectors)
Trigger output signals	exposure, busy, programmable output (SMA connectors)
Data interface	USB 3.1 Gen1
Timestamp	in image (1 µs resolution)

General	
Power delivery	power over USB 3.1 Gen1 and power connector (24 VDC +/- 10%)
Power consumption	typ. 4.5 W over USB 3.1 Gen 1 and typ. 10.0 W (max. 22.0 W) overpower connector
Weight	970 g
Operating temperature	+10°C ... +40°C
Operating humidity range	10% ... 80% (non-condensing)
Storing temperature range	-10°C ... +60°C
Optical interface	F-mount, C-mount
CE / FCC certified	yes

ROI step sizes	
Horizontal steps	32 pixel steps
Vertical steps	8 pixel steps
Minimum ROI	64 x 16 pixels

Subject to change, refer to current data sheet available on our website.

A1.2 MECHANICAL DIMENSIONS

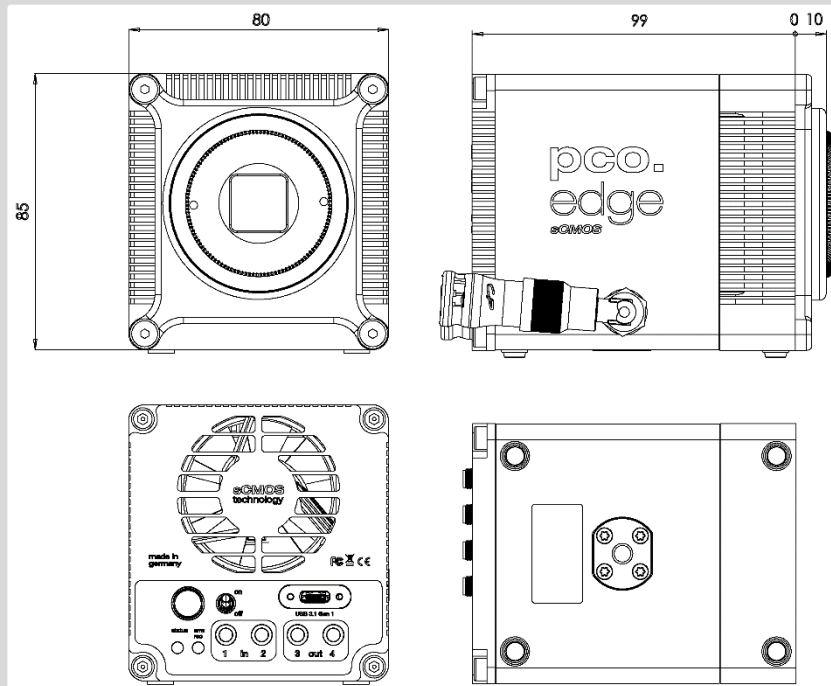

All dimensions are in millimeters.

2D and 3D technical drawings are available on our website.

3D step files and further technical drawings are available on request.

A1.3 REAR PANEL

**Status LEDs** ①

(LED1: green / red; LED 2: orange)

Color		Description
Red / green continuous		Camera is booting
Green		Camera is ready for operation
Orange continuous		Arm camera / rec state off
Orange blinking		Recording on
Red continuous		Error

Interface Connector ②

USB 3.1 plug Type-C (screwable)

SMA Inputs ③

(see chapter 7)

Input (1=Exposure Trigger; 2=Acquire Enable)	
Type	Digital
Level	3.3 V LVTTTL (5 V tolerant)
Coupling	DC
Impedance	1 kΩ
Slew rate	> 1 V/ms

SMA Outputs ④

(see chapter 7)

Output (3=Status Busy; 4=Status Expos)	
Type	Digital
Level	3.3 V LVTTTL
Coupling	DC
Load current	Max. 100 mA

Power Input ⑤

LEMO socket ECG.0B.302.CLV	
Pin1	VCC 24 V DC (+/- 10 %)
Pin2	Ground

Appropriate Lemo plug: FGG.0B.302.CLAD52Z

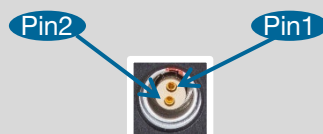
**Power Switch** ⑥

A2 HARDWARE MOUNTING

These instructions will show how to mount the pco.edge 26 camera system.

A2.1 USB CARD INSTALLATION

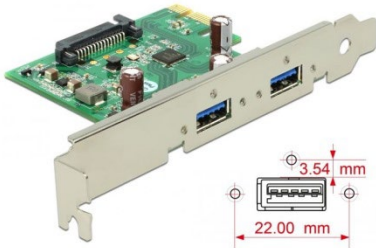

WARNING

NOTE

In multi-camera operation, each pco.edge 26 camera needs its own USB host controller card.

An external USB 3.0 / 3.1 Gen1 host controller card comes with each pco.edge 26 camera.

Hardware Installation

First shut down your computer and install the USB 3.0 / 3.1 Gen1 host controller card. Hardware installation must be performed by a technician, because high voltages can run through the device.

ELECTRIC SHOCK WARNING DUE TO VOLTAGE PARTS INSIDE

Risk of injury due to electrical shock.

→ Always pull the main plug before opening the computer.

Driver Installation Instructions

- Within the provided installation files USB_HBA, open the folder U3X4-PCIE4XE101, U3X4-PCIE1XE101, U3-PCIE1XG202.
- Open the subfolder Driver and run RENESAS-USB3-Host-Driver-30230-setup.exe.
- If your current OS is Win 7 / 8 and the User Account Control is enabled, a dialog prompts whether you wish to start the setup: accept with **Yes**.

- 1 System begins by preparing for installation.
- 2 The software components are copied automatically.
- 3 Installation is complete and the Delock USB 3.0 / 3.1 Gen1 extension card is ready for use.

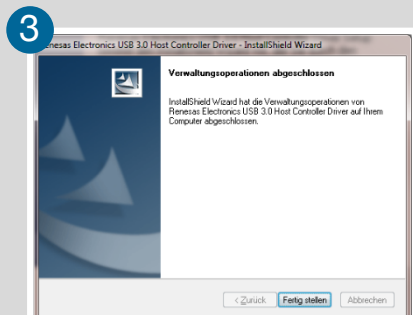
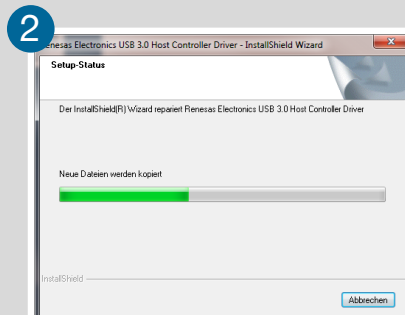
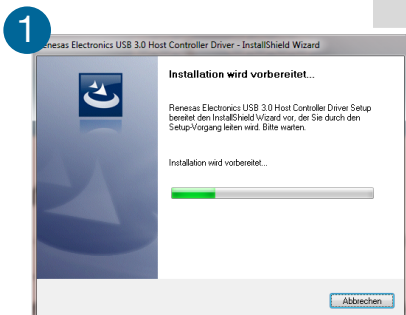

A2.2 CABLE MOUNTING



In order to ensure proper function of the pco.edge 26, it is necessary to secure the USB cable by the fixing screws.

The accompanying USB cable is screwable on both ends of the cable.



Screw Connection to the Camera (recommended)

- The screw threads of the camera are very sensitive due to the small size.
- Plug the USB cable into the camera.
- Then attach the fittings to the threads by hand.
- Use a small screwdriver to gently tighten the fittings.

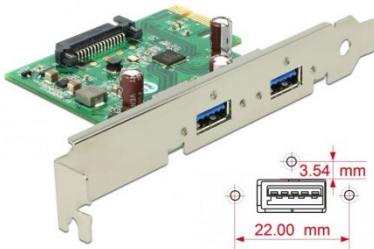

Screw Connection to the Computer (optional)

- Attach the cable to the USB card in the same way.



Power supply cable

- Provides power to the camera.

A3 F-MOUNT ADAPTER

A3.1 PCO F-MOUNT ADAPTER



When using PCO's proprietary F-mount adapter for lenses with automatic diaphragm, the aperture can be set manually by turning the ring on the adapter.

F-mount lenses without automatic diaphragm can also be fastened to the camera's mount but the aperture cannot be changed.



Adjust Back Focal Length

To adjust the back focal length (e.g., you cannot focus to infinity or to the minimum object distance of your lens), proceed as follows:

- Set the focus of your lens to infinity.
- Look at an object in infinity and generate a sharp image by turning the adapter.
- Use the rearmost ring to fix the setting.

Matching Lenses with Automatic Diaphragm

Nikon: all Nikkor lenses of type D and type G (not for type E, this one is only electronic).

Zeiss: all ZEISS ZF.2 lenses (Otus, Milvus, Interlock, Distagon, Planar).

Sigma: only lenses that already have a manual diaphragm ring. All other lenses have an aperture control lever, which does not spring back if you turn the aperture ring at the adapter.

Tamron: only some lenses provide automatic diaphragm (no particular lens family):

Type 35mm F-Mount

- A012: SP 15-30mm F/2.8 Di VC USD
- A007: SP 24-70mm F/2.8 Di VC USD
- A009: SP 70-200mm F/2.8 Di VC USD
- A011: SP 150-600mm F/5-6.3 Di VC USD
- F012: SP 35mm F/1.8 Di VC USD
- F013: SP 45mm F/1.8 Di VC USD
- F017: SP 90mm F/2.8 Di MACRO 1:1 VC USD

Type APS-C(H) F-Mount

- B001: SP AF 10-24mm F/3.5-4.5 Di II LD Aspherical [IF]
- B005: SP AF 17-50mm F/2.8 XR Di II VC LD Aspherical [IF]
- G005: SP AF 60mm F/2.0 Di II LD [IF] Macro 1:1

A3.2 CHANGE FROM F-MOUNT TO C-MOUNT

Instructions on how to change the optical input from F-mount to the enclosed C-mount adapter:

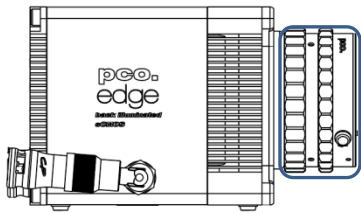

Step 1: Remove F-mount Adapter

Grasp the F-mount adapter at the black ring (counter ring) and turn it counter clockwise.

F-mount adapter

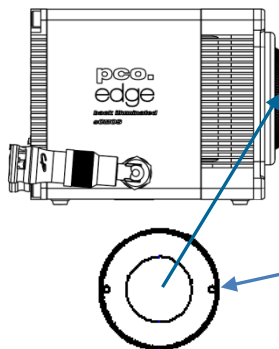

Step 2: Insert C-mount Adapter

Gently screw the ring completely in and tighten the two Hexagonal socket screws.

C-mount ring

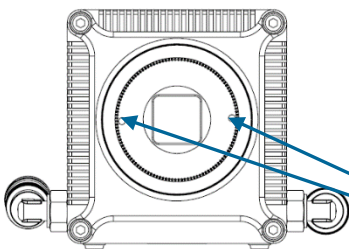

Step 3: Adjust Back Focal Length

First, attach a lens to your C-mount adapter. Then set the focus of your lens to infinity. Look at an object in infinity* and generate a sharp image by turning the smaller ring of the adapter. Then fix this position with the two small hexagonal socket screws.

*rule of thumb: object should be away about 2000 times the focal length in mm

hexagon socket screws



Limitations of C-mount Lenses

Keep in mind that C-mount lenses could cause shadings at the edges of large sized sensors. Most C-mount lenses are able to illuminate a maximum image circle of 11 mm (2/3"), 16 mm (1") or 22 mm (4/3") diameter only.

The pco.edge 26 has a sensor diagonal of 18.1 mm, therefore you have to use the ROI function for a shade-less image while using the C-mount adapter with the two smaller C-mount diameters.

A4 WATER COOLING OPTION PCO.AQUAMATIC II

This is the re-cooling system for pco.edge 26 cameras with water-cooling.

A4.1 SYSTEM COMPONENTS

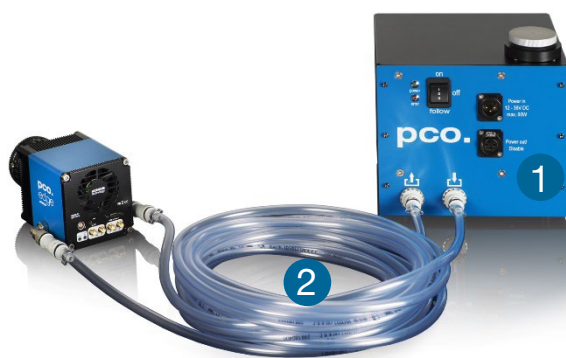

	Description
1	pco.aquamatic
2	connection tube 5m PVC 3541-01 PCO (Colder NS212 fittings)
3	power supply (1.2m cable length)
4	power cable
5	camera cable 5m (FGG-RG58-NC3MX)
6	Innovatec Protect IP 11

Under typical use, no maintenance and almost no care is required. Only the coolant's reservoir level (water tank) should be checked from time to time.

Only use Innovatec Protect IP for the pco.aquamatic!

Do not use or add any other coolant or normal water. If you need to add cooling liquid in order to maintain the tank level, contact PCO for additional supply.

The coolant will turn yellow after some hours of operation. This is normal and not a sign of wear or malfunction. The optimum pH-value is between 8 and 9 (check this value if you are concerned about the coolant's quality).

NOTE

The recommended service interval for the change of the coolant is four years.

A4.2 FIRST TIME INSTALLATION



Ensure the unit is placed on a flat and firm surface. Do not cover the cooling vents of the unit. Make certain there is free airflow around the pco.aquamatic for maximum cooling performance. All tubes and power cords must run kink-free.

Before installation of the unit, carefully read the Innovatek Protect IP safety datasheet (see [Innovatek Website](#)).



outlet flow



inlet flow

Follow Steps 1 – 6

- 1 Connect tubes to cooling unit and camera. The two arrows on the housing of the cooling unit only indicate flow direction. Either connection of the camera can be used for *in* or *out*.
- 2 Connect to power.
- 3 Open tank cover.
- 4 Turn power switch on (I).
- 5 Slowly fill with coolant while the unit is running. Refill as needed to keep the level.
- 6 While the cooling liquid flows back to the tank, make sure all air leaves the system – this takes a few minutes (move hoses if necessary).

The cooling liquid tank is full when liquid level is approximately 1-2 cm from the top of the tank. The integrated pump only works when the pump chamber is completely filled. To ensure this, move hoses or remove air by evacuating. Tank capacity is approximately 500 ml.

After steps 1 – 6 are successfully completed, the system is ready for operation.

NOTE

The hose connectors are waterproof when not connected. They may lose small amounts of cooling liquid while not in use. There is no need to empty the hoses while storing the camera system.

A4.3 OPERATION



To begin, connect the power out of the cooling unit with the power in of the pco.edge camera with the *PCO WAT camera cable*.

The cooling unit provides two operation modes.

Operation Mode on: the cooling unit turns on and provides permanent power to the camera. The camera can be switched



on and off as needed.



Operation mode follow: the cooling unit turns on when the camera is switched on and vice versa.

Error Codes

The coolant temperature sensor is located in the coolant tank.

Temperature	Action
27°C	fan turns off
36°C	fan turns on
55°C	warning message
60°C	error message

If a warning level is passed, the Power LED blinks slowly, and the Error LED displays the error code. If a failure level is passed, the Power LED blinks rapidly, and the Error LED shows the error code.

 power	 error	Error / Failure
on	off	none
1Hz flash	one short flash	warning when temperature at 55 °C (or sensor is defect or missing)
2Hz flash	one short flash	failure when temperature at 60 °C
1Hz flash	two short flashes	fan speed (also, if a high deviation of the standard value is reached)

NOTE

The camera has its own protection circuit and will shut down Peltier cooling automatically when the electronics temperature exceeds the safety level. The camera itself will continue running, but sensor temperature will increase. (valid for air and water cooling!)

If the camera and the water cooler have a different power supply, always shut down the camera first and then the cooling system to avoid damages.

A4.4 DIMENSIONS

All dimensions are in millimeters.

Weight: 4kg (with filled coolant tank)

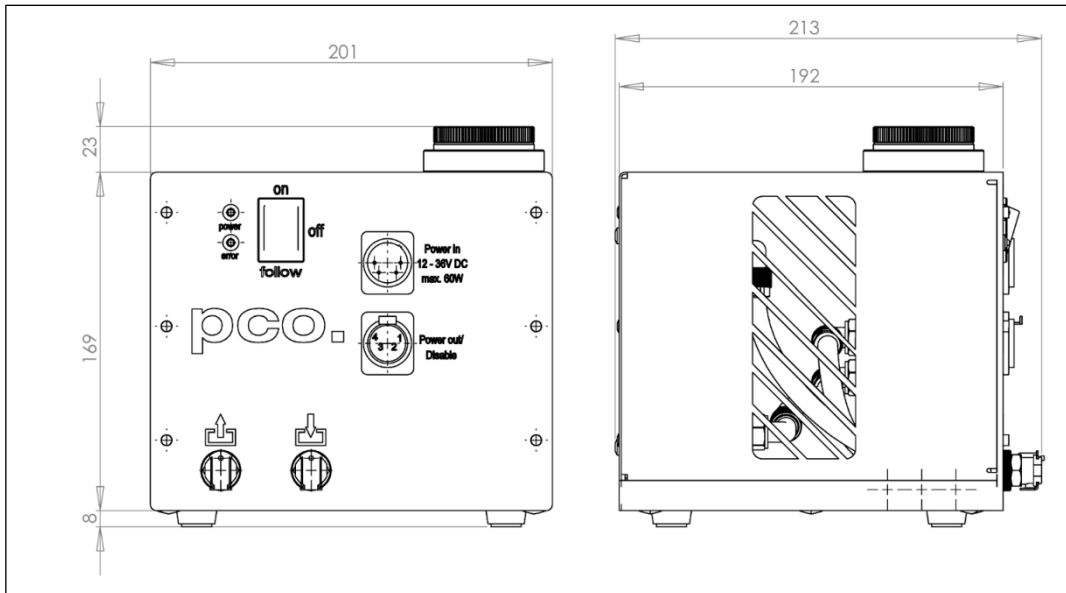

A4.5 USING YOUR OWN COOLING SYSTEM

You are not obliged to purchase the pco.aquamatic system — you may use your own water cooling device. A separate power supply will be provided to every pco.edge camera with water connection. The hardware of the pco.edge cameras with USB 3.1 interface is designed to work with or without a water cooling system. A fan inside the camera provides adequate cooling for most use cases.

When using your own water cooling system, make sure the liquid you use to cool your camera is always **ABOVE** the dew point of the ambient temperature. In order to avoid any damage from condensation, use a cooling liquid at room temperature.

- A liquid flow rate of 1–2 litres per minute is sufficient
- Always use Innovatec Protect IP cooling fluid or an equivalent cooling fluid

A5 CUSTOMER SERVICE

A5.1 SERVICE

The camera is designed to operate with no need of special adjustments or periodic inspections.

A5.2 MAINTENANCE



CAUTION

UNPLUG CAMERA BEFORE CLEANING

Risk of injury due to electric shock!

- Unplug the camera from any power supply before cleaning it.

NOTICE

CLEANING

- Use a soft, dry cloth for cleaning the camera.
- Do not clean the input window, unless it is absolutely necessary. If necessary, carefully clean it with pressurized air.
- Be careful to avoid scratches and damage to the input window surface.
- Do *not* use liquid cleaners or sprays.

NOTICE

LENS CLEANING

- The lens is best cleaned with pressurized air or with liquid cleaners such as pure alcohol or with special optical cleaners that are available at high quality photo stores.
- Use a cotton swab dipped in pure alcohol or optical cleaning liquid and wipe only the glass surface.
- Do not get any cleaning liquid on the metallic parts such as the lens thread. Doing so may result in tiny detached particles that may scratch the surface.

NOTICE

CLEANING LIQUIDS

Aggressive cleaning liquids can damage your camera.

- Never use aggressive cleaning liquids such as gasoline, acetone, spirits or nitro cleanser.
- Every time the input window is cleaned, there is the possibility of surface damage.

NOTICE

PROTECTIVE CAP

Always store the camera with the protective cap or with a lens mounted to avoid dust and dirt on the input window.

A5.3 RECYCLING



If you wish to dispose of your camera, return it to PCO or take it to a local recycling center.

The camera includes electronic devices that may contain materials harmful to the environment. These electronic devices must be recycled properly.

A5.4 TROUBLESHOOTING

If you have a question not adequately addressed in this manual, contact PCO or your local dealer.

How to Create Logfiles

Enable Logging ①

Open **? Help** menu, select **Logging** and then **Enable Logging**. The pco.camware will ask you to press **YES ②** to activate **Logfiles** after a restart of the software.

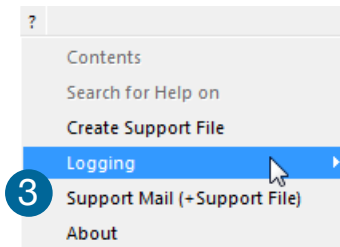

Enable Logging ①

Clear Logfiles

Explore Logfiles

Disable Logging

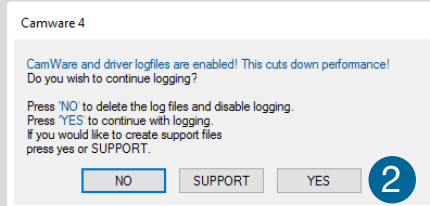

Repeat Workflow

The workflow that produces the error must be repeated while logging is enabled.

Support Mail (+Support File) ③

Open **? Help** menu, select **Support Mail (+Support File)** and a support file with all necessary files is created.

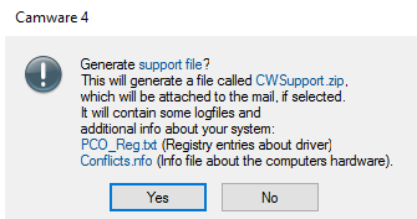

The pco.camware opens a new email addressed to support@pco.de. For North American support, contact support@pco-tech.com. Attach the **Support File** manually to this mail and send to PCO support.

Alternatively, you can use the support form on our website: <http://www.pco.de/support/> (or <https://www.pco-tech.com/support/> for North America) and upload the support file.

To Speed up Your Request

Provide us with the following information:

- A detailed description of your problem
- Your specific application
- Your camera:
 - Type and version
 - Serial number
- Your setup:
 - Software version
 - Operating system
 - Processor and memory
 - Graphics card

Firmware, Software and Driver Update

You will find all necessary software and drivers on the accompanying USB storage device. For the latest versions check the PCO website (<https://www.pco-tech.com/>).

A6 INDEX

NOTE:

The page listed is always the starting page of a chapter!

Keyword	Chapter	Page
Camware installation	4.2	9
Cleaning	A5.1	28
Components camera system	3	6
Cuda Nvidia driver	4.1	8
Data sheet	A1.1	17
Dimensions	A1.2	18
Driver installation	4.1	8
F-Mount	A3	22
First Image	5.3	11
Global Shutter	6	12
Hardware I/O Control	7.1	14
Input / Output possibilities	7.1	14
Installation	4	8
Live preview	5.3	11
Logfiles	A5.4	29
Maintenance	A5.2	28
Mounting	A2.2	21
Rear connections	A1.3	19
Recycling	A5.3	28
Safety instructions	2	5
Support	A5	28
Troubleshooting	A5.4	29
USB card installation	A2.1	20
USB driver installation	4.1	8
Water Cooling	A4	24

ABOUT PCO



pco.

pco.history

“PCO” stands for what we are: a Pioneer in Cameras and Optoelectronics. With 30 years of expert knowledge and experience, PCO has forged ahead to become a leading specialist and innovator in digital imaging for scientific and industrial applications such as life and physical science, high-speed imaging and machine vision.

PCO’s success dates back to the 1980s and a research project of the founder, Dr. Emil Ott, who was working at the Technical University Munich for the Chair of Technical Electrophysics. While performing measurements with intensified slow scan cameras, Dr. Ott realized that the existing standard did not meet the sophisticated requirements of scientific applications – and so PCO came to life in 1987.

With a small team of engineers Dr. Ott began to develop his first image intensified camera followed by several variations on the original model, geared to overcoming the existing flaws and surpassing standards of the day. During these early years, PCO developed a now well-established core of advance technologies used as the foundation to develop cutting edge products.

In the early 1990s PCO expanded its business activities to the global market by successfully establishing an international network of highly trained sales partners and customers. We entered additional fields beyond traditional scientific research expanding the potential for our cameras’ applications in life science, automotive testing and even broadcasting. This step paved the way for a wide range of innovative highlights:

As of 2017, PCO has three decades of technical know-how and expert knowledge in the development and manufacturing of high-performing camera systems. In-house competence of all significant technical disciplines and partnering with leading image sensors manufactures ensures cutting edge sCMOS, CMOS and CCD technology for all PCO cameras.

pco.prospect

“If you want to do something special, particularly in the high-end fields, you have to develop your own image sensors. So we work with partner companies who develop tailored sensors made especially for us. This is something we are doing continuously, so we’re already working on the next generation of cameras that we will introduce in the coming years” – Dr. Emil Ott.

In PCO’s first 30 years, Dr. Emil Ott took a company that he started right after finishing university and has built it into a major player in scientific and industrial cameras – and there’s plenty more to come.

pco.

An Excelitas Technologies Brand