

image TEMA

PRODUCT DESCRIPTION

INTRODUCTION

TEMA Motion is the world leading software for advanced motion analysis. Starting with digital image sequences the operator uses TEMA Motion to track objects in images, make analysis of the movement and present results in tables and graphs. The flexible windows based user interface makes it fast and easy to find the best setup for your application. The User Interface is fully synchronized: any change of parameters or setup will directly affect all parts of the tracking session, updating results, graphs and tables.

The operator can choose between a large number of subpixel tracking algorithms and track an unlimited number of points through the image sequence. The system handles all major image formats on the market. A lens calibration system is included to compensate for lens inaccuracies, which is necessary for high accuracy and traceable results. The result can be presented in any of a large number of predefined graphs and tables. Free scaling for print outs makes it very easy to design reports or images.

TEMA Motion has a number of options available, e.g. 3D, 6DOF, Shape analysis, Viewer and Camera control.

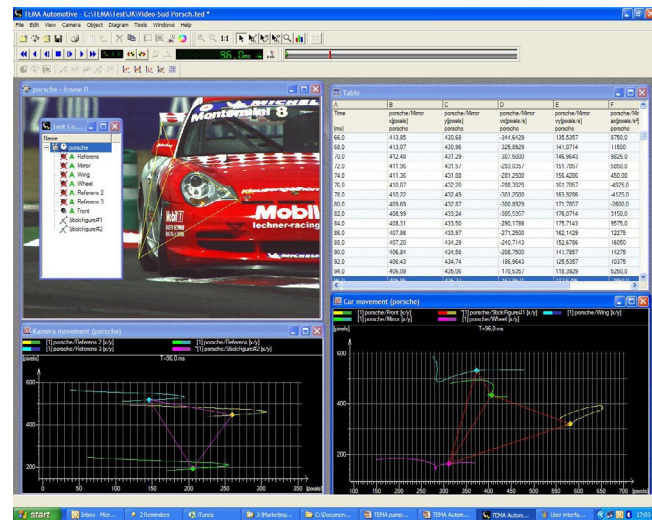
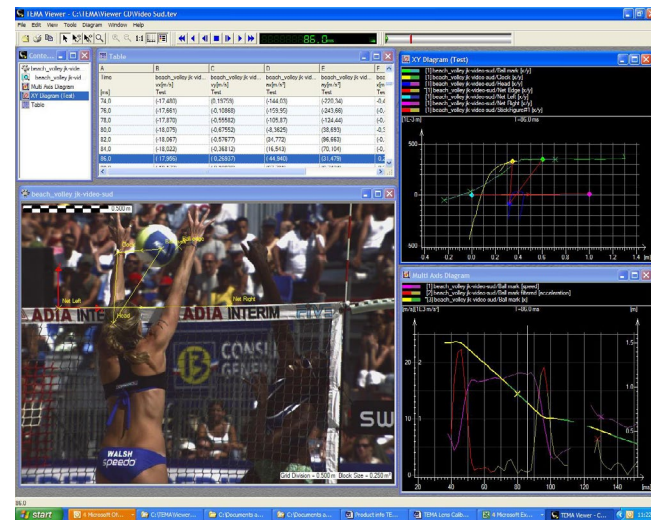

A VASTE VARIETY OF APPLICATIONS

AUTOMOTIVE INDUSTRY

BACKGROUND

The automotive sector is subjected to performed vasste security analysis of their products and sub-systems. Examples of research and quality control measurements that needs to be performed are airbag deployment, impact testing, crash testing, engine testing, and much more. Image analysis can also be used for optimizing sub-systems such as engine control, bumpers, seatbeats and other moving items within the system.

SOLUTION

Depending on the expected test results, TEMA Automotive+3D+6D+Airbag and a set of cameras makes a powerful and highly cost-effective automotive 3D measurement system, suitable for the majority of the applications applications foreseeable wihtin the automotive sector. TTEMA is EURO-NCAP compliant and covers the complete process from bringing the image into the program via automated tracking and analysis to a result presentation in predefined tables and graphs. Measurements of deformations, airbag volume, dummy head accelerations and steering column penetration are just a few of many applications in the automotive industry. All the results are automatically synchronized with the images. It is also possible to import external data from other sensors, accellerometers, etc, using the data import option, and have it synchronized for a multisensor analysis. The results are

DATA PRESENTATION

The acquired data can be exported to an image sequence, as well as tables and graphs of all kinds, for easy-to-use presentation possibilities. It can also be exported to a wide range of data formats for post-analysis.

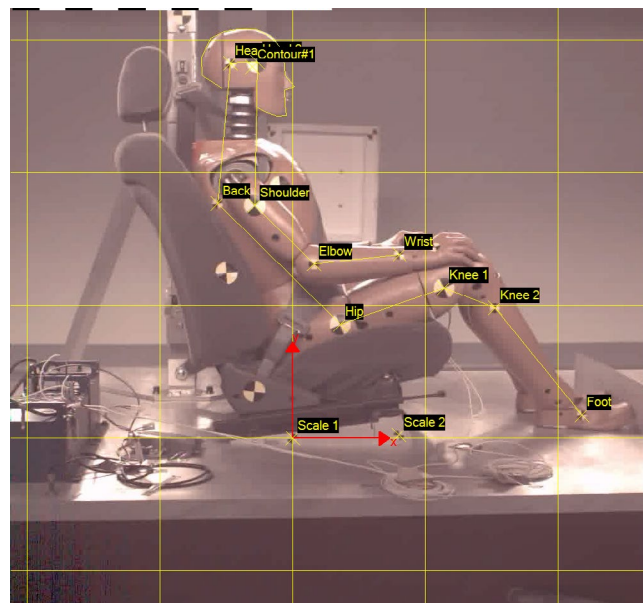
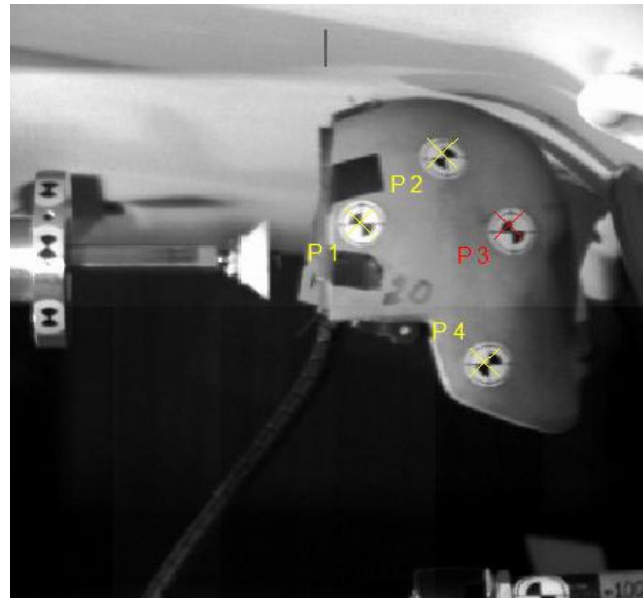

The screenshot displays the TEMA Automotive software interface. The main window shows a video frame of a red Porsche race car with various tracking points. A 'Test Co...' window lists tracked objects: porsche, Referens, Mirror, Wing, Wheel, Referens 2, Referens 3, Front, StickFigure#1, and StickFigure#2. Below the video, there are two graphs: 'Kamera movement (porsche)' and 'Car movement (porsche)'. The 'Car movement' graph shows the trajectory of different car parts over time.

Time [ms]	porsche/Mirror x[pixels]	porsche/Mirror y[pixels]	porsche/Mirror vx[pixels/s]	porsche/Mirror vy[pixels/s]	porsche/Mirror ax[pixels/s²]
66,0	413,85	430,68	-344,6429	135,5357	8750,0
68,0	413,07	430,96	-325,8929	141,0714	11500
70,0	412,48	431,29	-307,5000	146,9643	9825,0
72,0	411,96	431,57	-293,0357	151,7857	5850,0
74,0	411,36	431,88	-281,2500	156,4286	450,00
76,0	410,87	432,20	-288,3929	161,7857	-4925,0
78,0	410,22	432,49	-301,2500	163,9286	-4125,0
80,0	409,69	432,87	-300,8929	171,7857	-2600,0
82,0	408,99	433,24	-305,5357	176,0714	3150,0
84,0	408,31	433,50	-290,1786	175,7143	9575,0
86,0	407,86	433,97	-271,2500	162,1429	12275
88,0	407,20	434,29	-240,7143	152,6786	16050
90,0	406,84	434,58	-208,7500	141,7857	14275
92,0	406,43	434,74	-186,9643	125,5357	10375
94,0	406,09	435,06	-170,5357	118,3929	5250,0
96,0	406,85	436,77	167,8571	112,7286	2850,0

FIREARM ANALYSIS

BACKGROUND

Firearm developers are continuously looking for new innovative solutions to improve their products (e.g. pistols, rifles, machine guns). Whether the purpose is hunting, sport or military, key characteristics of a firearm include its accuracy and functional reliability: A gentle recoil has a significant impact on the shooter's experience and performance, and automatic and semi-automatic firearms always face the challenges of unintended firing (i.e. slamfire) and jamming due to a failing bolt action. Traditional testing of firearms is often limited to trial-and-error tests, resulting in long and costly development cycles.

SOLUTION

The combination of a modern high-speed camera and TEMA provides a testing system with many advantages.

- Modern high-speed cameras can record 5000+ frames per second in 1 MPixel resolution, resulting in a direct visual understanding of the test.
- Analysis of parameters like recoil angle and bolt mechanism displacement, velocity and acceleration is based on automatic tracking of markers and features on the firearm.
- No instrumentation needed. Good for testing prototypes, great for testing factory samples.
- Subpixel tracking provides excellent spatial resolution. Displacement can be measured with up to ± 0.04 mm accuracy in a 200 mm window, using 1 MPixel images. (Scales linearly for larger windows.)
- Analysed data is inherently synchronized with the images. As an option it is even possible to import external data from other sensors, e.g. gas pressure sensors, into TEMA, in order to synchronize all available data for analysis.
- An option is available for 6DOF analysis. 6DOF is used to analyse the displacement of the firearm's centre of gravity in 3D (x, y, z), as well as its attitude angles (roll, pitch, yaw). The 6DOF technique requires multiple markers on the firearm, but only one camera.

DATA PRESENTATION

The analysed data can be plotted in tables and graphs of all kinds, as well as be exported to image sequences for easy-to-use presentation possibilities.

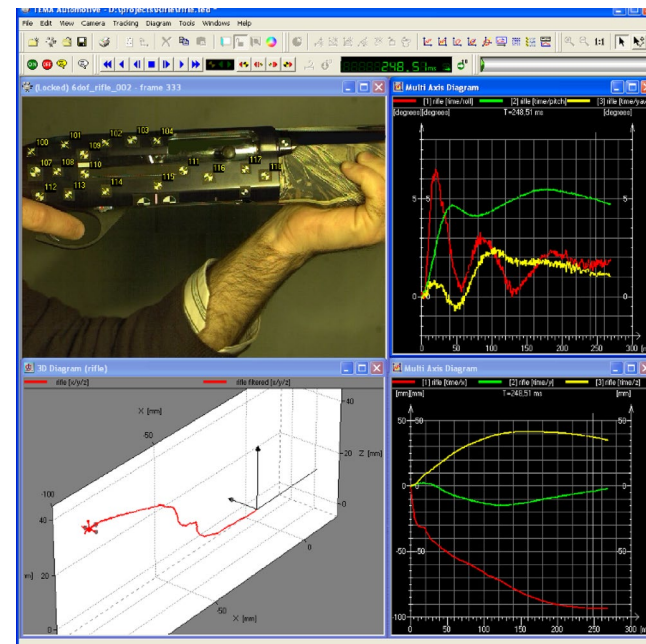

FUEL INJECTION ANALYSIS

BACKGROUND

Liquid propellant engines in the automotive, aerospace and defense industries are based on injection of a propellant (i.e. the fuel) into a combustion chamber, where the propellant is ignited to generate energy. Important parameters for achieving a stable and effective combustion include the size and distribution of the injected fuel droplets. A modern high-speed camera, capable of 5.000+ frames per second in 1MPixel resolution, combined with image-based analysis software, is a great tool for analysing the droplets and the fuel injection process.

SOLUTION

By combining a modern high-speed camera and TEMA it is possible to do a complete image-based analysis of the fuel injection process. The camera is setup to have a narrow depth-of-focus, so that only the injection muzzle and the droplets in the same plane are in focus during the image acquisition. TEMA is used for post-analysis of the captured images. The droplets are automatically identified in defined detection areas, and analyzed for properties like position, area and rotational symmetric volume. TEMA is fully flexible, with user settings for the detection areas and droplet criterias (such as size and contrast). All results are scaled from pixels to lab units by using the dimensions of the muzzle for scaling reference. An obvious benefit of an image-based motion analysis system is that the measured data is inherently synchronized with the images. It is even possible to import external data from other sensors into TEMA, in order to synchronize all available data for analysis.

DATA PRESENTATION

The acquired data can be exported to an image sequence, as well as tables and graphs of all kinds, for easy-to-use presentation possibilities.

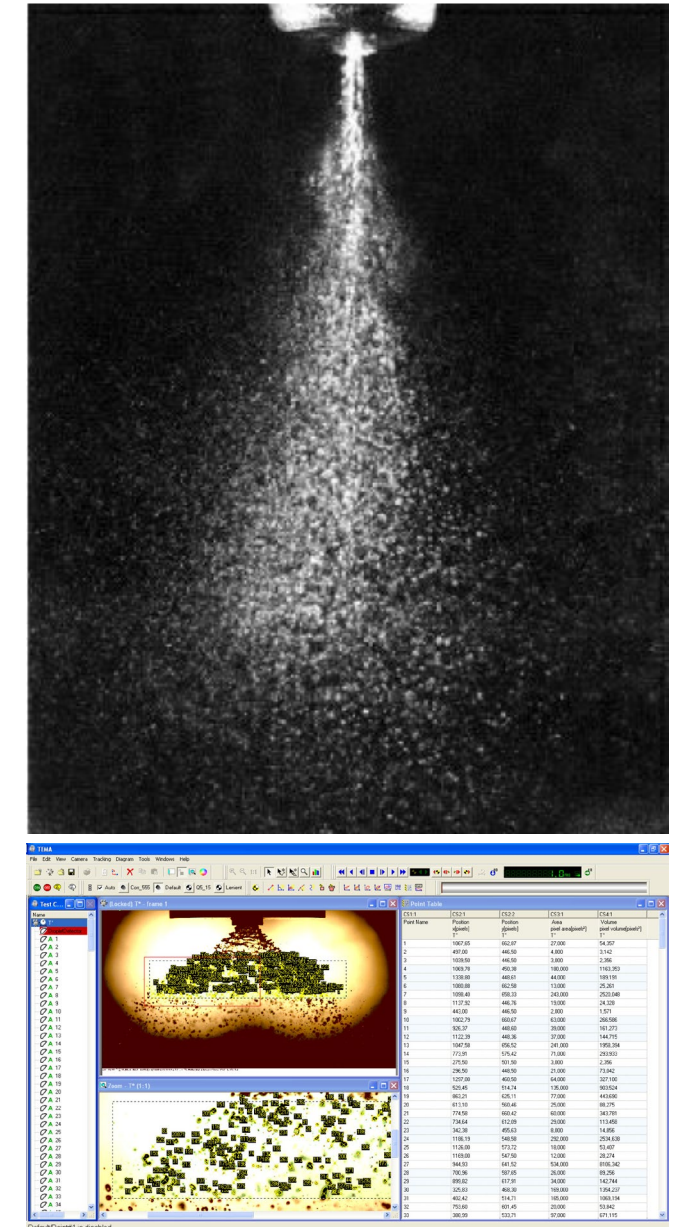

SHAPE ANALYSIS

BACKGROUND

Shape analysis is performed in a wide range of applications. This paper is focused on shape analysis of ballistic gelatins, waterjets and explosions. These three applications include very fast dynamic events where the shape of an object is an important property that needs to be understood and controlled by repetitive tests. In R&D departments, the test results are feeded back into the research process. In production plants, the results are used to test the product for consistency and quality.

BALLISTIC GELATIN TESTS

A projectile (i.e bullet) is fired into a block of gelatine, sometimes passing through a protective material. Properties of interest in the tests include statistics such as length, width and volume of the temporary cavity in the gelatine, as well as projectile propagation speed and direction. These tests are commonly conducted in the defense industry, for development of ammunitions, weapons and protective armours.

WATERJET TESTS

High velocity and pressure waterjets have many applications in the industry, such as such being used for cutting, shaping, carving and reaming. The key property of the waterjet is that it retains a specific shape when used. Shape properties include spread angle, area and thickness at different locations along the jet. These tests are critical for waterjet research laboratories.

EXPLOSIONS

The shape, size and explosive effect of an explosion depends upon a large number of factors. Properties of interest in a test include total area of explosion as well as propagation speed along defined lines

SOLUTION

By using the combination of TEMA and a high speed camera it is possible to do a dynamic shape analysis in 2D or 3D of all three tests outlined above, as well many other applications. The shape of the object is captured in each frame using a basic or an advanced outline tracker. These trackers are developed to handle complex dynamic backgrounds, variable shading, and free shape forms. Based on the outlines, TEMA then computes displacements of extreme points and intersections between the outline and virtual lines. TEMA also computes the area, circumference and major axis angle of the shape. Additionally, the velocities and accelerations of all properties listed are readily available. Spread angles are measured by tracking the nozzle and the boundary of the spray/jet/etc at a defined location. TEMA also has options to perform the shape analysis in 3D using multiple cameras.

Key benefits:

- Non invasive measurements of dynamic shape properties.
- High measurement sample rate with a modern highspeed camera.
- Advanced subpixel tracking and lens calibration for outstanding accuracy in measurements.
- Robust automatic and semi-automatic tracking and processing of shapes.
- All measurements are scaled (e.g. to meters) and relative to a user defined coordinate system.
- User friendly interface and template based workflow.

DATA PRESENTATION

of all kinds, as well as be exported to image sequences for easy-to-use presentation possibilities.

Right page above: Screenshot of waterjet analysis

Right page below: Screenshot of ballistic gelatin analysis

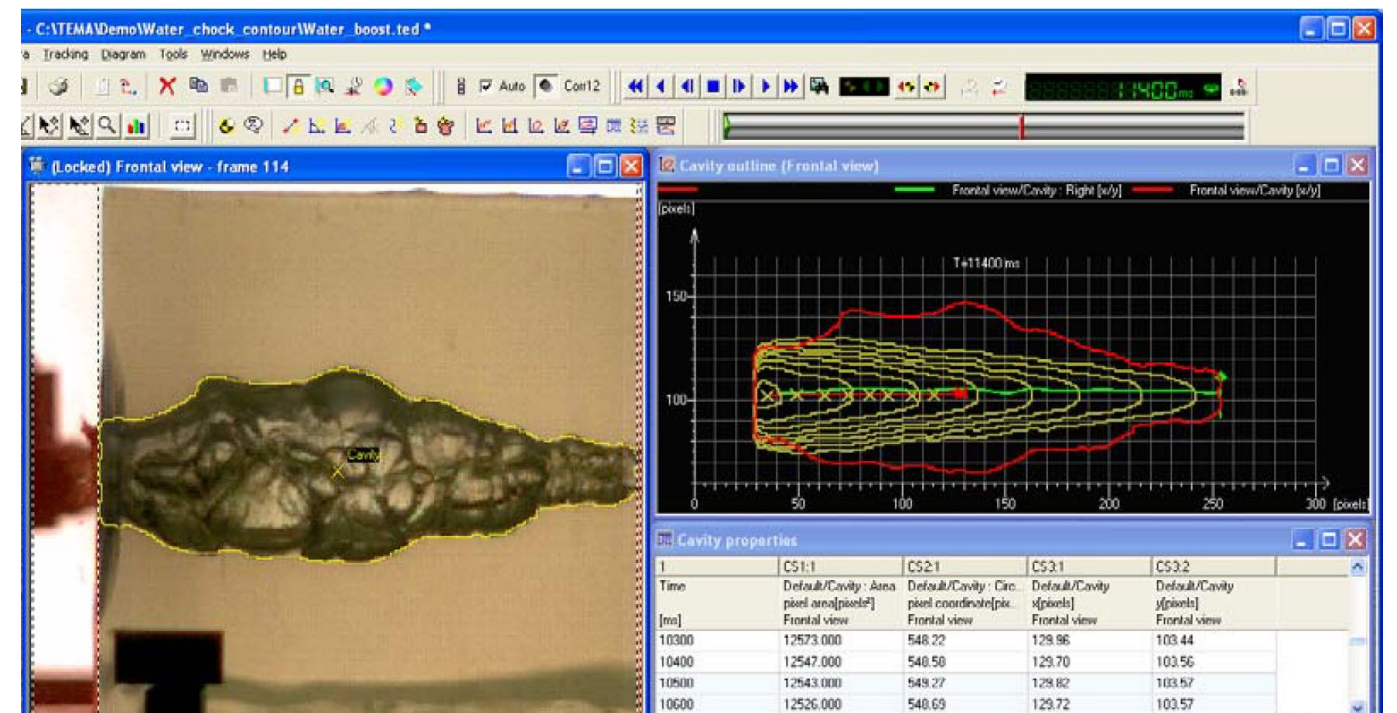
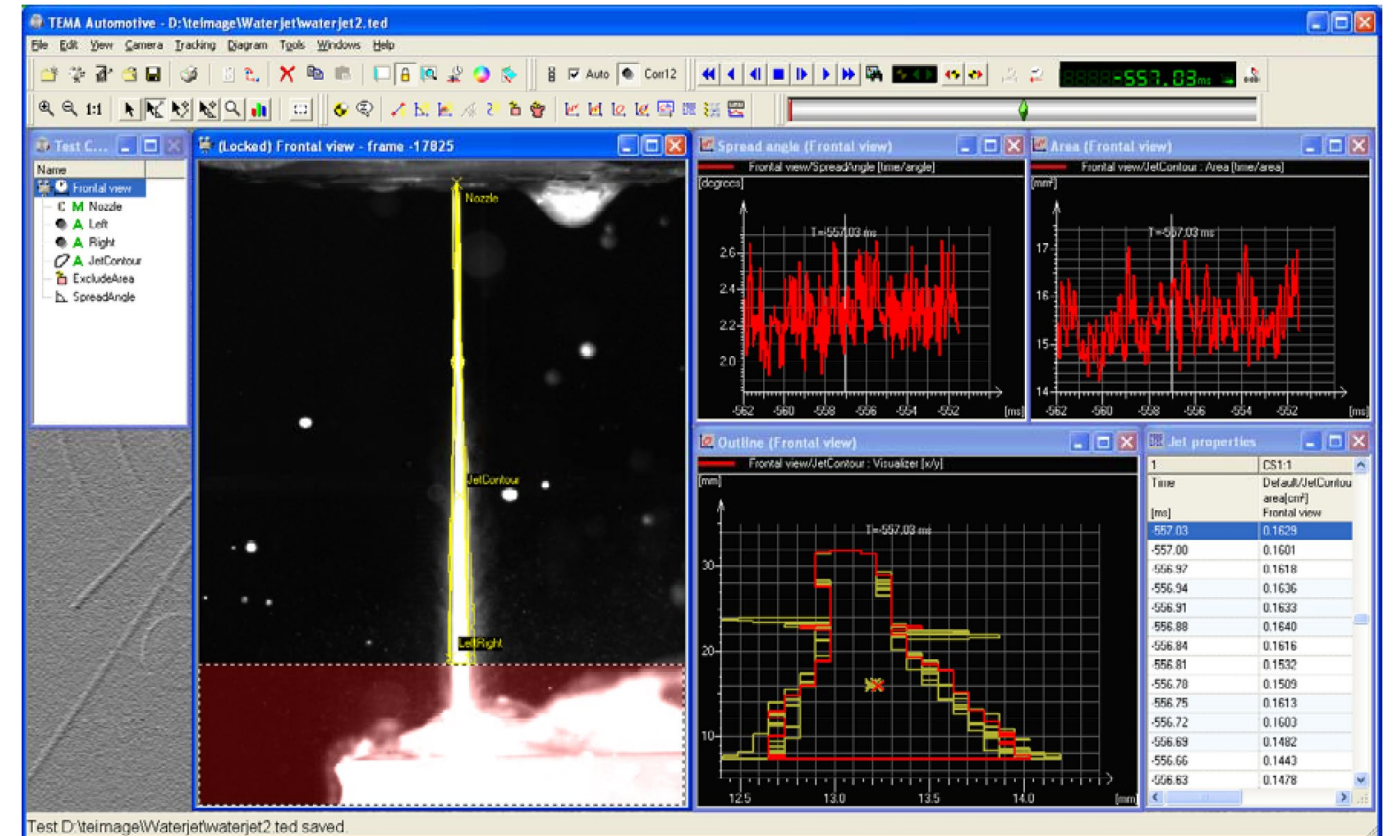

SEWING MACHINE ANALYSIS

BACKGROUND

Both industrial and household sewing machines of today are computer controlled and use X-Y stepper motors or sequential cams to achieve very complex patterns. As the machines are becoming faster and more complex, the need for sewing machine companies to use high-end motion analysis becomes even more important; In a production line to ensure and improve the product quality, and during R&D to validate or develop new product designs.

SOLUTION

By using the combination of a high-speed camera and TEMA it is possible to do a complete 2D motion analysis of any part of a sewing machine: When e.g. analyzing the X-Y fabric positioning system of a sewing machine, TEMA accurately calculates the position, speed and acceleration of the fabric relative to the needle. An obvious benefit of a visual motion analysis system is that the measured data is synchronized with the images. It is even possible to import external data from e.g. accelerometers attached to the sewing machine into TEMA, in order to synchronize all available data.

Test operators who prefer visual inspection of deviations to raw motion data will also find a great benefit in TEMA: Using motion overlays, the movement is both faster, easier and more accurately inspected.

For analysing non-planar movement such as the 3D position of the tip of the needle, relative to the fabric, a system consisting of TEMA 3D and two cameras is the best option. This system delivers a full 3D result in sub-pixel resolution.

DATA PRESENTATION

The acquired data can be exported to an image sequence, as well as tables and graphs of all kinds, for easy-to-use presentation possibilities.

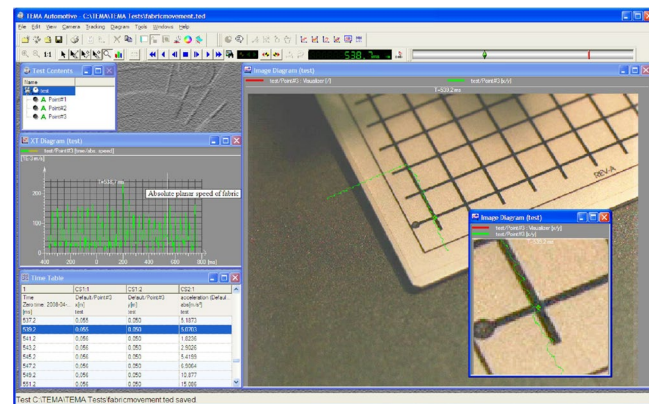

WELDING ANALYSIS

BACKGROUND

In welding, metals (or thermoplastics) are joined together in a strong joint by coalescence. The joint is formed when a weld pool, consisting of melted metal and an added filler, solidifies. Welding is a fundamental process in many industries, and researchers today are continuously challenged with finding new techniques to improve the weld quality and at a lower cost. Modern high-speed cameras, capable of 5000+ frames per second in 1MPixel resolution, combined with visual analysis software, is a great new addition to the tools available for researching the welding process.

SOLUTION

By combining a modern high-speed camera and TEMA it is possible to do a complete visual analysis of the welding process. The camera is setup to record the weld pool from a full frontal view, and TEMA is used for post-analysis of the captured images. By analysing the test, it is objectively parameterized, and the result can be fed back in the research process. The parameters calculated with TEMA include: feeding speed of filler, welding pool shape, droplet speed and shape, etc. Using a scale reference, all parameters are computed in lab units, e.g. meters.

An obvious benefit of a visual motion analysis system is that the measured data is synchronized with the images. It is even possible to import external data from other sensors into TEMA, in order to synchronize all available data for analysis.

DATA PRESENTATION

The acquired data can be exported to an image sequence, as well as tables and graphs of all kinds, for easy-to-use presentation possibilities.

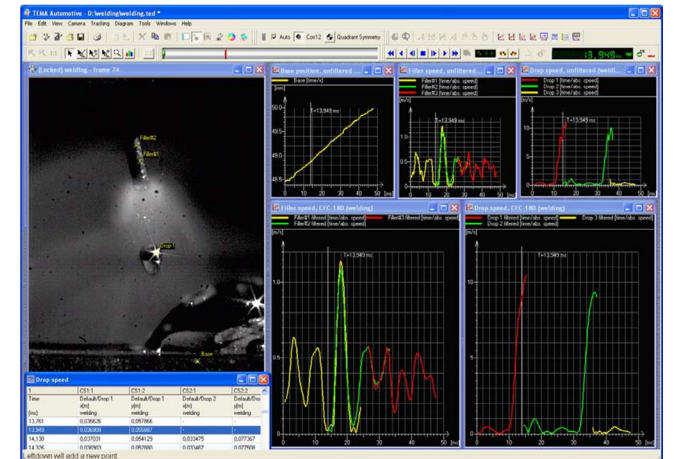

BIOMECHANICS

BACKGROUND

Biomechanics is the application of mechanical principles on living organisms. Examples of biomechanics research include gait analysis, sports science, aerodynamics of birds, insect flight and hydrodynamics of swimming in fish. In sport science, it applies the laws of mechanics and physics to human performance, in order to gain a greater understanding of performance in athletic events through modeling, simulation, and measurement.

SOLUTION

TEMA Motion+3D and a set of cameras makes a powerful and highly cost-effective biomechanical 3D measurement system, suitable for applications like human motion analysis, etc. The cameras are set to capture synchronized images from different angles, and TEMA is used to perform the full 3D analysis based on the images. For the highest degree of automation and accuracy the test subject should be equipped with markers. However, a major benefit of TEMA is that it also can handle test subjects without markers, making it robust and suitable for a wider range of applications. All the results are automatically synchronized with the images. It is also possible to import external data from EMG-sensors, force plates, etc, using the data import option, and have it synchronized for a multisensor analysis.

DATA PRESENTATION

The acquired data can be exported to an image sequence, as well as tables and graphs of all kinds, for easy-to-use presentation possibilities. It can also be exported to a wide range of data formats for post-analysis.

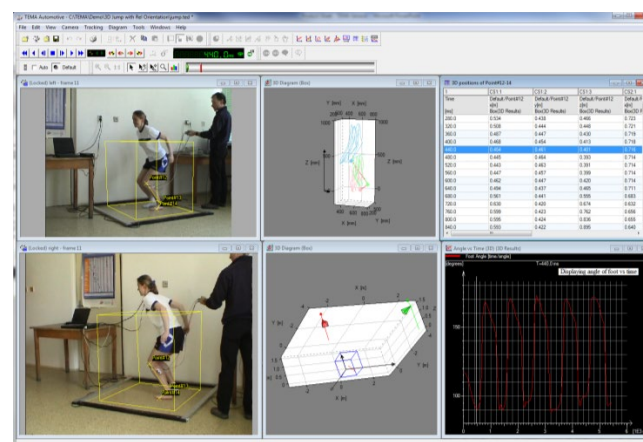
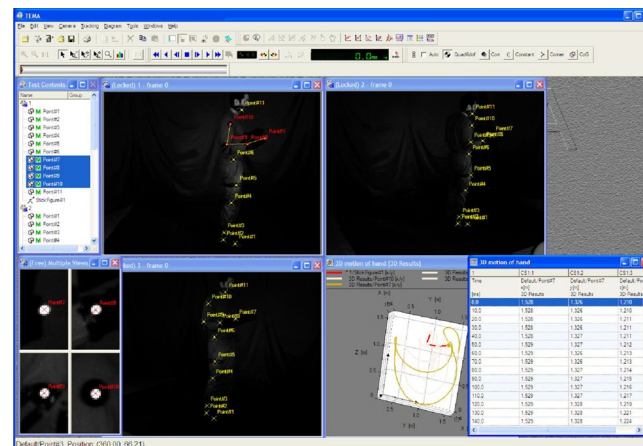

SYSTEM DESCRIPTION

USER INTERFACE

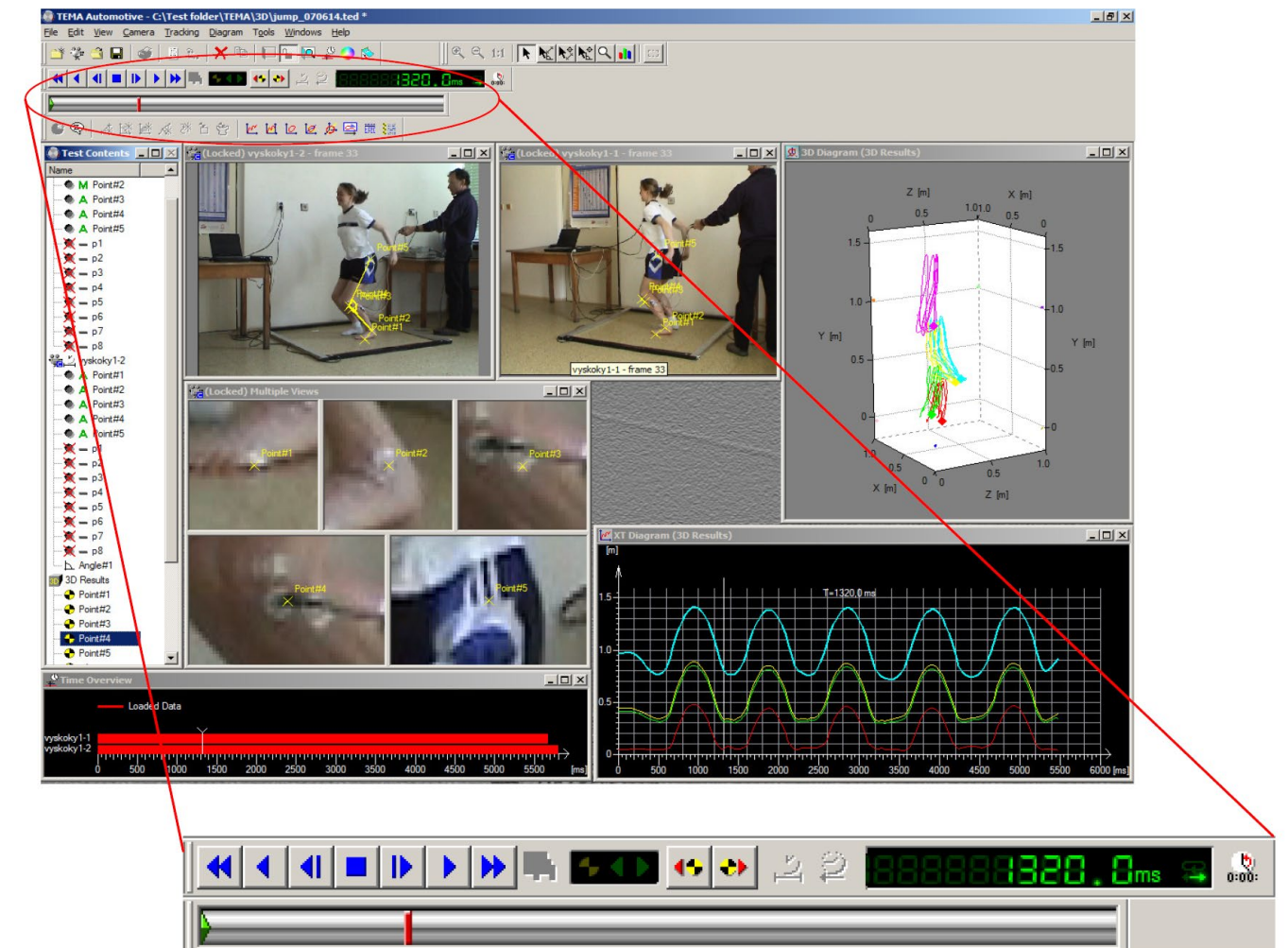

The windows based user interface of TEMA Motion provides a very flexible way of setting up a test. The operator can easily load one or multiple camera views and define which points to track in each image sequence.

The user interface is fully synchronized; there is only one current time in a test. Changing a parameter, clicking on an interesting value in a table or moving the time slider to an interesting position on a curve will automatically update all windows and show the corresponding image in the image sequence, curve or table.

The time panel gives a perfect control and overview of playing and tracking the image sequence. Step by step, normal speed or fast-forward: All are supported in both directions.

TRACKING

The tracking function operates in two dimensions and produces 2D pixel coordinates in subpixel resolution for each tracked target point in each image.

Multiple image sequences can be tracked simultaneously and the output plotted in the same graph or spreadsheet.

Different applications have very different requirements on how to track a defined target. The image quality and appearance of the target could vary which means that different tracking algorithms and a robust tracking framework is needed to work efficiently.

The setup of the tracking is done per point or per tracking algorithm, allowing multiple points selection.

Tracking can be performed in B/W, colour, individual colour bands (red, green and blue) and enhanced images. Bit depths up to 16 bits are supported. This is important also when tracking in 8 bit images, as no information is lost if the images are enhanced.

The operator has full control of the tracking in TEMA with many possibilities to adjust for different applications. The tracking can be made Manual, Semi Automatic or Automatic.

AUTOMATIC TRACKING

The operator set a tracker tolerance, which specifies how much variation in the target features that should be tolerated. TEMA Motion then tracks all targets frame by frame until the end of the sequence. If the tolerance can't be met the tracking stops and the operator is prompted to give the correct position.

SEMI AUTOMATIC TRACKING

TEMA suggests a position for each target frame by frame and the operator either confirms or adjusts it.

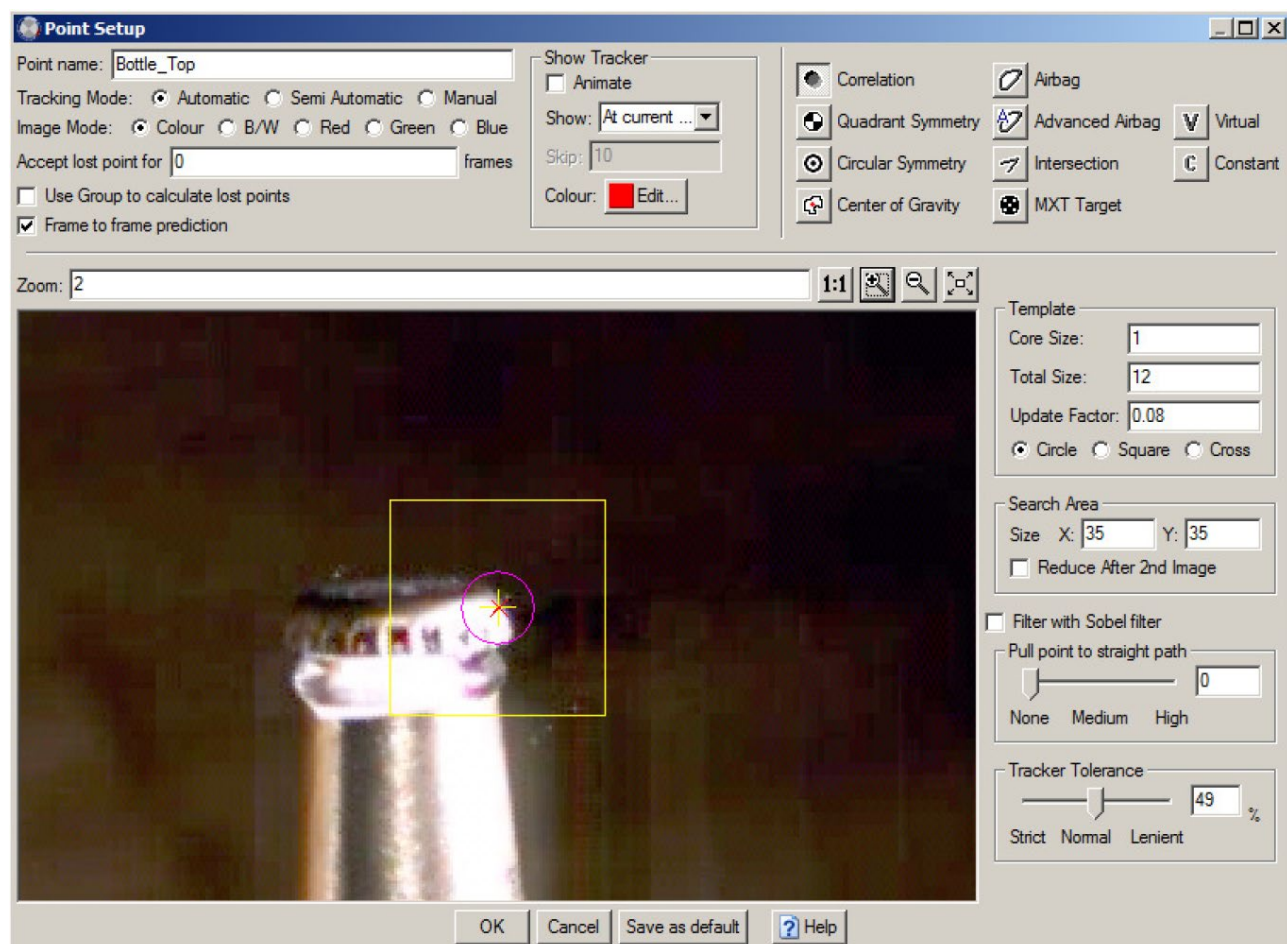

TRACKING ALGORITHMS

TEMA Motion has a number of different tracking algorithms available for different applications. All take advantage of the tracking framework and track in subpixel resolution. *The basic outline tracker* analyses threshold values to find the color or grey scale difference between the body and the background. To capture object shapes in test setups with a complex background, an image subtraction can be done. This will convert all non-moving parts of the image into pitch black. *The advanced outline tracker* looks for edges between different surfaces. This is often used when the color or grey scale difference between the object and the background varies, or when the background is complex and dynamic.

CORRELATION

Looks in each successive image for the area that correlates best with the pattern defined in the first image. This method is applicable to most cases, as it doesn't require a marker.

QUADRANT

Finds the symmetry centre of quadrant targets and is invariant to rotation, scale and shading. Quadrant targets are recommended for applications with high demands on accuracy and automation.

CIRCULAR SYMMETRY

Finds the symmetry centre of the image within the search area and is applicable to concentric circles, spokes on a bicycle wheel or combinations thereof.

CENTER OF GRAVITY

Tracks the center of gravity of the contour of a marker or an object. The shape of the target may vary in the sequence and is captured with a user-defined intensity threshold.

VIRTUAL POINTS

Specifies that the point is virtual, i.e. its position in successive images is calculated from the positions of the other points in its target group, rather than by measurement. For instance it can be used to define a part of a rigid body that is not visible in the image sequence.

INTERSECTION TRACKER

Tracks intersection points (corners) on any object shape. The intersections are between extrapolated straight lines applied on the object shape.

OUTLINE TRACKER

Captures an object boundary to provide an outline around a body. There are two different outline tracker options; one basic and one advanced.

MXT TRACKER

Finds the symmetry centre of the target. The user can set the target to 1+4 and 1+5 MXT target tracking.

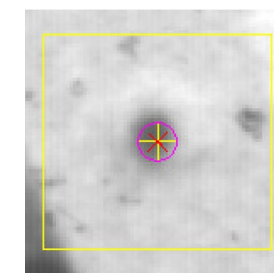

Correlation tracker

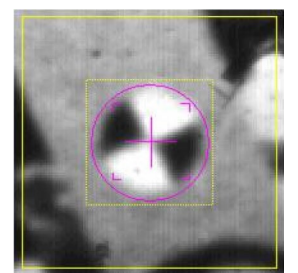

Quadrant tracker

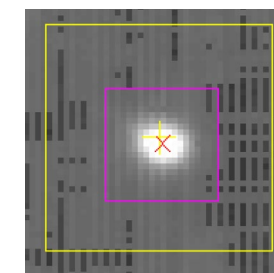

Circular symmetry

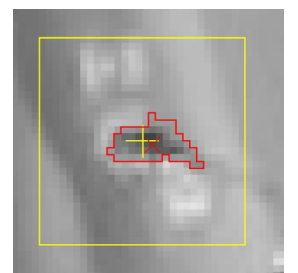

Center of gravity

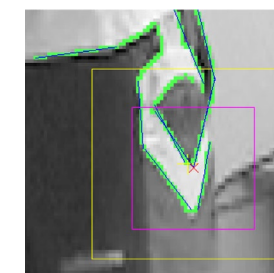

Intersection tracker

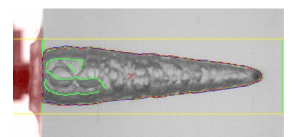

Advanced outline tracker

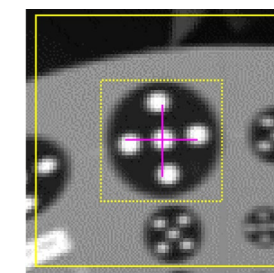

MXT tracker

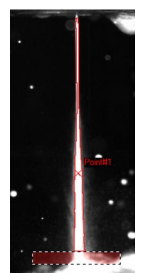

Basic outline tracker

TRACKING FEATURES

SUGGESTED TARGET POINT POSITION

To be used in an application where the same 2D target model is used at all times. The operator gives the position for one of the target points and TEMA Motion positions the rest of the target points in the image in relation to the first placed point.

AUTO FIND SIMILAR

To be used in applications where a lot of similar types of patterns are to be tracked in an image sequence. The operator defines the suitable tracking setup for one of the patterns. TEMA will then find other patterns that applies to the same tracking setup and apply a tracking point to each of those patterns.

AUTO FIND NEW POINTS

This function is auto find similar but over time in a sequence. To be used in applications where new, static tracking targets appears subsequently in a sequence. The operator defines one such target when visible. At the following tracking, TEMA will apply a new tracking point to each new target that appears that applies to the setup.

ANALYSIS

Analysis of properties like position, velocity and acceleration are automatically calculated for all points in the session. The operator can also define properties like angles and distances between tracked points. The system will then automatically calculate distance, angles, angle velocities and angle accelerations between related points.

MOTION PLANES AND SCALING

The user can at any time rescale raw pixel data into units of measurement by specifying the properties of the motion plane, i.e. the plane in which the object is moving. Thanks to the fully synchronized interface, all data and plots in the entire test will update instantly.

TEMA Motion supports test setups with a single motion plane that is parallel with the camera sensor. Support for advanced setups with multiple and/or angled planes are available as options.

The scale can be setup as static or dynamic, meaning a scale is computed for each individual image. Non-

USER DEFINED COORDINATE SYSTEMS

Based on tracked points, the user can define multiple new coordinate systems to express tracking data and analysis results.

A user-defined coordinate system can be dynamic, i.e. follow the movements of objects, which opens up new possibilities to effectively analyse otherwise complex movements.

It is also possible to rectify and stabilize an image sequence by displaying it in an image diagram using a dynamic coordinate system.

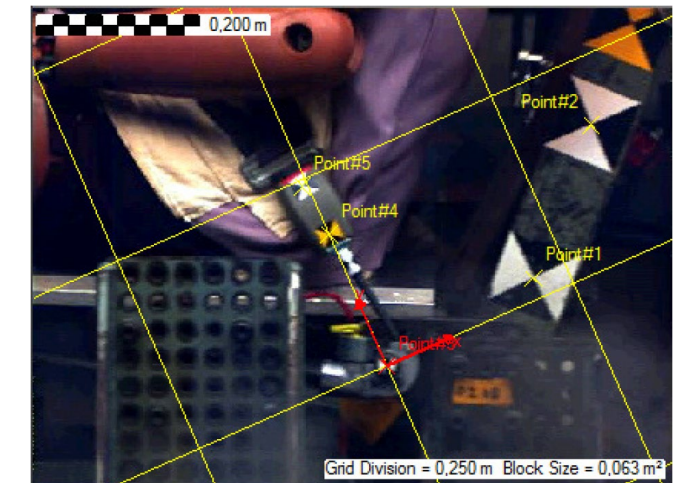
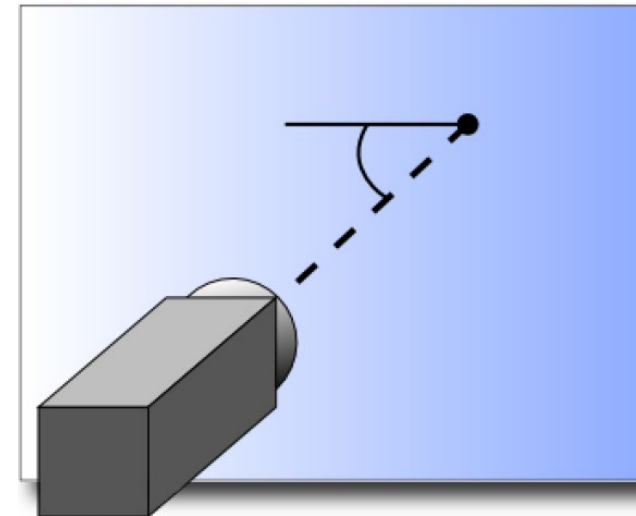

3D ANALYSIS

TEMA Motion 3D takes the analysis from 2D on the screen to 3D in the real lab. By tracking the object from two or more cameras, the analysis is carried out in 3 dimensions using the concept of intersection. The target observations (tracked 2D pixel coordinates) and poses of the cameras are used to compute the 3D position of the target as the best fit to the observations.

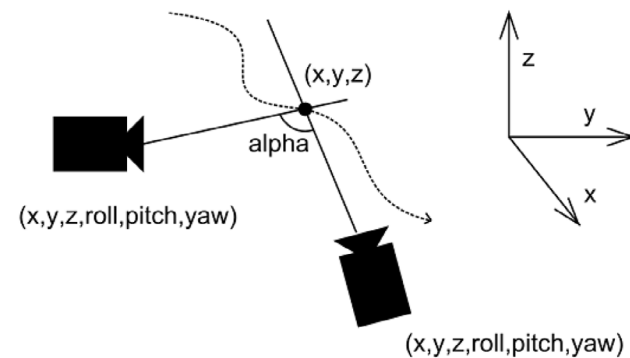
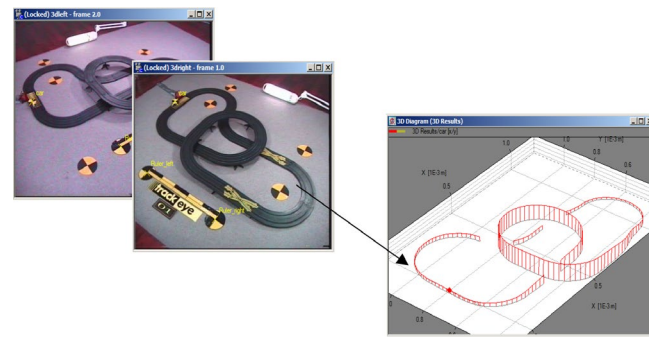

Two different methods are available to calibrate the camera poses: absolute and relative camera orientation. With absolute orientation a few points with surveyed coordinates are used for reference. With relative orientation it is sufficient to identify a few common points of the camera views for reference and add a scale, i.e. there is no need for any coordinate measurement equipment or cumbersome and restricting calibration fixtures.

As a consequence, measurement volumes of any size are supported.

3D from moving cameras is supported by tracking the reference points in the image sequence.

6D ANALYSIS

With the use of only one camera, TEMA Motion 6D can calculate the real orientation and position of any rigid object.

The position of a rigid body can be described with six parameters: three positions coordinates (x, y and z), which gives the position of a specific point on the body, and three attitude angles (roll, pitch and yaw), which gives the orientation in space. The term 6DOF, or 6D position of the body, refers to these six parameters.

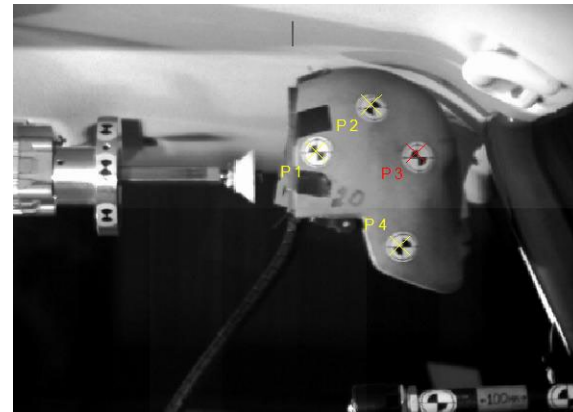

Tracking in 6 degrees of freedom (6DOF), also known as 6-dimensional (6D) tracking, is an optional feature that computes the position and orientation of a rigid body from a single camera view.

LENS CALIBRATION

The inaccuracy of a lens is called lens distortion, and all lenses have it built-in to a certain degree. The distortion is most prominent for wide-angle lenses, where images of straight lines become visibly curved. Great accuracy improvements and traceable results are obtained by correcting the image data with a calibrated mathematical model of the distortion.

The calibration is normally performed prior to the test and the result is saved to a file. It is possible to save calibration results for many different camera/lens combinations. During the actual test the operator then chooses which lens calibration to apply.

Using a series of images of a flat calibration pattern in different angles, the calibration is performed in an automated wizard. The output is the focal length and distortion of the lens, as well as the principal point of the sensor.

The calibration pattern can be printed from an included file. There is no requirement on surveying the printout: using a high-quality printer and attaching the printout to a flat surface is sufficient for most applications. Though for the highest accuracy possible, we also have a calibration board (sold separately) available.

WAND CALIBRATION

NO SETUP TIME - NO PREPARATIONS

No need to place reference markers or doing surveys of the measurement volume in order to do the calibration. Just pick up the TEMA Wand and start recording.

QUICK AND EASY TO USE

In a couple of minutes the user has the results from the calibration and can move towards performing the real test. The software 100% automatically performs all procedures to obtain the calibration data.

AUTOMATIC CALIBRATION CONTROLS

By using active marker based on LED technology, combined with a very robust tracking algorithm, the software calibration process is fast, robust and provides a high level of accuracy.

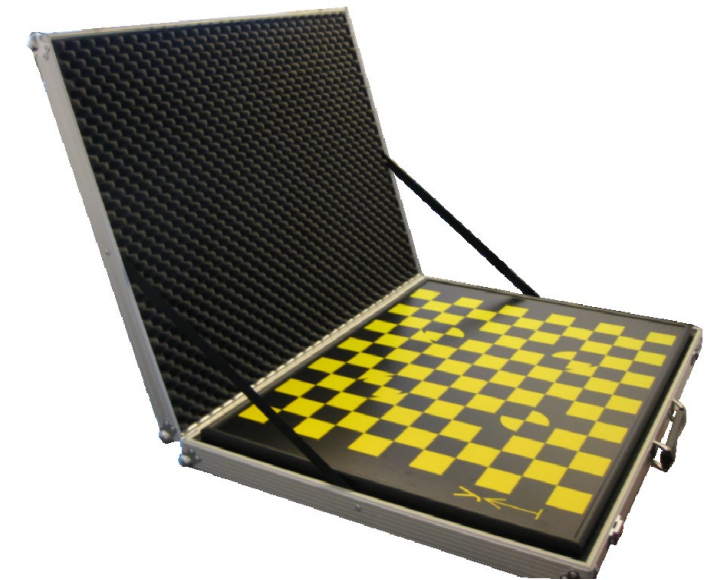

TOOLS AND ACCESSORIES

IMAGE ENHANCEMENT

In order to enhance tracking and/or reviewing an image sequence, TEMA Motion contains a complete Image Enhance functionality. RGB waveform diagram and vectorscope helps to improve properties like color balance, contrast, brightness and gamma correction in the image. The enhanced image sequence can be saved or imported to other image formats after adjustments.

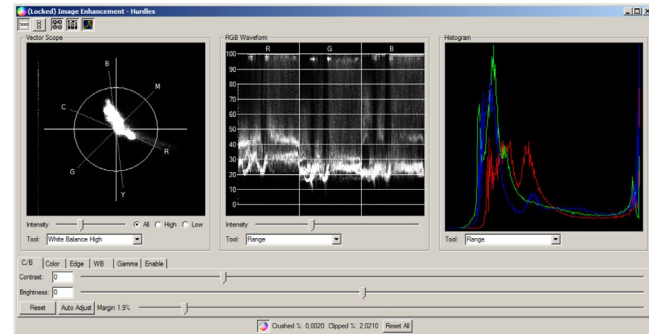

EVENT FINDER

The Event finder identifies and finds one image or an interval of images of interest out of a whole sequence.

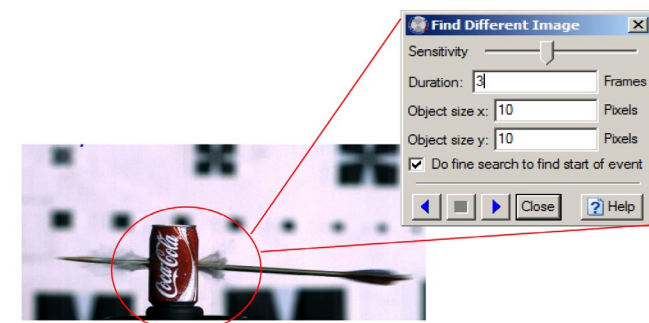

DATA IMPORT

TEMA imports several different standard data formats like DIADEM, ISO13499, HDF, ISO-2, SDAS, DELL as well as custom specific ASCII data formats.

The imported data is available for all parts of the program and can be used in calculations, graphs and tables.

DATA EXPORT

After tracking and analysis, the result can easily be exported to several different formats like Excel, CASDAS, DIADEM, ISO, Matlab or ASCII files.

IMAGE SEQUENCE IMPORT

TEMA Motion software uses digital image sequences as input for the analysis. Most raw formats from high speed cameras and a large number of compressed digital formats can be read: AVI, TIFF, BMP, JPEG, MPEG2 and many others. TEMA is continuously updated to support new image formats when they became available.

IMAGE SEQUENCE EXPORT

All image sequences can be exported from TEMA, with or without overlaid tracking data. The Image Export can be extensively customized:

- Settable image size, format, sequence time range and skip count.
- A title slate can be added, acting as the first frame of the exported sequence.
- This can be specified with any describing text.
- Text box overlays on the exported sequence, including text and interactive information like the time for each frame, operator name etc.

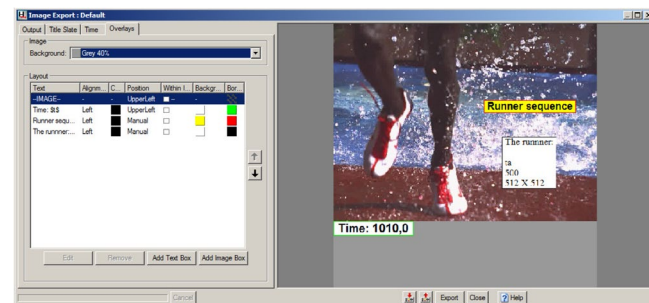

PRESENTATION

REPORTS AND DIAGRAMS

TEMA motion can present the analysis data and results in a variety of customized graphs and tables. It is easy to add comments and add custom graphics to customize the appearance of a certain view or plot. The main tools for presentations are:

3D DIAGRAMS

Included in 3D and 6DOF options. Plot 3D, 6DOF and camera data on 3 axes in a rotatable 3D box. The plot can also be equipped with curtains to enhance the understanding of the 3D data.

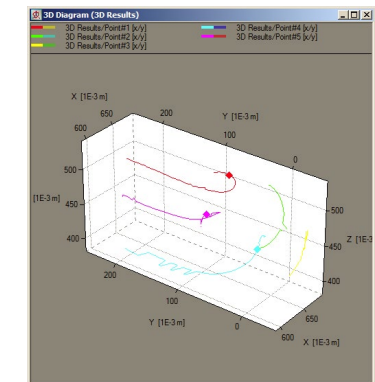

2D DIAGRAMS

Plots data against time or other data (X/Y-diagrams). All data, whether tracking data, or data input separately, can be plotted in single or multi axis X/T or Y/X plots with many options to customize.

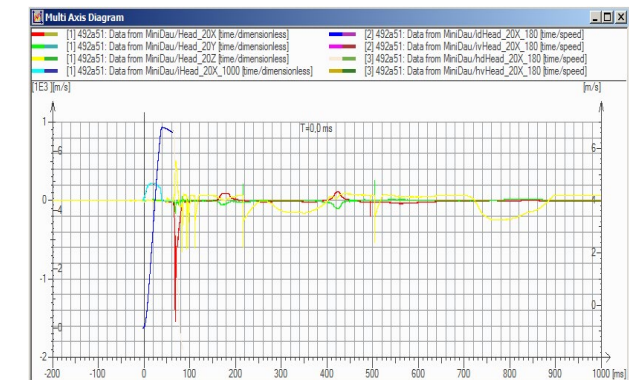

TIME TABLES

All type of data can be presented in tabulated form using rows and columns. The rows will be time indexed. The diagram can easily be customized with different headers or combination of data. The row of the current time will always be highlighted.

IMAGE DIAGRAMS

Plots data as overlays on top of image sequence from the tracking view. It is also used to rectify and stabilize images.

POINT TABLES

All type of data can be presented in tabulated form using rows and columns. The rows will be indexed per point added to the table. The data in each cell will then update according to the current time. The diagram can easily be customized with different headers or combination of data.

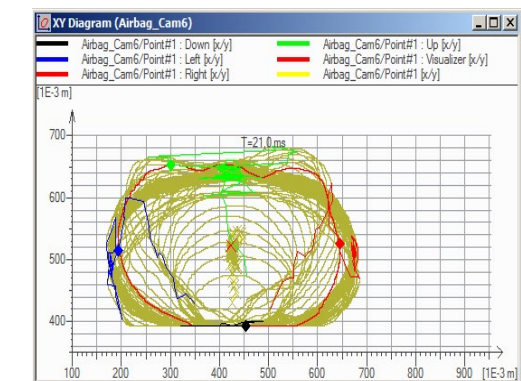

REPORT GENERATOR

Framework to populate a whole set of graphs and tables from a test that can be output using one single command.

Point Name	Position (xpixels) vyskoky1-1	Position (ypixels) vyskoky1-1	Position (velocity) x[pixels/s] vyskoky1-1	Position (velocity) y[pixels/s] vyskoky1-1
Point#5	404,35	493,49	37,946	-94,071
Point#4	408,05	344,09	1,750	-111,527
Point#2	413,49	231,37	17,661	-106,393
Point#1	408,12	196,92	-36,179	-101,036
Point#3	412,71	333,33	3,134	-111,884

TEMA VIEWER

A TEMA Motion test can be exported to a self-running CD that allows the recipient to rerun the tracking with the images, graphs and spreadsheet data synchronized. Just like in TEMA Motion itself. Data from the viewer can in its turn be copied into another document. The TEMA Viewer does not require any extensive program installation to run. Also, the same Viewer can be loaded onto a network for shared use. There are two versions of the Viewer, basic and advanced.

BASIC VIEWER

The user can only review the data using the current graphs and tables. The basic viewer can also export the result.

ADVANCED VIEWER

The advanced has all the functionality as the basic viewer, but the user can also add new graphs and tables to the setup. Still, no new data can be added.

HARDWARE REQUIREMENTS

The TEMA Motion system runs on standard stationary PC or a Laptop. The minimum requirements are:

	MIMINUM	RECOMMENDED
OPERATING SYSTEM	Windows 2000/XP/VISTA/7/8	Windows XP/7
CPU	2.0 GHz	3.0 GHz
RAM	1GB	4GB
SYSTEM DISK	100GB	100GB
IMAGE DISK	Not required	200GB
GRAPHICS	>19" @ 1280 x 1024	>19" @ 1280 x 1024
CD / DVD	CD	CD/DVD

Please note that the required performance specified above only apply for running the TEMA Motion analysis software. Higher performance is normally needed if the system is TEMA camera control for high-speed digital cameras.

CONFIGURATIONS

TEMA STARTER

“Basic analysis without markers”. For basic applications where markerless tracking is sufficient. Allows tracking of 5 points with correlation tracker. Possible to plot points and make tables of positions, velocity and acceleration. Some additional scaling functionality.

OPTIONS

PART NUMBER	DESCRIPTION
TEMAADD5P	5 additional points (increasing the total number of points to 10).
TEMAQUADTRK	Tracking quad markers.
TEMACIRCTRK	Tracking circular markers.
TEMACOGTRK	Tracking centre of gravity of contours.
TEMADATAIMP	Import of data files like Diadem, ISO, ASCII.
TEMAIMAGEXP	Export of images (AVI, TIFF and others).

TEMA LITE

“High accuracy analysis using markers”. For applications where accuracy, repeatability and automation are important. Consists of Starter plus quad tracking, X/Y diagrams and export of data.

OPTIONS

PART NUMBER	DESCRIPTION
TEMAADD5P	5 additional points (gives a total of 10).
TEMAUNLMTDP	Unlimited number of points.
TEMACIRCTRK	Tracking for circular markers.
TEMACOGTRK	Tracking centre of gravity of contours.
TEMADATAIMP	Import of data files like Diadem, ISO, ASCII.
TEMAIMAGEXP	Export of images (AVI, TIFF and others).
TEMACOORDSYS	User-defined coordinate systems.
TEMAVP	Virtual points.
TEMAMULTVIEWS	Multiple camera views.
TEMAMULTMP	Multiple motion planes (a.k.a. depth scaling).
TEMAANGMP	Angled motion planes.
TEMASTICK	Stick figures and contours.
TEMAPOINTABLES	Presentation in Point Tables.
TEMAMXTTRK	Tracking MXT markers.
TEMAOULTRK	Outline Tracking, including two additional tracking algorithms.
TEMAVIEWER	Viewer.
TEMAVIEWERADV	Advanced Viewer.
TEMAFREQ	Frequency analysis.
TEMAMOUSERK	Mouse tracking.

TEMA 2D

“The world leading system for advanced motion analysis”. For advanced applications where the highest level of accuracy and functionality is required. Lens calibration is included. TEMA 2D comes in 2 different configurations; 1) TEMA Motion and 2) TEMA Automotive

PART NUMBER	DESCRIPTION
TEMADATAIMP	Import of data files like Diadem, ISO, ASCII.
TEMAMULTMP	Multiple motion planes (a.k.a. depth scaling).
TEMAANGMP	Angled motion planes.
TEMASTICK	Stick figures and contours.
TEMAPOINTABLE	Presentation in Point Tables.
TEMA3D	3D Module.
TEMAWAND	Software for 3D wand calibration. A user-friendly and efficient 3D calibration tool.
TEMA6D	6D Module.
TEMAMXTTRK	Tracking MXT markers.
TEMAOULTRK	Outline Tracking, including two additional tracking algorithms.
TEMAVIEWER	Viewer.
TEMAVIEWERADV	Advanced Viewer.
TEMAMOUSERK	Mouse tracking.
TEMAAIRBAGB	Airbag analysis. Including algorithms: Basic Airbag and Advanced Airbag tracker.
TEMAAIRBAGVOL	Airbag Volume (Includes Airbag Analysis).

FEATURES

Date: 3.8				
TEMA version: 3.8				
Features (● = included, ○ = available as option)	TEMA Starter	TEMA LITE	TEMA Motion	TEMA Automotive
Tracking algorithms				
2D Tracking	●	●	●	●
Correlation	●	●	●	●
Quadrant		●	●	●
Circular		○	●	●
Center of gravity		○	●	●
Constant			●	●
Intersection			●	●
Corner contour			●	●
Advanced circle			●	●
Tracking features				
Number of points to be tracked in one session	5	5	unlimited	unlimited
Tracking in 16bit/BW/color/R/G/B and automatic/manual	●	●	●	●
Interpolation of hidden points	●	●	●	●
Virtual points		○	●	●
Exclude areas	○	○	●	●
Image subtraction (tracking feature)				
Suggest reference point position	○	○	●	●
Autofind similar point	○	○	●	●
Autofind new points (Point generator)	○	○	●	●
Automatic point group finder	○	○	○	●
Frequency Analysis		○	●	●
Mouse tracking		○	○	○
Import / Export				
Export of diagrams and images to Word and Excel	●	●	●	●
Import of images (AVI, TIFF, MPEG, JPEG and others)	●	●	●	●
Export of data files like Diadem, ISO, ASCII	○	●	●	●
Export of images (AVI, TIFF and others)	○	○	●	●
Import of data files like Diadem, ISO, ASCII	○	○	○	●
Motion planes and scaling				
Manual scaling	●	●	●	●
Dynamic scaling	●	●	●	●
Static scaling	●	●	●	●
Multiple planes (i.e. depth scaling)	○	○	○	●
Angled planes		○	○	●
2D coordinate systems				
User defined coordinate systems		○	●	●
Translation of origin		○	●	●
Rotation (axes definition)		○	●	●
Rotation (offset angle)		○	●	●
Visualization of coordinate systems		○	●	●
Diagrams and tables				
Time Table	●	●	●	●
X / T diagram	●	●	●	●
Copy to Time Table	●	●	●	●
X / Y diagram		●	●	●
Multiple axes (4 axes) X / T diagram			●	●
Advanced X / Y diagram			●	●
Image diagram			●	●
Frequency Analysis		○	●	●
Point table			○	●
3D diagram			(Included in 3D and 6D options)	(Included in 3D and 6D options)

Diagram Features				
Individual setting of horizontal and vertical axis	●	●	●	●
Legends	●	●	●	●
Copy to TimeTable	●	●	●	●
Printing of diagrams to printer	*)	*)	●	●
Text boxes			●	●
Setting of measurable scales in diagram printouts			●	●
Printing of logotypes, test comments			●	●
Contour plotting			○	●
Stick figure plotting			○	●
Corridors				●
*) only through copy and paste to Word document				
Report				
Report Generator				●
Analysis and Calculations				
Filtering of data CFC / FIR / Spline	●	●	●	●
Velocity and acceleration	●	●	●	●
Angles between points	○	●	●	●
Distances between points	○	●	●	●
Contour analysis	○	○	○	●
Lens calibration				
Lens calibration			●	●
Image handling				
White balance	●	●	●	●
Printing of images to printer	*)	*)	●	●
Image enhancement		○	●	●
Image stabilization / rectification		○	●	●
Digital signature				●
*) only through copy and paste to Word document				
Other				
Event finder	●	●	●	●
Fully synchronized user interface	●	●	●	●
Point zoom	●	●	●	●
Test templates	●	●	●	●
Setting of default units	●	●	●	●
Number precision	●	●	●	●
Free setting of Reference Time t0	●	●	●	●
Multiple camera views		○	●	●
Macros				●

IMAGE SYSTEMS



IMAGE SYSTEMS

Ågatan 40 | SE-582 22 Linköping | Sweden
info@imagesystems.se

www.imagesystems.se